

EXCAVATIONS AT GÎZA

1929—1930

[This page is intentionally blank.]

THE EGYPTIAN UNIVERSITY

EXCAVATIONS AT
G Î Z A
1929—1930

by

SELIM HASSAN

with the Collaboration of
FOAD BOGHADY

Published by

THE FACULTY OF ARTS OF THE
EGYPTIAN UNIVERSITY

OXFORD

PRINTED AT THE UNIVERSITY PRESS
BY JOHN JOHNSON

1932

PRINTED IN GREAT BRITAIN

PREFACE

THE Necropolis of Gîza has attracted the attention of Egyptologists for more than a hundred years. During the nineteenth century many explorers worked in different parts of it, clearing tombs here and there, and in some cases unfortunately leaving no record of their discoveries. At the beginning of the present century it was divided up by the Egyptian Government into three sections which were allotted by the Service des Antiquités to explorers from America, Germany, and Italy. Then, for the first time, excavations were begun on a scientific basis. The area behind the Pyramid of Cheops, as well as that west of the Pyramid of Mykerinos, was allotted to America. The central part with the area west of the Pyramid of Chephren was reserved for Germany. The southern portion and the area to the west of the Pyramid of Cheops was given to Italy. In 1912 the German concession was shared by Austria, and before 1914 the Italians abandoned their section. During the Great War only the Americans carried on researches at Gîza.

At the conclusion of the Great War the concessions were re-arranged by the Service des Antiquités. Austria was given an area to the west and south of the Pyramid of Cheops, and the ground which remained unexplored of the former German concession was reserved for the Department of Antiquities. Part of the original Italian concession was allotted to the University of Harvard and the area to the west of the Sphinx that had been reserved by the Antiquities Department was later handed over to the Egyptian University. It is the record of the first year of the Egyptian University's explorations at Gîza that forms the subject of the present volume.

In the winter of 1927 I visited Professor Junker who was then exploring the ground to the west of the Great Pyramid and the idea occurred to me that the Egyptian University might undertake excavations in that part of the necropolis which had been reserved by the Service des Antiquités. I then expressed my desire to the University authorities, and, after some conversations, it was agreed that I should join Professor Junker at Gîza and be trained by him in the work of excavating. Accordingly, in 1928, I spent three months at Professor Junker's camp, and my University then applied, through M. Lacau, to the Comité d'Égyptologie, for the concession of the area that had been reserved for the Department of Antiquities to the west of the Sphinx. The application was at once granted and I have to thank M. Lacau for his kind help in this matter.

The Egyptian University excavations at Gîza were begun in December 1928 and continued to April 1929. They were carried out with the help of twenty experienced workmen from Kûft under the Re'îs Saddîk Sa'id. These men, with their Re'îs, were most generously placed at my disposal by Professor Junker, Director of the German Institute of Archaeology in Egypt. To him I desire to express my grateful thanks, first, for having trained me in the work of excavating, and secondly, for enabling me to begin exploring under the most favourable conditions with his expert Re'îs and workmen.

At the beginning of the season I had about seventy local workmen in conjunction with those from Kûft and these were engaged in carrying away debris and in working the Decauville railway. The number of workmen and boys was soon afterwards increased to about 200. The

photographic record was made by Ismaïl Shehab of the Cairo Museum. The drawing record was begun by Yûsef Effendi Khafâga, who was later replaced by Ibrahîm Effendi Khalîl of the Ministry of Public Works. The pottery record in water-colour was made by Ahmed Effendi Abd El-Monem, one of the graduates of the School of Egyptology in the Egyptian University; this record will be published in a future volume. Sharkâwi Effendi of the Ministry of Public Works, and Abd El-Monem Effendi Haikal also helped in completing the record in water-colour. The plans and sections were made by Morris Effendi El Mangabâdi and Ibrahîm Effendi Khalîl, both of the Ministry of Public Works.

Foad Effendi Boghdady, my Assistant, has been most useful during the whole season. Not only has he been of great help to me from the scientific point of view, but he did all the clerical work in the most able manner. He is one of my most promising students.

Professor Newberry visited the field of excavation very often throughout the season and let me profit from his long experience in archaeological work. He has also been kind enough to help me in the preparation of this Report.

The excavations were always open to the students of the Egyptological section of the Egyptian University and some of them came regularly to see the progress of the work, especially Pahor Effendi Labîb and Abd El-Salâm Effendi, who is now Curator of the University Museum.

Lastly I have to thank the Dean of the Faculty of Arts, Dr. Taha Hussein, for facilitating my work in every possible way.

SELIM HASSAN.

INTRODUCTORY NOTE

THE area excavated during the season 1929-1930 is shown on the General Plan, facing the title-page. It includes the whole of the great Tomb of the *Sem*-priest Re \bar{c} -wer (pp. 1-38), and seventeen Old Kingdom Mastabas lying to the east, west, and south of it. Eleven of these Mastabas were inscribed and were built for the following officials:

- (1) The Overseer of the Scribes of the Pyramid of Khufu, Akhet- \bar{h} etep (pp. 73-86).
- (2) The Steward, I \bar{y} (pp. 101-4).
- (3) The Overseer of the *Ka*-servants of the King's Mother, Imby (pp. 91-5).
- (4) The Steward and Overseer of the *Ka*-servants, Weser (pp. 95-7).
- (5) The Overseer of the *Ka*-servants, Fefi (pp. 97-101).
- (6) The Companion of Re \bar{c} -wer and Overseer of the Young Men of the Palace,¹ Mersu- \bar{c} ankh (pp. 104-17).
- (7) The Steward of the *Sem*-priest, Meruka (pp. 62-3).
- (8) The Overseer of the Department of the Domains of the Great House, Nefer-went (pp. 68-71).
- (9) The Instructor of the Royal Singers, Re \bar{c} -wer (pp. 66-8).
- (10) A man without titles named Zefa-nesut (pp. 63-5).
- (11) The Overseer of the *Ka*-servants, Deda (pp. 86-9).

Besides these Mastabas, over one hundred shafts were cleared and examined (pp. 39-61); they are all described in the present volume.

The area that has been explored is not all 'virgin' ground. 'Sondages' were made in it in the time of Mariette Pasha, but the exact date when they were carried out is not known, and no records are available, if any were ever made. Several Statues and fragments of Statues of Re \bar{c} -wer were brought to the Cairo Museum in the seventies of last century; these undoubtedly were found in Re \bar{c} -wer's Tomb. The inscriptions on one Statue were copied by the Vicomte Emmanuel de Rouge before 1876,² for they were published by his son, the Vicomte Jacques de Rouge in 1877, in Pl. VI of the ninth volume of *Études égyptologiques* entitled *Inscriptions hiéroglyphiques copiées en Égypte*, Paris, 1877. This Statue and others from the same source are described in Dr. Borchardt's volumes of the *Catalogue Général du Musée du Caire: Statuen und Statuetten von Königen und Privatleuten*, Tomes I and II, Berlin, 1911, 1925, under the numbers 198, 199, 200, 216, 217, 280 (?), 285 (?), 287, 318 (?), 350 (?), 365, 366, 367, and 815.

¹ Professor Junker would read 'the Overseer of the Young Men of the Estate of the Companion Re \bar{c} -wer'.

² The lithographed copy is signed 'Geslin, del. 1876'.

[This page is intentionally blank.]

CONTENTS

THE TOMB OF REḤ-WER

SPECIAL FEATURES	1
TITLES OF REḤ-WER	2
FAMILY	3
SITUATION	4
Forecourt	4
Main Entrance	4
The Offering Hall	9
The Eastern Passage or Corridor	13
The Open Court	21
MISCELLANEOUS INSCRIBED AND SCULPTURED SLABS FOUND IN THE TOMB OF REḤ-WER	32
FRAGMENTS OF STATUES AND STATUETTES FOUND IN THE TOMB OF REḤ-WER	36
BURIALS IN AND AROUND THE TOMB OF REḤ-WER	39

THE MASTABAS

MASTABA OF MERUKA	62
MASTABA OF ZEFA-NESUT	63
MASTABA OF REḤ-WER	66
MASTABA OF NEFER-WENT	68
MASTABA OF SHAFT NO. 35	71
MASTABA OF AKHET-HETEP	73
MASTABA OF THE OVERSEER OF THE <i>Ka</i> -SERVANTS, DEDA	86
THE UNINSCRIBED ROCK-CUT MASTABA	89
MASTABA OF IMBY	91
MASTABA OF WESER	95
MASTABA OF FEFI, CALLED PTAHSEZEFA	97
MASTABA OF Iḥ	101
MASTABA OF MERSU-CANKH	104

NOTES ON THE FLINT IMPLEMENTS found during the course of the Excavations. *By* P. PAUL

BOVIER-LAPIERRE, S.J.	117
-------------------------------	-----

[This page is intentionally blank.]

LIST OF PLATES

Site plan of the Excavations of the Cairo University

frontispiece

PLATE		
I.	Tomb of Rer-wer:	View of the Forecourt
II.	„	Fragments of the Lintel and Jambs
III.	„	Inscriptions on Jambs of Passage Doorway and Fragment of a Sculptured Scene
IV.	„	Sculptured Scene of Rer-wer and his Mother
V.	„	View of the Offering Chamber
VI.	„	Sculptured Slabs
VII.	„	Sculptured Slabs
VIII.	„	Triple Statuette as found and a Sculptured Slab
IX.	„	Triple Statuette of Rer-wer
X.	„	Fragments of an Alabaster Statuette
XI.	„	Fragments of Sculptured Scenes
XII.	„	Inscription on Pillar
XIII.	„	Statue of Rer-wer in Shrine
XIV.	„	Fragment of Jamb of Doorway to Court and Fragments of Seated Statues of Rer-wer
XV.	„	View of Stelae and Two Serdabs
XVI.	„	View of Central Court
XVII.	„	Fragment of Roofing and Sculptured Slab in Court
XVIII.	„	Biographical Inscription
XIX.	„	Statue in Naos
XX.	„	View of Serdab No. 13
XXI.	„	Limestone Statuette
XXII.	„	Triple Statuette in Limestone
XXIII.	„	Fragments of Statues
XXIV.	„	Profile of the Head of a Limestone Statue
XXV.	„	Views of Pillar and of the First Alabaster Altar in the Central Court
XXVI.	„	View of Brick Chamber and Niche with Alabaster Panel
XXVII.	„	Niche with Alabaster Panel <i>in situ</i>
XXVIII.	„	Alabaster Panel
XXIX.	„	Fragment of a Sculptured Scene
XXX.	„	Bases of Statues of Rer-wer and of Members of his Family
XXXI.	„	View of Rock-cut Chamber

PLATE		
XXXII.	Tomb of <i>Rer-wer</i> : The Second Alabaster Altar	
XXXIII.	„	Fragments of Sculptured Slabs
XXXIV.	„	Fragments of Sculptured Slabs
XXXV.	„	Shells and Pottery Vase from Shaft No. 16: Inscribed Limestone Slab
XXXVI.	„	Fragments of Inscribed blocks
XXXVII.	„	Fragments of Inscribed blocks
XXXVIII.	„	Heads of Statue and Statuettes
XXXIX.	„	Statuette and Fragments of Statues
XL.	„	Fragments of Limestone Statues and Statuettes
XLI.	„	Fragments of Limestone Statuettes
XLII.	Tomb of <i>Meru-Ka</i> : Necklace, Fragments of Sculptured Blocks and Canopic Jars	
XLIII.	Mastaba of <i>Zefa-nesut</i> . View	
XLIV.	False Doors of <i>Rer-wer</i> and of <i>Nefer-went</i> : Statuette of <i>Zefa-nesut</i>	
XLV.	Faience Beads from Tomb of <i>Nefer-went</i> and Ivory Castanets found in the Courtyard of the Rock-cut Tomb	
XLVI.	Fragments of Sculpture from the Mastaba of Shaft No. 35	
XLVII.	Tomb of <i>Akhet-hetep</i> : Sculptures on Jambs of Entrance Doorway	
XLVIII.	„	Sculptured Faces of Pillars in Chamber
XLIX.	„	Sculptured Faces of Pillars in Chamber
L.	„	False Door
LI.	„	False Doors
LII.	Tomb of <i>Deda</i> : View of Entrance	
LIII.	„	Sculptured Figure in Chamber by Doorway and False Door and Sculptured Figures on Inner Wall
LIV.	„	Sculptured Figures on Walls of Chamber
LV.	View of the Façade of the Rock-cut Tomb	
LVI.	Tomb of <i>Imby</i> : Entrance, Lintel, and False Door	
LVII.	„	Limestone Statuette
LVIII.	Tomb of <i>Weser</i> : View of Entrance	
LIX.	Tomb of <i>Fifi</i> : View of Entrance and fragments of a Statuette found in the Shaft and Sarcophagus Chamber	
LX.	„	The False Door
LXI.	„	The Sarcophagus Chamber with Sarcophagus
LXII.	„	View of Side of the Sarcophagus in the Sarcophagus Chamber
LXIII.	„	West Side of the Sarcophagus
LXIV.	„	East Side of the Sarcophagus
LXV.	„	North and South Ends of the Sarcophagus

LIST OF PLATES

xiii

PLATE

- LXVI. Tomb of Iÿ: The Fallen Architrave before the Entrance
- LXVII. Tomb of Mersu-rankh: Entrance Doorway
- LXVIII. „ Offering-tables on the Floor of the Chamber, an Offering-table, and False Door by Entrance
- LXIX. „ False Door at End of Left Wall of Chamber and Offering-tables
- LXX. „ Triple Statuette of Mersu-rankh
- LXXI. „ Statuette of the Breweress
- LXXII. „ Double Statuette of Mersu-rankh
- LXXIII. „ Statuettes of a Man and Woman
- LXXIV. „ Statuettes of Mersu-rankh and his Daughters
- LXXV. „ Statuettes of Mersu-rankh and his Wife
- LXXVI. „ Statuette of a Man
- LXXVII. Group of Statuettes as found in the Tomb of Mersu-rankh and Miscellaneous Objects from Shafts
- LXXVIII. Necklace found in Shaft No. 133
- LXXIX. Necklaces found in Shaft No. 133
- LXXX. Miscellaneous Pottery found during the Course of Excavating
- LXXXI. Flint Implements

[This page is intentionally blank.]

THE TOMB OF RE^c-WER

SPECIAL FEATURES

BEFORE beginning the description of the tomb it may be of interest to point out some of the special features which have been brought to light during its excavation.

1. It is one of the largest private tombs of the Old Kingdom that has been discovered in Egypt. It is not a Mastaba but consists of a series of irregular chambers unsymmetrically arranged. So complex is the plan that it gives one the impression that the tomb was enlarged from time to time during the course of its construction.

2. The number of its Serdabs and Niches is remarkable. Generally a tomb of Old Kingdom date has one or two, or at most five, Serdabs for statues or statuettes of the deceased. Here there are 25 Serdabs and 20 Niches. Many of these Serdabs contained more than one statue or statuette, and in one instance five. Usually a Serdab has but one opening by means of which the statue could be seen by a visitor to the tomb. Some of the Serdabs here have as many apertures as there were statues in it, and some have also special openings or 'windows' to let in light.

3. In Egyptian tombs the Serdab is generally hidden from the visitor, but here, in some cases, the four walls of the Serdab are exposed to view, and one is actually built in the façade of the tomb. Before the opening of the Serdab there is a step for the visitor to mount and inspect the statue within; this is believed to be a new feature in tomb design. In the brick Serdabs the aperture is a narrow opening extending from base to top of the wall.

4. From the number of Serdabs and Niches it may be inferred that there were once more than a hundred statues and statuettes of Re^c-wer contained in the tomb. This number is as unparalleled for a private person as it is for a monarch.



















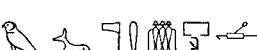

5. Some of the Statues were carved in one piece of stone with the naos, and another noteworthy fact is that two of the statuette groups are 'triple statuettes' of the same individual (pp. 13, 21).

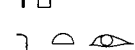
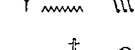
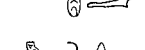
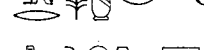
6. The two massive round Alabaster Offering Tables (pp. 21, 31) are unique of their kind, and so also is the Alabaster Panel (p. 24). The Offering Tables were embedded below in crude brick and the Alabaster Panel was framed and backed in crude brick, not in stone; this was probably because crude brick is less affected by heat than stone and would tend better to preserve the alabaster.



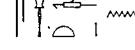

7. The two Libation Pits (pp. 26, 29) are unusual and were certainly employed in the Cult of the Dead.

8. All the blocks of stone in one part of the tomb were inscribed with the name of Re^c-wer written in linear script in red paint; these were doubtless made by scribes in the quarry from whence the stone was procured.

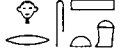
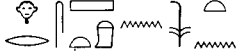

TITLES OF RE'-WER

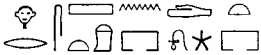
1.  Sem-priest.
2.  Ritualist.
3.  Chief Nekhbite.
4.  Priest of the goddess Nekhebt.
5.  Priest of the goddess Uto.
6.  Priest of the goddess Uto in the town Pe and Dep.
7.  *Khet*-priest of Min.
8.  Priest of Horus and Anubis President in the House of Service.
9.  Priest of Horus and Anubis Sole President in the House of Service.
10.  Overseer of the *Wcabt*-house.
11.  Director of the Kilt.¹
12.  Director of the Palace.
13.  Maker of the King's hair, i.e. 'hairdresser'.
14.  Attached to the 'Fair-is-the-face', i.e. the crown.
15.  Overseer of every royal ornament.
16.  Overseer of the King's Ornaments in the Two Houses.
17.  Overseer of the Two Chambers of the King's Ornaments.
18.  Sole Confidant, or Sole Companion.
19.  Sole beloved Confidant.
20.  He who is in the heart of his Master.
21.  The Unique One among the Great of the Feast.
22.  Director of the Mansions of Water.
23.  Domain-administrator of Buto.

¹ For a recent study of this title see Jéquier, *Tombeaux de particuliers contemporains de Pepi II*, p. 16.

24.  Domain-administrator of (the Vineyard called) 'Star of Horus, President of Heaven'.
25.  Master of the Secrets.
26.  Master of the Secrets of the King.
27.  Master of the Secrets of the Sacred Words, i.e. Scholar.
28.  Master of the Secrets of the Toilet House.
29.  (A title connected with shipbuilding.)

FAMILY

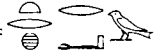
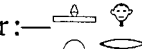
- Father:— ¹ The One Concerned with the King's Affairs, 'It-s.'¹
- Mother:— Hetepheres.
- Son:— The One Concerned with the King's Affairs, Re'-wer.
- Daughter:— Hetepheres.

¹ The reading of this name is uncertain.

SITUATION OF THE TOMB OF RE^c-WER

THE tomb of Re^c-wer lies directly to the south-west of the Sphinx, from which it is separated by the paved sloping Causeway leading from the so-called 'Temple of the Sphinx' to the Pyramid of King Chephren.

FORECOURT (Pl. I and Fig. 2)

The area of the FORECOURT, as it now exists, is about 12.80 metres by 17.87 metres, but it is not possible to decide its original extent as the eastern boundary is covered by part of the brick Girdle-wall of the Sphinx; this wall was erected by Tutmôsis IV, for bricks built into it are stamped with the prenomen of that king. On the west, the Forecourt is bounded by a small uninscribed Mastaba which may be older than Re^c-wer's tomb. On the north is the paved Causeway leading from the Temple of Chephren to the Pyramid of that monarch. In the floor of the Forecourt are thirteen shafts¹ of different depths which probably date from the end of the Old Kingdom. The Forecourt ends on the south side by a depression 16.70 ms. by 1.50 ms. Its depth on the west is 1.50 ms., but it gets shallower and narrower towards the east until it disappears under the enclosure wall of the Sphinx which is here vaulted below. At this point the depth is half a metre and the breadth 1.40 ms. The existence of this depression raises a difficult question: Where was the principal entrance to the tomb? The answer may be one of two hypotheses. There must have been either steps leading down to it, or the entrance was from the east side of the depression which is now hidden under the Girdle-wall of the Sphinx.

MAIN ENTRANCE

The MAIN ENTRANCE is not symmetrically situated in the centre of the Façade, for the western side is shorter than the eastern. On the eastern side there has been built a long SERDAB (S. 1)² measuring on its exterior 6.50 by 1.50 ms. and on its interior 5.25 by 9.60 ms.; its present height is 2.85 ms. The aperture of this Serdab is in the east wall.

On both sides of the Entrance were two columns whose bases, measuring 0.90 m. in diameter, are still *in situ*; they are of white Turah limestone. The columns have disappeared and the large architrave which they supported has fallen and is broken into several pieces; it measured 5.25 ms. by 0.68 m. by 1.03 ms. and was cut from the local rock. This architrave is inscribed with two horizontal lines of incised hieroglyphs painted in green; some of the hieroglyphs are much weathered. The text, which reads from right to left, is as follows:—

- (1)  Seated figure
of Re^c-wer.
- (2) 

'A boon which the king gives, and a boon (which) Anubis Presiding over the God's Dwelling gives; he having reached a very good old age that he be buried in the necropolis of the [western] desert the Sole Confidant, the Chief Nekhbite, the Domain-administrator of the (Vineyard called) "Horus, President of Heaven", the Priest of Horus and Anubis Sole President in the House of Service, Re^c-wer.'

¹ These shafts are numbered 1, 2, 16, 45, 46, 47, 48, 52, 53, 54, 157, 158, and 159; for descriptions of them see pp. 39-42.

² On the General Plan and elsewhere 'S' is used for an abbreviation of the word Serdab.

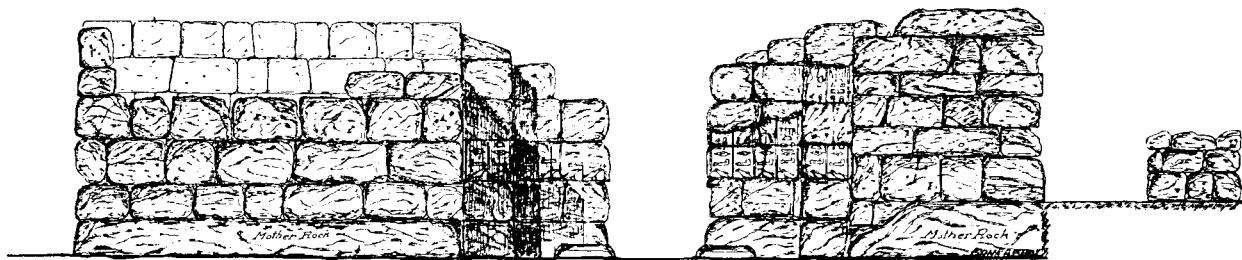

FIG. 1. The Façade of Main Entrance.

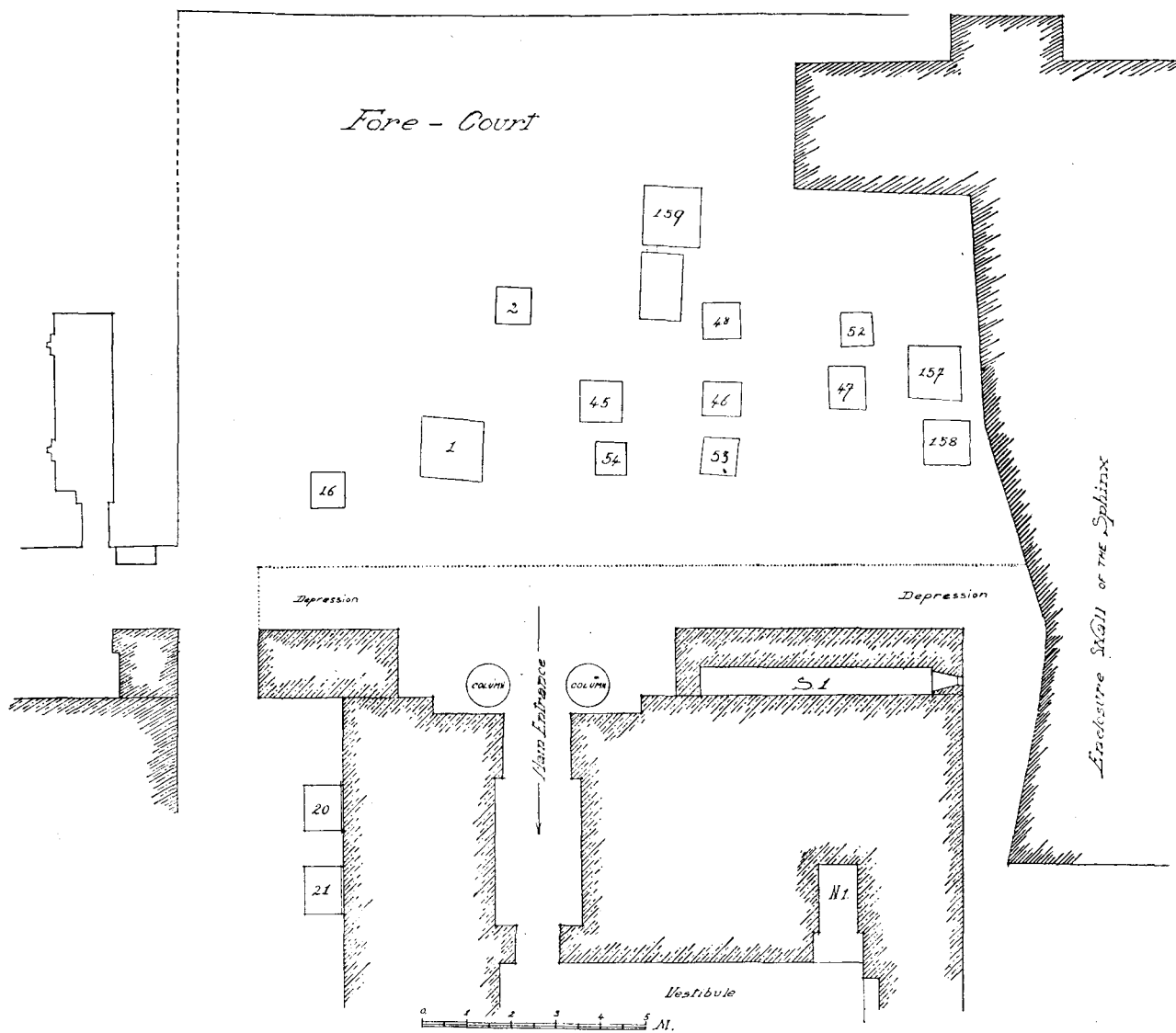
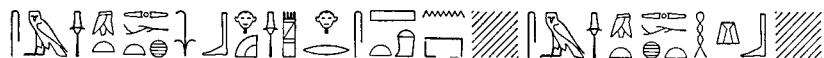

FIG. 2. Plan of the Forecourt.

Below the architrave was the lintel of the doorway; this, like the architrave that was above it, has fallen and is broken into several fragments (Pl. II, 1). It was inscribed with a horizontal line of hieroglyphs giving the name and titles¹ of Re \bar{c} -wer:—



On each side of the façade of the Main Entrance were eight vertical columns of large incised hieroglyphs coloured blue; on the left-hand side all except the ends of the lines, giving the name of Re \bar{c} -wer, are destroyed; those on the right-hand side read as follows²:—



Near the Main Entrance two pieces of polished diorite, measuring 30 cms. in height by 54 cms. wide, were found in the debris (fig. 3); they probably formed part of a pyramidion.

The walls of the façade are built of blocks of local stone and rest on the native rock which has been cut down to about 0.71 m. in one place and then descends gradually. The opening of the doorway is 1.58 ms.; the thickness of the jambs 20 cms.; and the present height 3.26 ms. On each jamb was a vertical line of hieroglyphs, but only the name of Re \bar{c} -wer and a single title (𓂏𓂏𓂏𓂏) remain.

The doorway gives access to a passage (3.32 ms. by 1.94 ms.), the walls of which are built of

¹ For translations of these titles see pp. 2, 3.

² For the translations of these titles see pp. 2, 3. Two fragments are figured in Pl. II, 2 and 4, but they have been photographed to a different scale.

coarse yellow local stone. This passage leads to another doorway with jambs of Turah limestone (85 cms.). On each jamb were two vertical columns of hieroglyphs, but only fragments of one line on each side still exist (Pl. III, 1 and 2). The hieroglyphs were incised and painted blue; those preserved read:—

Left jamb ←↓ [Hieroglyphs]

Right jamb ↓→ [Hieroglyphs]

The last-mentioned doorway gives access to a rectangular VESTIBULE measuring 8·20 ms. long by 2·22 ms. broad. The floor is paved with slabs of Turah limestone. The northern wall was

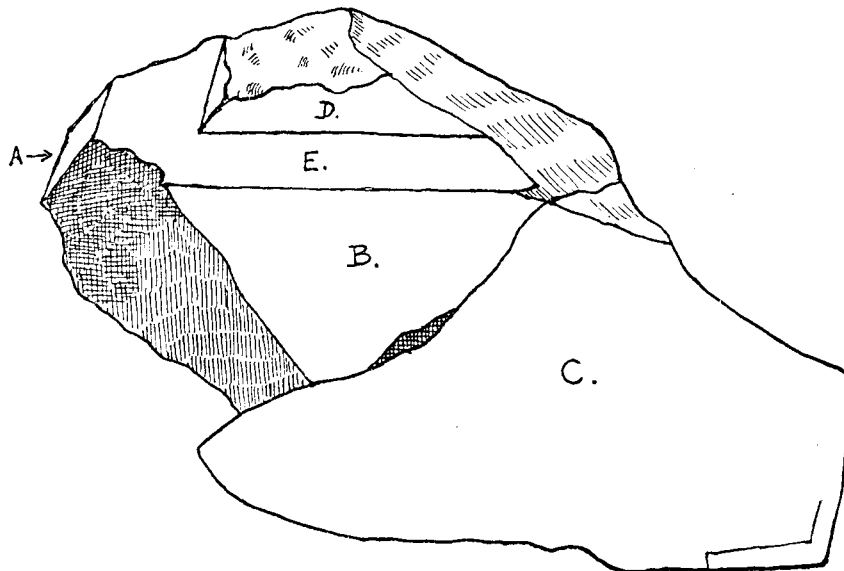

A-C. POLISHED SURFACES. D, E. SMOOTHED SURFACES.

FIG. 3. Fragments of a Diorite Pyramidion.

cased with white limestone and was sculptured with scenes of daily life, but all that remains of these scenes is shown on Pl. III, 3. Here are represented men gathering flax and loading it upon asses. At the eastern end of this wall is a NICHE (N. 1)¹ which probably contained a statue, for in it was found a fragment of a hand of a limestone statue (Pl. XLI, 17).

The southern wall is built of three courses of local stone, the upper courses being Turah limestone; in it is the aperture to SERDAB 2 (see fig. 4). Only a closed hand with parts of an arm and wig of a life-sized statue were found in it (Pl. XL, 3, and Pl. XLI, 16). The white limestone courses of this southern wall of the Vestibule were sculptured with scenes in relief, but scarcely a trace of these now remain.

The eastern wall is built of Turah limestone with a finely sculptured scene in low relief of Re^c-wer seated, with his mother standing in front of him (Pl. IV, and fig. 5). Re^c-wer wears a short wig, and a necklace coloured pink, and is clad in a panther's skin; in his left hand he holds a long staff and in his right a handkerchief. His mother stands before him with her right hand raised to her breast: she wears a long wig, two necklaces, bracelets, and anklets, and is clad in a long close-fitting transparent white garment. Above the portrait of Re^c-wer are his titles and

¹ On the General Plan and elsewhere N. is used as an abbreviation of the word 'Niche'.

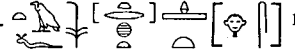
name. Above the figure of his mother is the inscription:—  'His Mother, the One Concerned with the King's Affairs, Hetep-heres'.¹

On the thickness of the right-hand framing of this scene are the figures of two women in low relief; they face one another and between them is the name of one  Khentkaues. On the

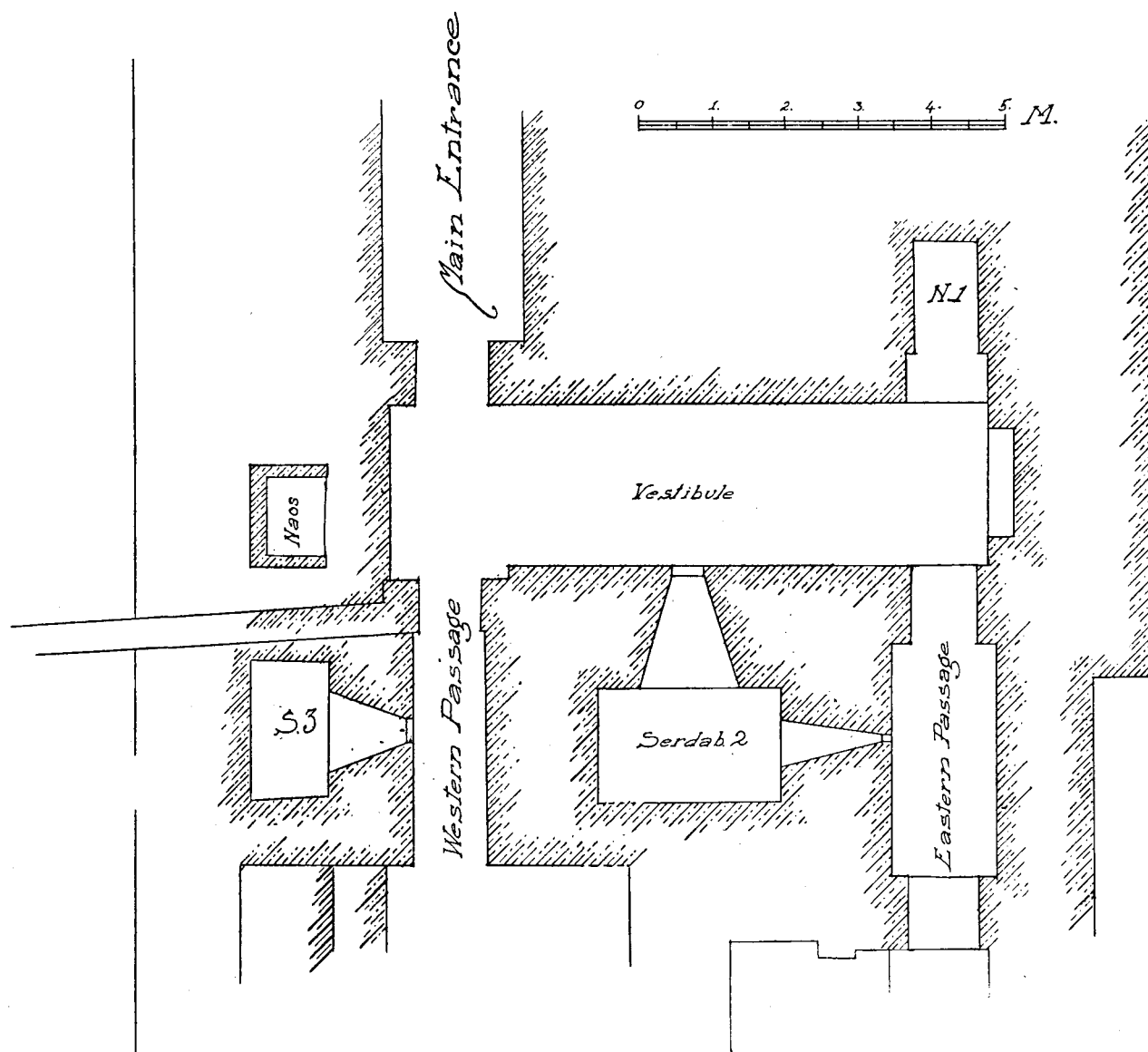

FIG. 4. Plan of Vestibule.

right-hand frame itself are sculptured two men facing northwards, i.e. in the direction of *Rei-wer* in the principal scene.

In the western wall of the Vestibule there is a simple Naos of one piece of white limestone placed about 1.70 ms. above the level of the paved floor. The interior dimensions of the base of this Naos are 1.04 ms. by 82 cms. Its present height is 1.80 ms. From its position, as well as from its being without inscription, it may possibly be of a later date than *Rei-wer*.

¹ For this name see p. 29.

THE OFFERING HALL

At the right-hand end of the southern wall of the Vestibule there is a doorway and passage leading to the OFFERING HALL (Pl. V and fig. 6). The jambs of the doorway are of white lime-

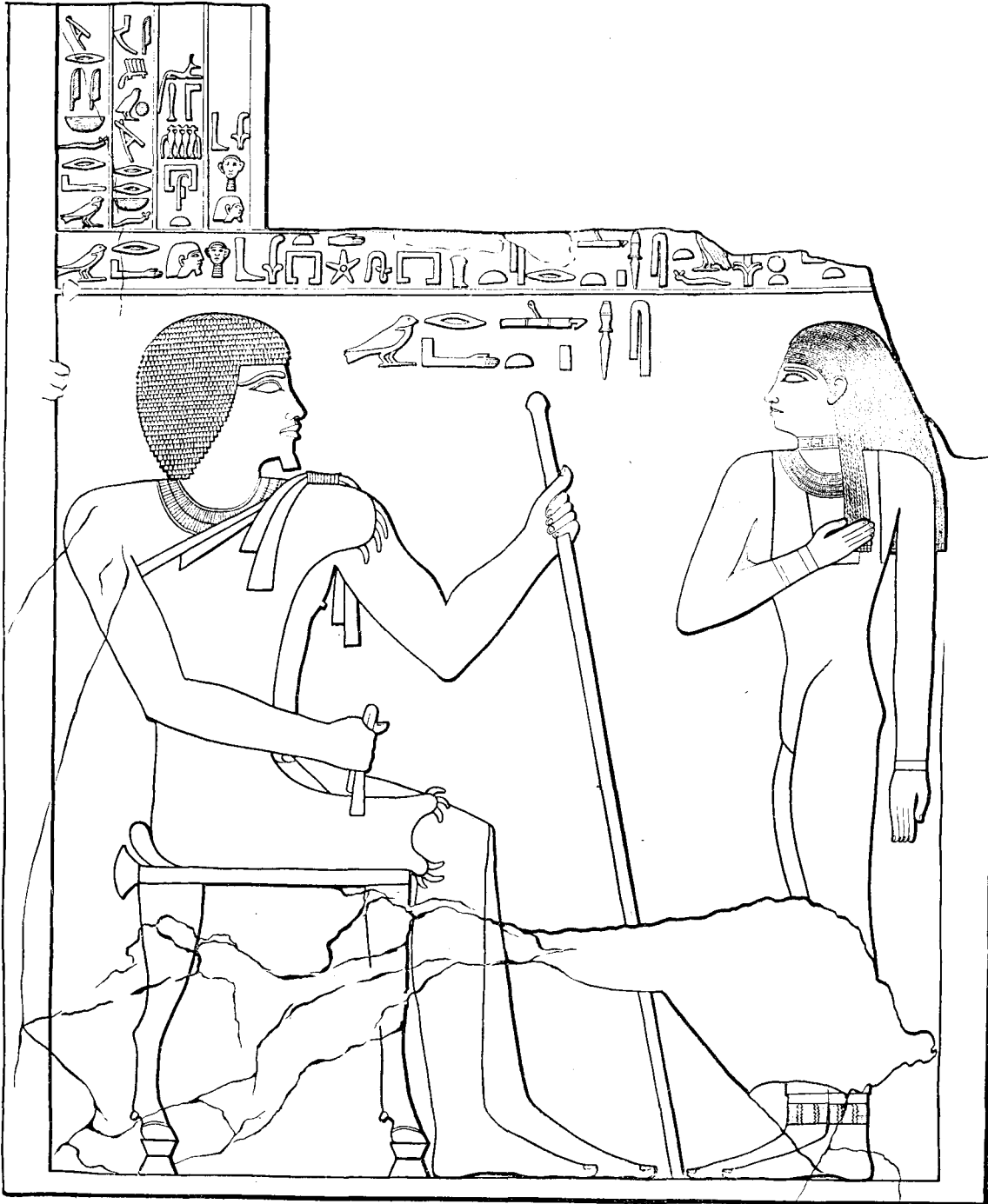
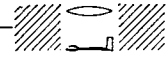

FIG. 5. Re^c-wer and his mother.

stone; the present height of the one on the western side is 2.65 ms., and of that on the eastern side is 2.30 ms. On the thickness of each jamb there was a vertical line of hieroglyphs carved in relief. The eastern side is entirely defaced and the western one has only three

signs preserved:—. The thickness of each jamb is 75 cms. The upper part of the western one was sculptured with scenes and inscriptions in relief, but these are now too much weathered to be decipherable.

The Passage measures 3.15 cms. by 1.01 ms. In its western wall is the SERDAB NO. 3 with

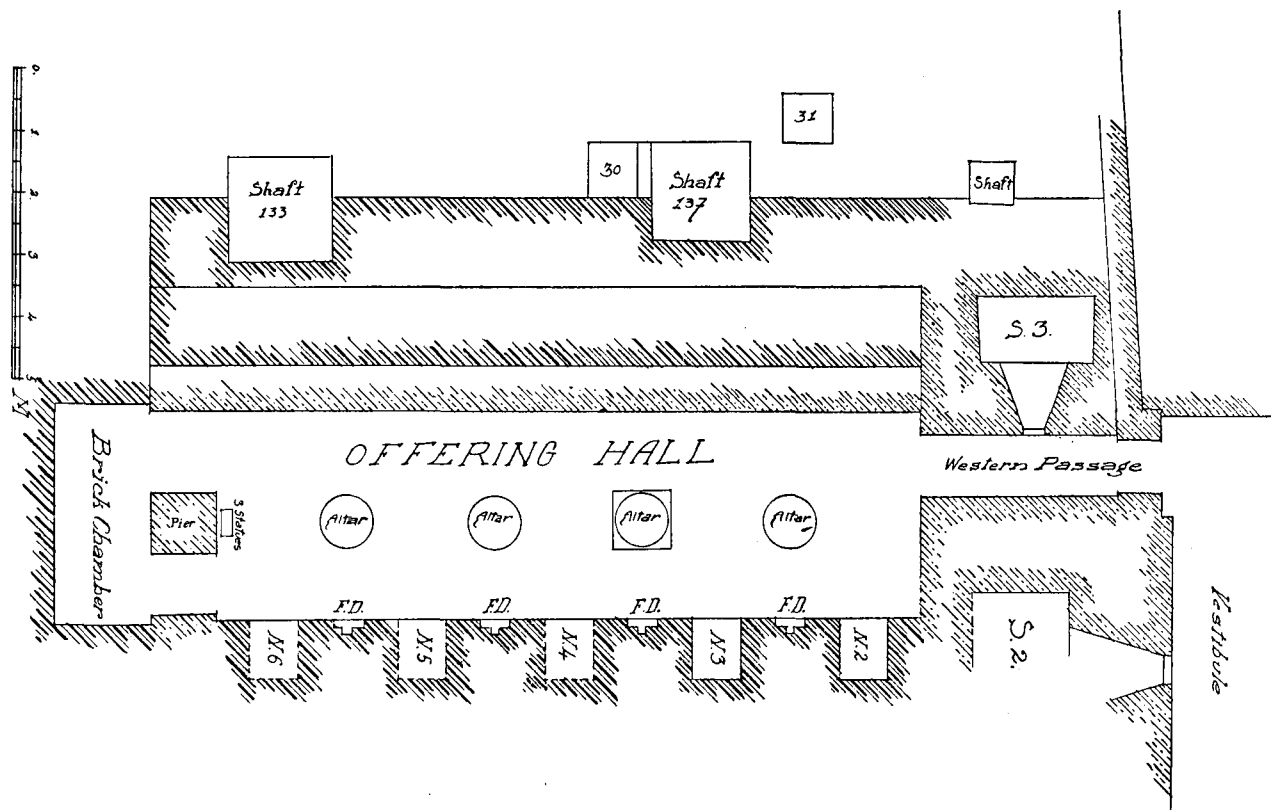

FIG. 6. Plan of Offering Hall.

its aperture in the centre of the wall at a height of 1.55 ms. Fragments of a small black granite statuette were found in it.

The Offering Hall is rectangular and measures 11.47 ms. in length by 3.40 ms. in breadth. Its eastern wall is built of crude brick and down the axis of the Hall are four large circular offering tables (or the bases of offering tables) of white limestone. Each measures 86 cms. in diameter, and they are equidistant from one another (about 1.55 ms.). In the eastern wall opposite each offering table is a false door, and between each false door is a recess or Niche for a statuette; these niches are 80 cms. in width and 1 m. in depth. Of the last two niches (N. 5 and N. 6) only traces now remain. All the niches and false doors are covered with plaster and were painted red. The statuettes in the niches were probably all of alabaster; in front of the second Niche (N. 3) was found the torso of an alabaster statuette of *Reu-wer* (Pl. X); the head of this statuette was discovered during the season 1930-31 among the filling of Shaft No. 130.

The western wall of the Offering Hall was built on a raised platform of crude brick, 30 cms. high; it is of white limestone and was sculptured in relief with scenes of men and women bearing offerings. Of these scenes only six fragments have been preserved (Pls. VI and VII).

Fragments A and B of Pl. VI fit together but have been photographed on a different scale. On them are sculptured in low relief two rows of female offering-bearers, one above the other. The height of the two registers is 84 cms. and the thickness of the slabs is 22 cms. The first three figures in the upper register bear baskets upon their heads full of provisions; the fourth carries a rectangular box upon her head. The third figure holds in her left hand a small vase. In the lower register are five female offering-bearers; these figures are only wanting their feet, otherwise they are in perfect preservation. They all bear offerings upon their heads. The first and third carry small vases in their left hands; the second carries ears of wheat in her right hand, and the fifth a lotus flower in her left hand. Before each figure is the name of the village of Re^c-wer's estate from whence the offerings had been brought. Two of these place-names are compounded with the name of Chephren, and one with that of Shepseskaef. The names are:—

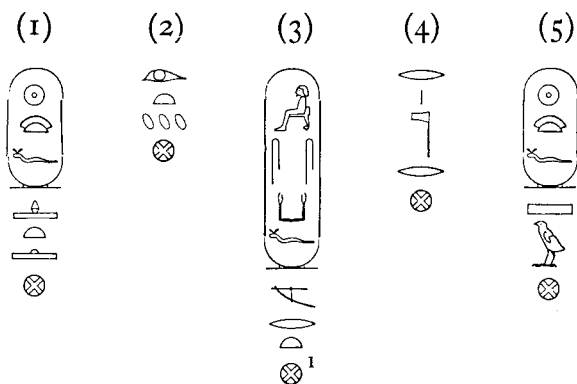

Behind the fifth figure was a sixth, but the name of the estate that it represents cannot now be deciphered; it was, however, a place-name compounded with the name of a king.

Fragment C. See fig. 7. Two registers. Of the upper register only the feet of a seated figure of Re^c-wer and the lower corner of a table for offerings remain. In the second register are the upper parts of two figures—a man and a woman—and the right arm of another are preserved. Both figures bear offerings in baskets upon their heads. The inscription in front of the first is lost; that in front of the second reads ; and that in front of the third gives the name of an estate village compounded with the name of Chephren: .

Fragment D. See Pl. VIII, 2. Two registers. The upper one of three female offering-bearers sculptured in low relief, but only the lower parts of the figures are preserved. In the lower register there are also figures of three offering-bearers, but here the lower parts of the figures are broken away. Before the second and third were the names of estate villages, both names being compounded with king's names:—(1) , (2) . To the left of the two registers was a vertical line of hieroglyphs, the middle part of which is alone preserved. It reads .

Fragment E. See Pl. VII, 1. From the uppermost register of the wall. Three male offering-bearers facing to the right carrying birds and other offerings. Only the back part of the first figure is preserved and the lower part of the legs of the other two are broken away.

¹ This place-name appears again on a limestone fragment, p. 36.

Fragment F. See Pl. VII, 2. A single female offering-bearer sculptured in low relief, facing to the left, brings a *mishanna* full of fruits upon her head; in her left hand is a small bag. Before her is the name of the estate which she represents: . On the



FIG. 7. Offering-bearers.

left-hand bottom corner of this fragment is the name of *Ree-wer* in large hieroglyphs sculptured in relief.

At the southern end of the Offering Hall, in a line with the bases of the offering tables, was a pier of rectangular section, 1.06 ms. by 0.96 m. To the right and left of it are doorways of equal breadth (1.30 ms. by 98 cms.) that lead to a brick-built chamber measuring 3.56 ms. by 1.60 ms. That on the western side had a door with two leaves, the sockets for which are still visible. Against the southern wall of the pier were found three figures carved in one piece of quartzite

and all representing ReḲ-wer standing. (For the figures in position see Pl. VIII, 1, and for the figures themselves, Pl. IX).

The pedestal of this group is 42 cms. by 20 cms. The height of the central figure is 64 cms., those on either side are 62 cms. The three are equal in breadth of chest (14 cms.). The head-dress of the middle one is different from the other two, which makes the difference of 2 cms. in its height; otherwise the figures are similar in every respect. The hands of each are closed holding the \square -object. The wigs are painted black, the bodies and inscriptions red. There are two horizontal lines of incised hieroglyphs, one near the right leg ($\leftarrow\downarrow$) and the other near the left leg ($\downarrow\rightarrow$) of the central figure. These two inscriptions are similar and read

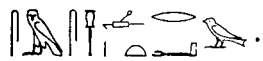

Under the western side of the pier were found two very sharp flint knives (see fig. 8), and in the brick chamber some finely carved fragments of an alabaster panel were discovered. On the pieces found the shoulder and arm and hand of a man can be seen (fig. 9). This alabaster panel was probably similar to the one described on p. 24.

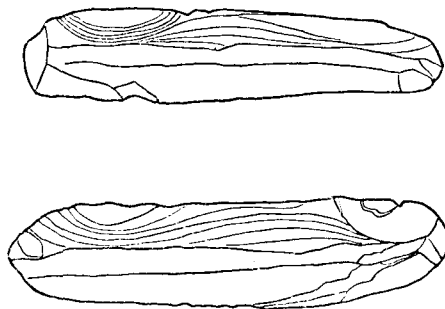

FIG. 8. Flint Knives found in Brick Chamber behind the Offering Hall.

THE EASTERN PASSAGE OR CORRIDOR

The jambs of the entrance to the EASTERN PASSAGE OR CORRIDOR are of white limestone, and on the thickness of the western one was a scene carved in low relief representing ReḲ-wer and a woman, probably his wife, behind him, standing and facing north (see Pl. XI, 1). Only the lower parts of these figures, from the waist downwards, are preserved. ReḲ-wer wears a long skirt pointed in front and carries in the right hand a cloth or handkerchief; he does not wear sandals. The woman behind him is clad in a long close-fitting white garment and has anklets on her legs; she also has bare feet. On the inner side of the jambs was a vertical line of hieroglyphs in relief, but only the name of ReḲ-wer remains on the western jamb. The scenes and inscriptions on the eastern jamb are entirely defaced.

From the inner side of the threshold of the entrance the Eastern Passage begins to slope. It measures 3.22 ms. by 1.44 ms. and the height is now 3 ms. In the western wall is an aperture to Serdab No. 2. This aperture is intact and is made at a height of 1.74 ms. from the floor. On the eastern wall, which is built of coarse yellow local stone, ReḲ-wer was figured seated on a chair with another person beside him, looking southward. Before them is a row of offering-bearers and a group of three men sacrificing a bull. Of this scene only faint traces are visible.

At the end of this first passage is a doorway leading to another and longer corridor sloping downwards in the same direction as the first. The door here was of one leaf turning on a pivot on the left side. A projecting design, perhaps representing a Key,¹ behind the door must have been made to fit into a special recess in the leaf of the door. The jambs are of white limestone except a single slab in the third course of the western one which is of local stone. This second

¹ Compare Jéquier, *La Pyramide d'Oudjebten*, p. 9.

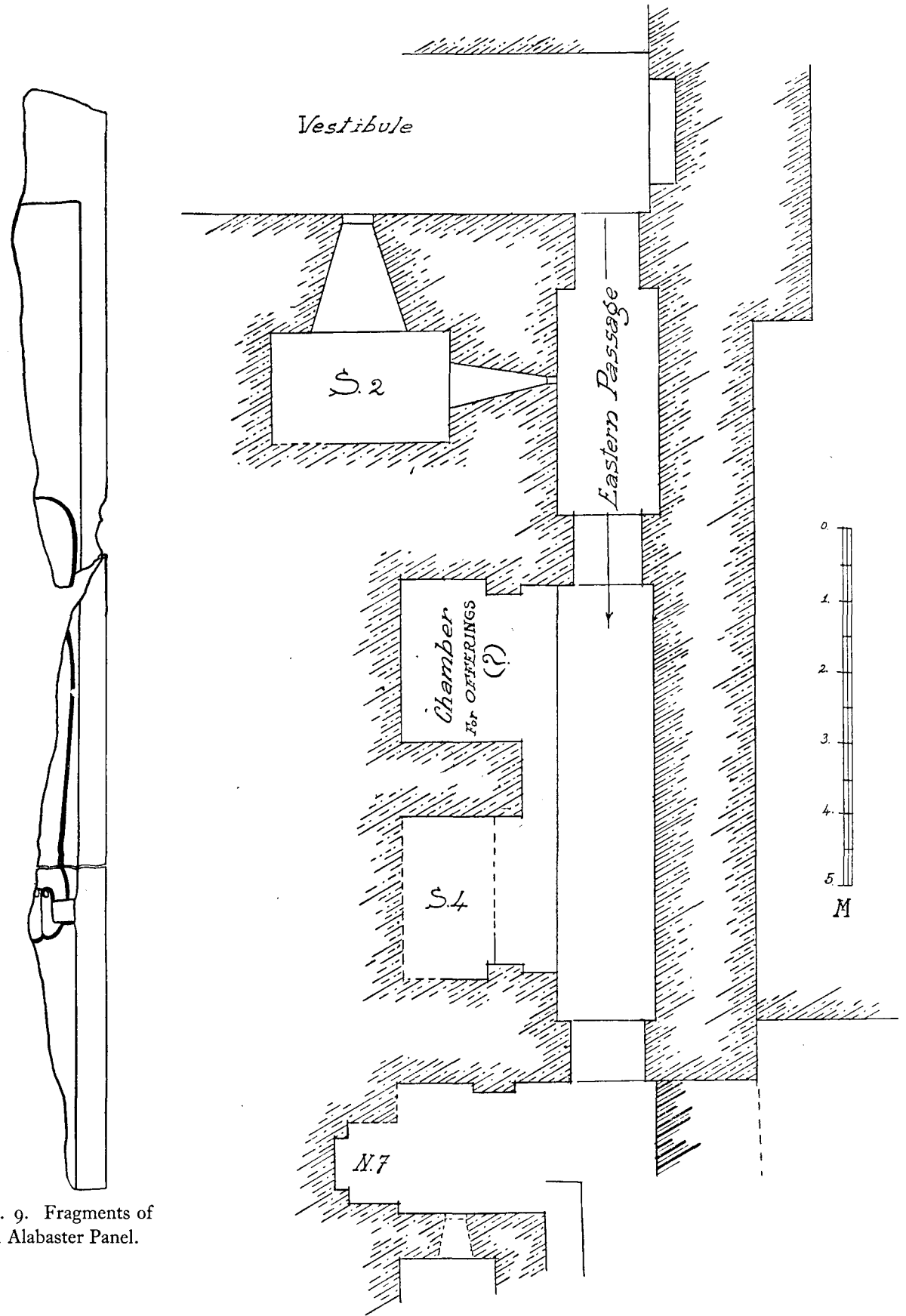

FIG. 9. Fragments of an Alabaster Panel.

FIG. 10. Plan of the Eastern Passage or Corridor.

sloping passage is paved and measures 6.15 ms. by 1.38 ms. The eastern wall is the external wall of the tomb and has a thickness of 0.85 cm.; it is now only 2.70 ms. high. On the western side there is a platform (width 45 cms.) with two chambers separated by a wall, on the outer face of which is inscribed a biographical inscription.

First Chamber. The first chamber, measuring 2.30 ms. by 1.22 ms. with present height 2.70 ms., was perhaps used for offerings, for there was found lying inside it a large white limestone slab that had fallen from its outer (?) wall which is sculptured with scenes of offerings carved in relief and painted (Pl. XI, 2). This slab is obviously from the top of a wall and served as part of the framing of a doorway or entrance to a recess. On the right-hand side of it is sculptured in relief the capital of a slender lotus-flower column and beyond this are two vertical lines of hieroglyphs giving titles of Re'-wer and reading ←↓:—



The Biographical Inscription on the outer face of the wall (1.02 ms. in breadth) separating this chamber from the next one on the south, is in a very ruinous condition and only some of the lower parts of its nine vertical lines of hieroglyphs are preserved. It reads ←↓:—

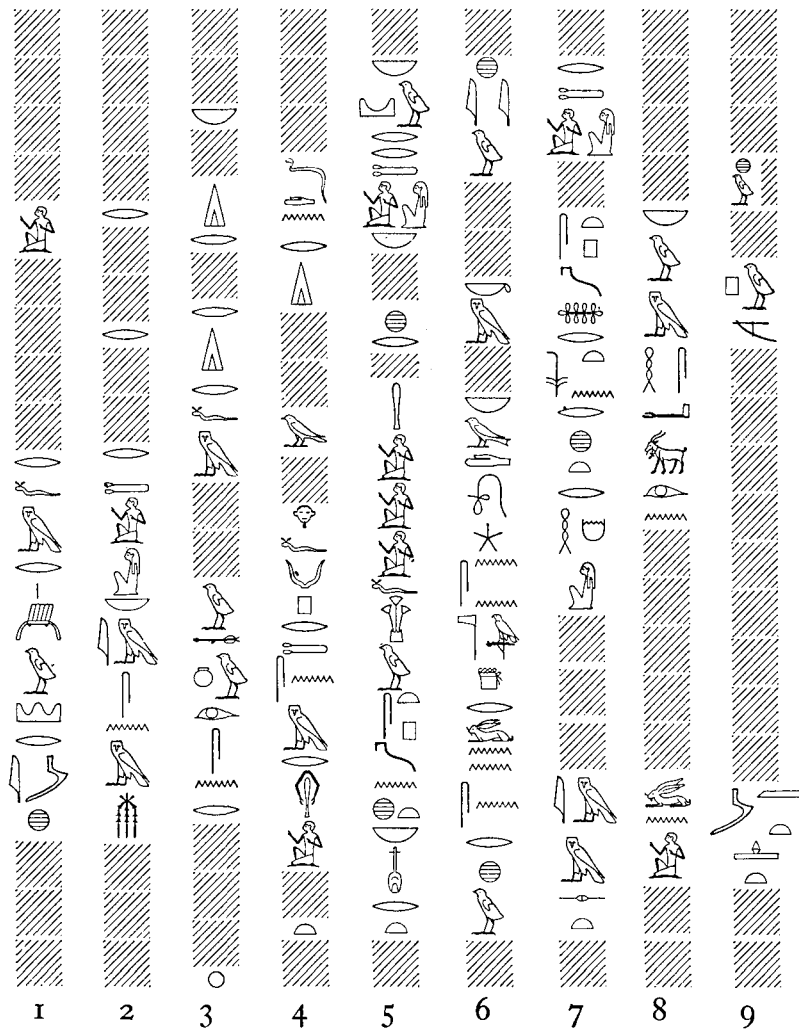

Biographical Inscription No. 1 (see Pl. XII).

Second Chamber. The Second Chamber of the Eastern Passage must have been a Serdab (S. 4), but the outer wall of it has been destroyed. It measures 2.30 ms. by 1.22 ms.

At the end of this part of the Eastern Passage a doorway leads to a third sloping passage longer than the first two (see fig. 11). It is 21.70 ms. long by 1 m. wide. Its eastern wall is built of sun-dried bricks faced with a layer of yellow plaster. Its original height is not certain; it is now only 1.55 ms. In thickness it is 1.56 ms. Immediately after the entrance on the west side is a small chamber or Niche (N. 7), at the back of which is a life-size statue of Re \bar{c} -wer in a naos (see Pl. XIII). The statue and naos are carved out of one piece of white limestone. The height

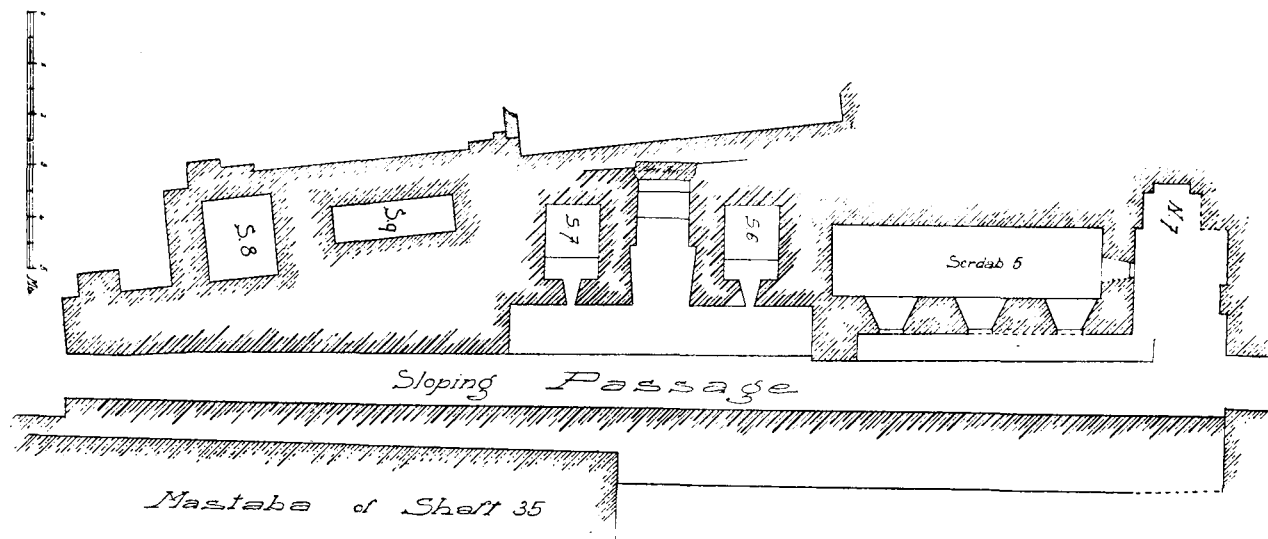

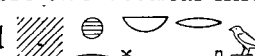
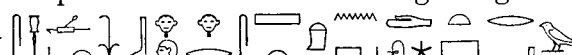
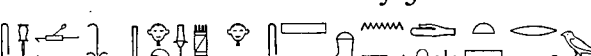

FIG. 11. Plan of Sloping Passage.

of the statue itself is 1.85 ms. Re \bar{c} -wer is here clad in a priest's robe and his hands hold the □-object: his head and feet are badly damaged. On the right rim of his robe is an inscription giving his name and titles:— . On either side of the frame of the naos were two vertical lines of inscription, the lower parts of which are alone preserved; they both read .

Next to the Niche No. 7 is a long Serdab (S. 5) measuring 5.27 ms. by 1.37 ms. It has four apertures; one opens at the north end of it, the other three are on the east side and are equidistant. The half of a life-sized Seated Statue in limestone (Pl. XIV, 2) was found with its front towards the first eastern aperture. Parallel to the right leg on the chair is a vertical line of hieroglyphs reading:— .

A fragment of a chair of another Seated Statue was also found in this Serdab (Pl. XIV, 3). It is of white limestone and measures 60 cms. by 50 cms. On it is incised a vertical line of hieroglyphs reading:— .

There is a platform measuring 5.35 ms. by 0.50 m. in front of the Serdab for the visitor to mount on and view the statues within. The outer casing is of white Turah limestone.

Beyond Serdab No. 5 are two more (S. 6 and 7) built of crude brick and each measuring 1.7 ms. by 1.45 ms. They are separated from one another by a paved passage that leads to a False-door or Stela placed above two steps. Instead of the usual Serdab aperture there is here a long

and narrow vertical opening 10 cms. in width. In each of these two Serdabs is an elevated platform, 1.03 ms. by 1.07 ms., on which the Statues were placed. As in the case of Serdab No. 5 there is a raised platform along the front of the two Serdabs; this measures 6 ms. by 0.94 m. The False-door or Stela between them may be a False-door for the great Central Serdab No. 12 which is directly behind it (see below p. 18). It may be remarked that there is a large sign cut in the middle of this False-door which resembles the sign  (Pl. XV).

Leaving Serdabs 6 and 7 and following the sloping passage for 8.50 ms., there is a doorway

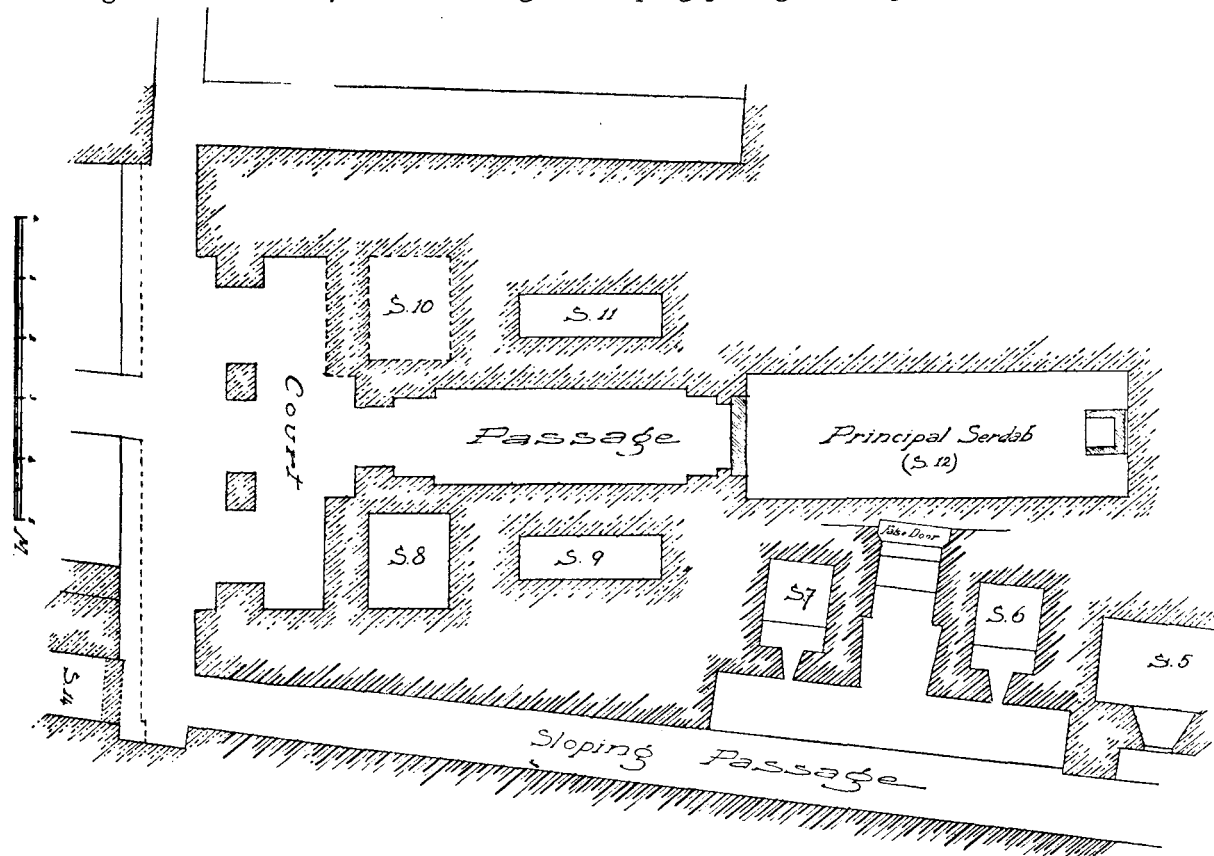

FIG. 12. Plan of the Central Court with Buildings behind it.

leading into the eastern side of the Central Court (see fig. 12 and Pl. XVI). On the left-hand jamb of this doorway were two vertical columns of hieroglyphs in relief, but only the name of Re'-wer is here preserved (Pl. XIV, 1). The northern end of the Central Court, measuring 5.90 ms. by 2.20 ms., was roofed, the roof being supported by two rectangular pillars 50 cms. by 60 cms. A fallen block shows that the roof was of limestone slabs carved to represent palm-trunk beams (Pl. XVII, 1). The walls, also of limestone, were probably sculptured with scenes in relief and painted. At the north end of the Central Court is a Passage, 4.30 ms. by 1.53 ms.; on each side of it were two Serdabs (S. 8 and S. 9 on the eastern side, and S. 10 and S. 11 on the western side). No statues were found in these Serdabs but fragments of two of limestone were brought to light from the Passage.

At the northern end of the Passage is a doorway which had a door in one leaf; the socket is still visible. On the jambs are the ends of two vertical columns of hieroglyphs reading:

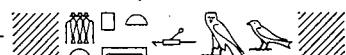

Serdab No. 12 and Biographical Inscription

Behind the door is the PRINCIPAL SERDAB (S. 12), which measures 6.35 ms. by 2.08 ms. On the lower courses of the southern wall (*i.e.* immediately behind the Passage doorway) are two figures of *Re-r-wer* in low relief facing one another (Pl. XVII, 2). Behind each figure was a vertical column of hieroglyphs giving the name and titles of *Re-r-wer*; of these inscriptions only a few signs are preserved behind the right-hand figure:— .¹

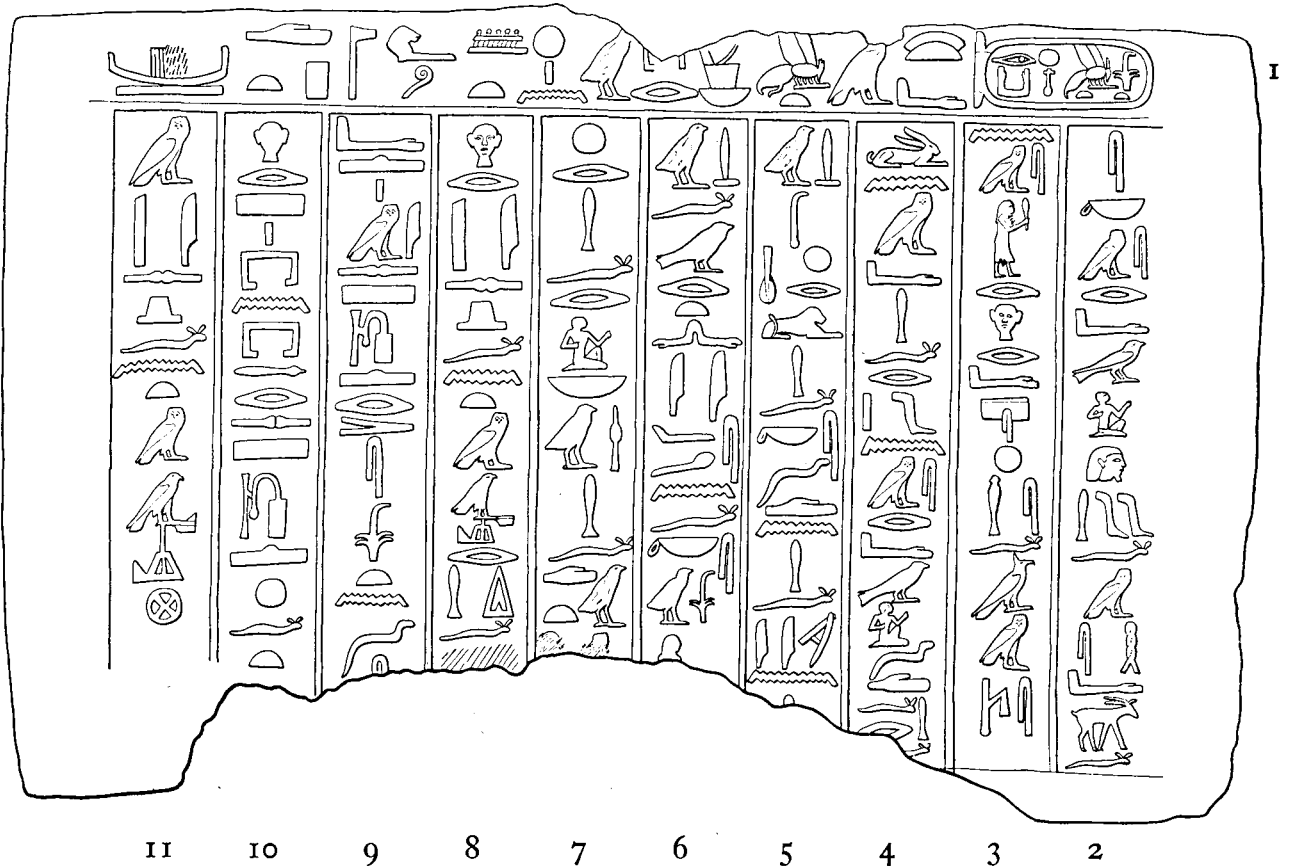



FIG. 13. The Biographical Inscription.

Inside the Serdab, at the back of its southern wall, was found a rectangular Stela measuring 57 cms. high, 1.25 ms. wide, and 25 cms. thick. It is of hard limestone, and its inscription consists of one horizontal line and ten vertical columns of hieroglyphs sculptured in relief (Pl. XVIII and fig. 13). It is probable that the original position of this important slab was at the top of the southern wall of the Serdab facing the doorway of the passage leading to it. Here was also the Serdab aperture.

The following is a free translation of the text:—(1) 'The King of Upper and Lower Egypt, Neferirkerec, appearing as king of Lower Egypt, on the day of drawing the hawser of the Divine Boat, (2) when the Sem-priest *Re-r-wer* followed the steps of His Majesty in his dignity (3) of Sem-priest,² The *ams*-staff (4) which was in the hand of His Majesty struck

¹ For the restoration of these titles see pp. 2 and 3.

²  is probably the same garment as the  which is often named in Old Kingdom inscriptions.

against the leg of the Sem-priest Reḫ-wer. His Majesty said (5) "Thou art well!" so said His Majesty. Then His Majesty said: "He is beloved of me"; (6) he is very well, no beating has been done to him. Behold he is more honoured¹ by (7) His Majesty than any man.² His Majesty ordered (this record) to be put (in writing) on (8) his tomb which is in the necropolis. His Majesty caused that there be made (9) a writing of it. It was written (accordingly) in the presence of the king himself (by) (10) the Overseer of the Garden of the Great House and it was written in front of him (11) in his tomb which is in the necropolis.'

Against the northern wall of this Serdab is a life-sized Statue of Reḫ-wer in limestone painted red (Pl. XIX); it measures 1.75 ms. high, and the width across the chest is 60 cms. It stands within a naos measuring 2.35 ms. by 85 cms. Both Statue and Naos are carved out of a single block of limestone. Reḫ-wer is represented standing with left leg forward; his arms hang down the sides of the figure, the hands grasping the □-object. Around his neck was a broad necklace with a pendant amulet. The only garment he wears is a loin-cloth which is crimped at one end. The head and greater part of the figure above the breast have flaked away, as well as the upper part of the Naos. The carving of the statue shows considerable anatomical knowledge on the part of the sculptor. On the front of the two sides of the Naos are vertical columns of hieroglyphs in low relief giving the name and titles of Reḫ-wer. The inscriptions on the two sides are identical but read ←↓ and ↓→.



On the floor of the Naos by the feet of Reḫ-wer are four vertical rows of hieroglyphs giving his name and titles:



The roof of the Serdab consisted of four large slabs of limestone but only one remains in place.



Serdab No. 13

Turning back to the Central Court and proceeding westwards, one passes through a long narrow pathway (14.73 ms. long by 92 cms. wide) whose northern side is bounded by three small Mastabas, the first of which belonged to Neferwent (see p. 68) and the last to Mersu-rankh (see p. 104). Its southern wall is the native rock, cut so as to represent built-up courses of stonework. At the end of this pathway is Serdab No. 13, erected on a platform elevated 85 cms. above the floor of the path. This Serdab forms the most westerly part of the tomb of Reḫ-wer, and it is interesting to note that in the northern, eastern, and southern extremities of the tomb other Serdabs were placed (see General Plan, S. 1, S. 14, and S. 23).

The walls of Serdab No. 13 have fallen, except a block on the right-hand side of the outer one (Pl. XX). This block appears to have formed part of the right-hand jamb of a doorway to the

¹ Read .

² For similar expressions see Sethe, *Urkunden*, I, p. 51, line 14 'more honoured before the king than any child'; line 17 'more honoured before the king than any youth'.

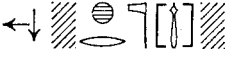
Serdab; on it is the lower part of a vertical column of incised hieroglyphs giving the name and titles of Re^c-wer:— . Two pieces of inscribed blocks were found near it; one bears the inscription, ; the other has the hieroglyphs  inscribed upon it. Inside the Serdab was found in its original position the lower half of a Statue (Pl. XXIII, 3).

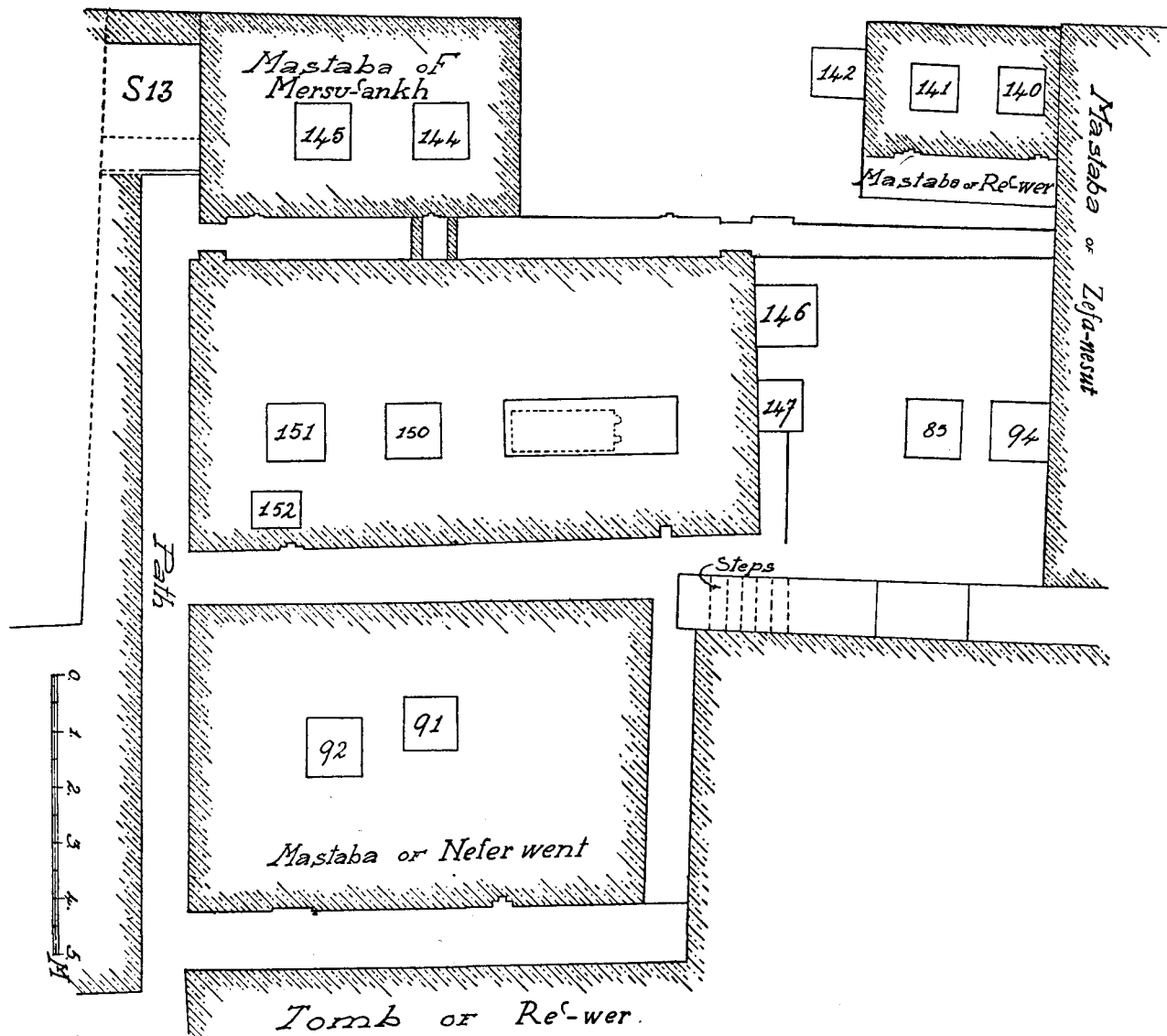

FIG. 14. Plan of the Serdab No. 13 and of the Mastabas near it.

In Shaft No. 91 was found the head of a white limestone Statue, and in Shaft No. 151 were a limestone Statue in two pieces (Pl. XXI) together with a Triple Statuette (Pl. XXII), also of white limestone, the pedestal of which had been broken off; this was later discovered in Shaft No. 145 adjacent to S. 13.



STATUETTE OF A MAN. Pl. XXI. Limestone, painted. Height 55 cms. Breadth, 15 cms. This male figure is represented standing with left leg thrust forward and arms hanging at his sides,

the hands grasping the ☐. He wears a short lined wig, necklace of bands of black, white, and green, and a white loin-cloth projecting in front. The skin is painted a deep red. Beneath the feet is a short pedestal and at the back of the figure a plinth. No inscription.

TRIPLE STATUETTE OF A MAN. Pl. XXII. Limestone, painted. Height, 62 cms. Breadth of pedestal, 50 cms. Three male figures standing side by side; the central figure and the one on its left have both arms hanging at the sides, the hands grasping the ☐. The right-hand figure has its right arm hanging at the side, the hand grasping the ☐; the left arm is placed round the back of the central figure, the hand showing below its left breast. Each figure is similarly clad. Wigs, short and lined, black. Faces and skin of body, arms, and legs, deep red; eyes, black with white spot in middle; eyebrows and lashes, black. Necklaces, bands of blue and green, that of the middle figure differing from the other two. Each figure wears a white loin-cloth crimped at one side, and one end of the white girdle projects upwards. No inscription.

THE OPEN COURT

Turning back towards the east, a sloping platform, 4.55 ms. long, leads from the centre of the Central Court into a spacious Open Court (see Plan, fig. 15); its western side is bound by the native rock cut to represent built-up courses of stone-work; on its eastern side is the outer face of Serdab No. 14. Lying near the western wall of the Open Court were found many fragments of a large limestone block with a scene sculptured in relief of Reḫ-wer sitting on a chair, clad in a panther's skin and loin-cloth and holding in his left hand a long staff. In front of Reḫ-wer were two vertical columns of hieroglyphs giving his name and titles, reading

←↓ (1) 
 (2) .

On the opposite side of the Open Court were found nearly a hundred fragments of another sculptured scene in relief representing Reḫ-wer standing with left leg forward, clad in a loin-cloth pointed in front, and holding in his left hand a long staff. Before this figure was a vertical column of hieroglyphs giving titles of Reḫ-wer, but only the top part of the column remains:—

←↓ .

On the western side of the Open Court, opposite the first aperture of Serdab No. 14, is an Alabaster Altar set in mud (brick?) in a rectangular construction of local limestone (Pl. XXV, 2); the circular top of this great alabaster block is polished, but its sides have been left rough. (Compare the Alabaster Altar described on p. 31.)

The southern end of the Open Court was roofed over; the lower parts of two rectangular pillars with pilasters on either side remain *in situ*. On the four sides of each pillar were figures of Reḫ-wer sculptured in high relief (Pl. XXV, 1). Reḫ-wer is here represented standing with left leg forward and holding a long staff in one hand; only fragments of these sculptures are preserved. Round the base of each pillar is a casing of local limestone with mud (brick?) filling. The floor of the Open Court is cut in the living rock, but at the southern end (*i.e.* the part which was roofed over) there is a platform of local stone raised about 20 cms. above the main floor.

At the back of the pillars, at a distance of 1.06 ms., were five Niches built of limestone slabs (Niches 8 to 12); two opened northwards and three southwards. On either side of this group of

Niches is a pilaster showing that this part of Re \bar{c} -wer's tomb must once have been roofed over. Niches 8, 10, and 12 measure 63 cms. by 50 cms.; Niches 9 and 11, 92 cms. by 50 cms. The walls of each Niche were decorated with scenes of offering sculptured in relief. Only very faint traces of these scenes now remain; in Niche 9 is a representation of a bull being sacrificed.

The Serdab No. 14, on the eastern side of the Open Court, measures 9.75 ms. long by 1.05 ms. wide. It is built of coarse local stone against the Mastaba of Shaft No. 35, and was cased with slabs of Turah limestone. It has three apertures opening on to the Court, and each of these has before it a niche with raised platform to enable the visitor to mount and inspect the statues within

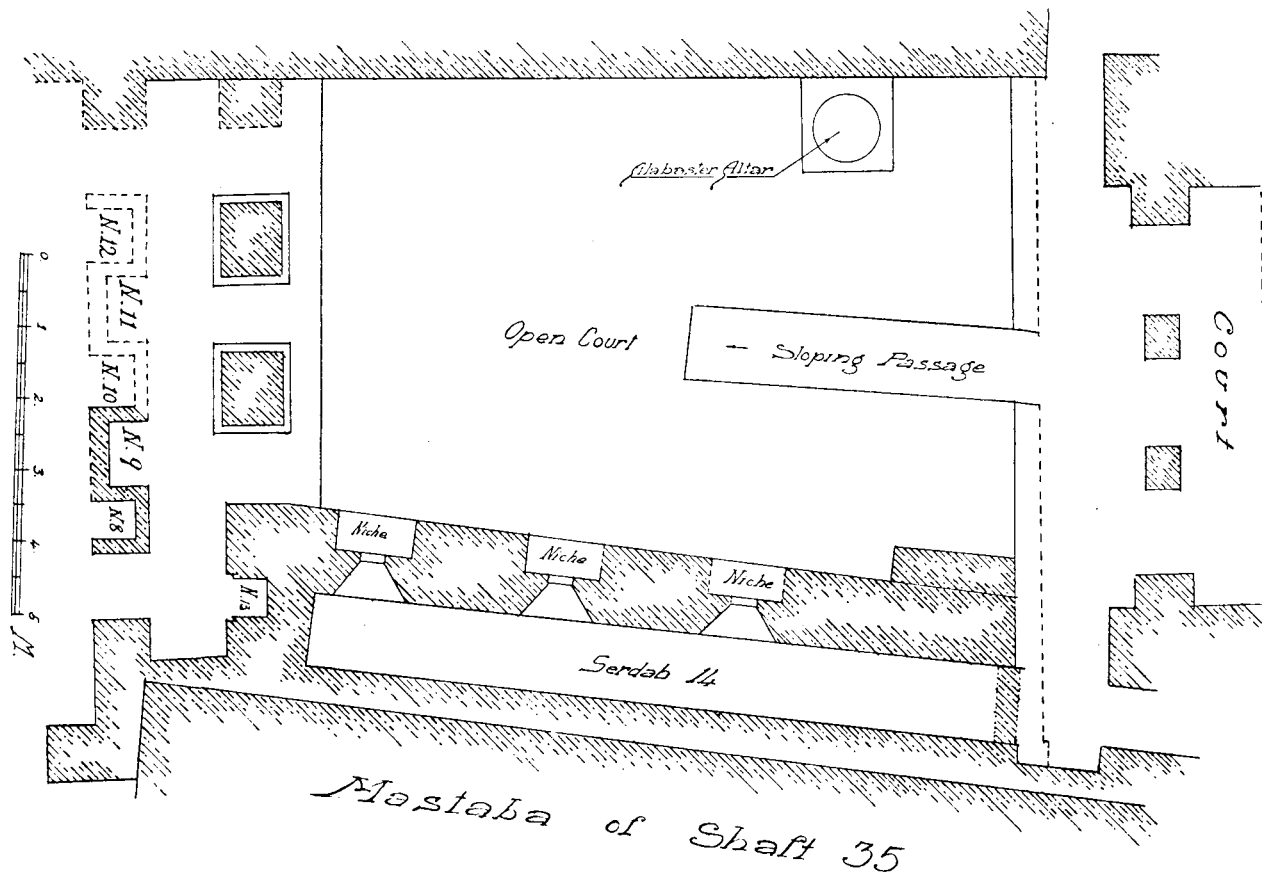

FIG. 15. Plan of the Open Court.

the Serdab. Two of these niches are well preserved and measure 1 m. by 45 cms. On the upper part of the eastern interior wall is a line of large hieroglyphs, incised, and giving the name and titles of Re \bar{c} -wer (fig. 16). For translations of these titles see pp. 2, 3. A fragment of a seated Statue of white limestone (Pl. XXIII, 2) was discovered lying in the sand near this Serdab; its head, legs, and left shoulder are missing. The right hand is closed and rests on the right thigh; the left hand lies open, palm downwards, on the left thigh. The man wears a loin-cloth crimped on one side and secured by a girdle, one end of which projects upwards. Around his neck was a necklace, but of it only traces of green paint remain. The skin is painted red. On the right side of the stool upon which the man sits is the top part of a vertical column of incised hieroglyphs reading $\leftarrow \downarrow \parallel \uparrow \uparrow \uparrow \uparrow$. These two titles leave no doubt that the statue was of Re \bar{c} -wer.

The beautiful fragment of the head of a Statue (Pl. XXIV) in white limestone, and the torso

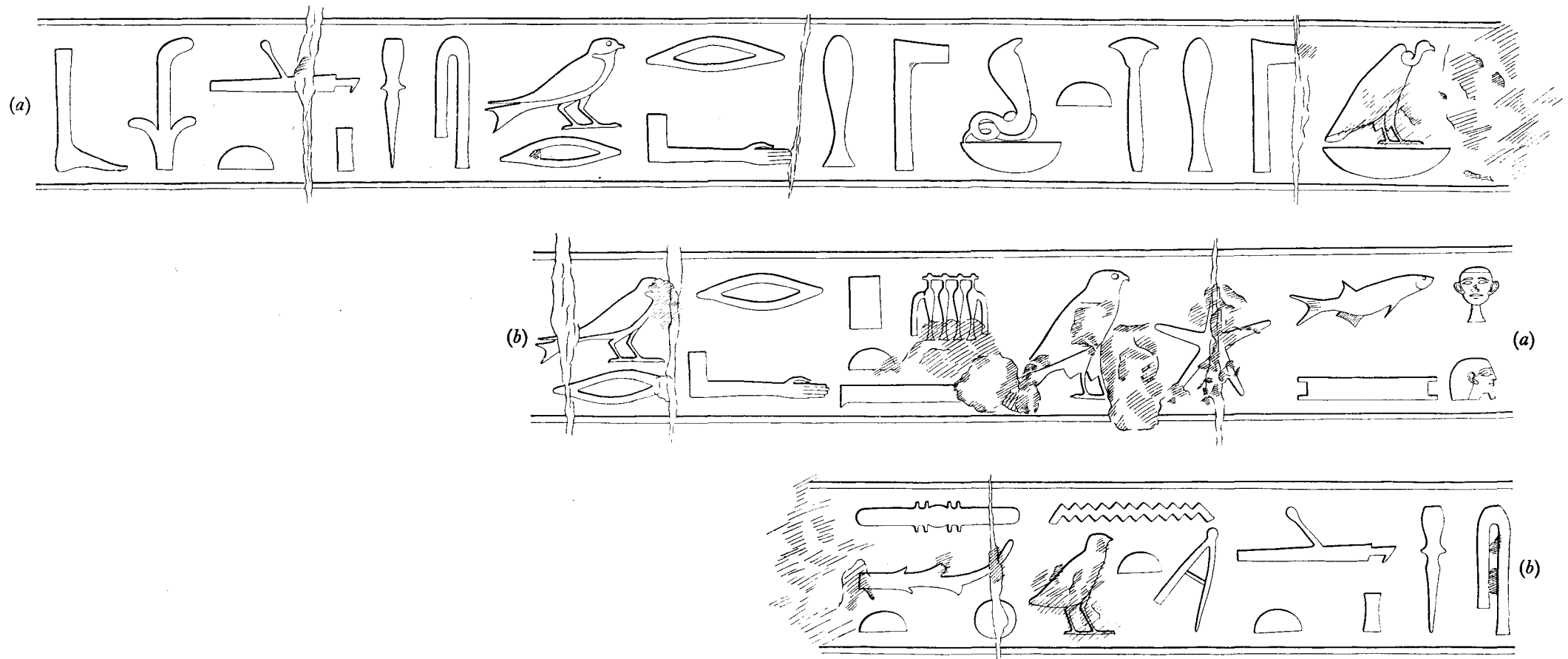

FIG. 16. Inscription along the top of the Eastern Wall of Serdab No. 14.

of another Statue (Pl. XXIII, 1) of the same material, were also brought to light from the sand near Serdab No. 14. This Serdab was used in later times as a burial-place; a desiccated body was found lying near the southern end of it.

At the north-eastern end of the roofed end of the Open Court is another Niche (N. 13), measuring 65 cms. by 50 cms. In it were found pieces of a black granite Statuette, the head of which is in excellent condition (Pl. XXXVIII, 2). The jambs of this Niche were sculptured with vertical columns of hieroglyphs in relief but only four signs remain:— ↓ → ☐ ♂ .

At the south-eastern end of the Open Court there is the entrance (90 cms. wide) to a sloping

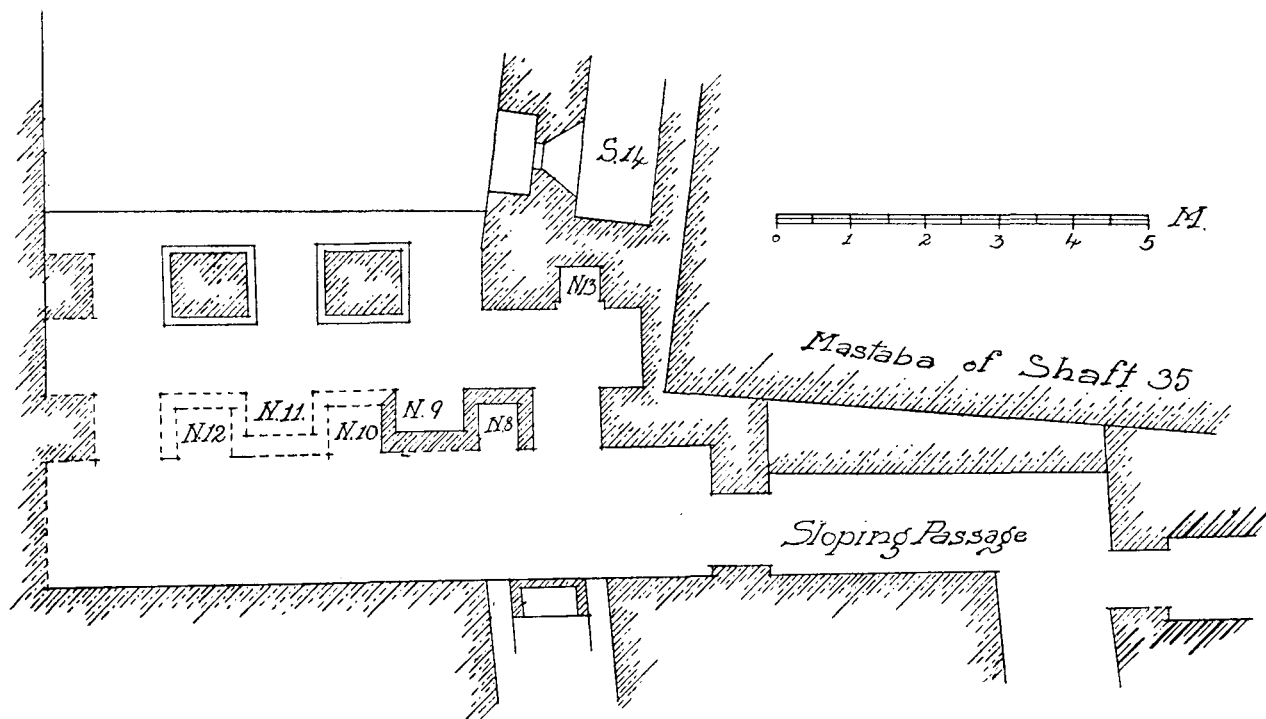

FIG. 17. Plan showing Sloping Passage leading to the Southern Buildings of Reo-wer's Tomb.

passage giving access to the southern chambers of Reo-wer's tomb. The jambs of this entrance were of white limestone, but only the lower part of the one on the left is preserved. The northern wall of this passage is built on to the southern wall of the Mastaba of Shaft No. 35. Its southern wall is the northern wall of Serdab No. 16.

Leading out of the passage at its eastern end is a Brick-built Chamber (Pl. XXVI), with Niche No. 14 at the end of it. The outer jambs of the doorway are of white limestone; the inner ones are set back 15 cms. and are of brick. The chamber itself measures 4.70 ms. long by 2.20 ms. broad. The walls are covered with a coating of yellow plaster (3.5 cms. thick) and white-washed. At the eastern end is NICHE No. 14, measuring 42 cms. by 36 cms., and reached by three steps of white limestone. The first step is elevated 38 cms. above the floor of the chamber; here was a door of two leaves; the socket-holes are still intact. At the back of the Niche was found in place the beautiful Alabaster Panel (Pls. XXVII and XXVIII) on which is sculptured a figure of Reo-wer standing with left leg advanced and arms hanging at his sides. He wears a long lined wig, short false-beard, and broad necklace. A broad band of cloth covering his left shoulder

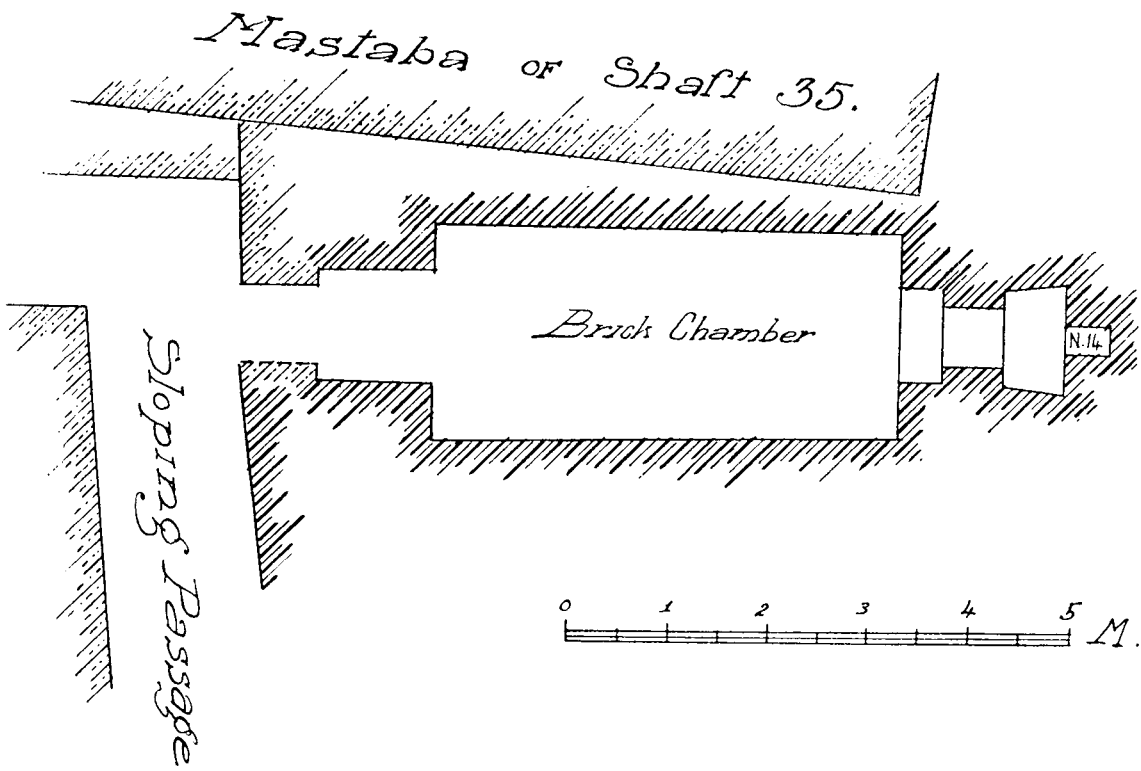

FIG. 18. Plan of Brick Chamber.

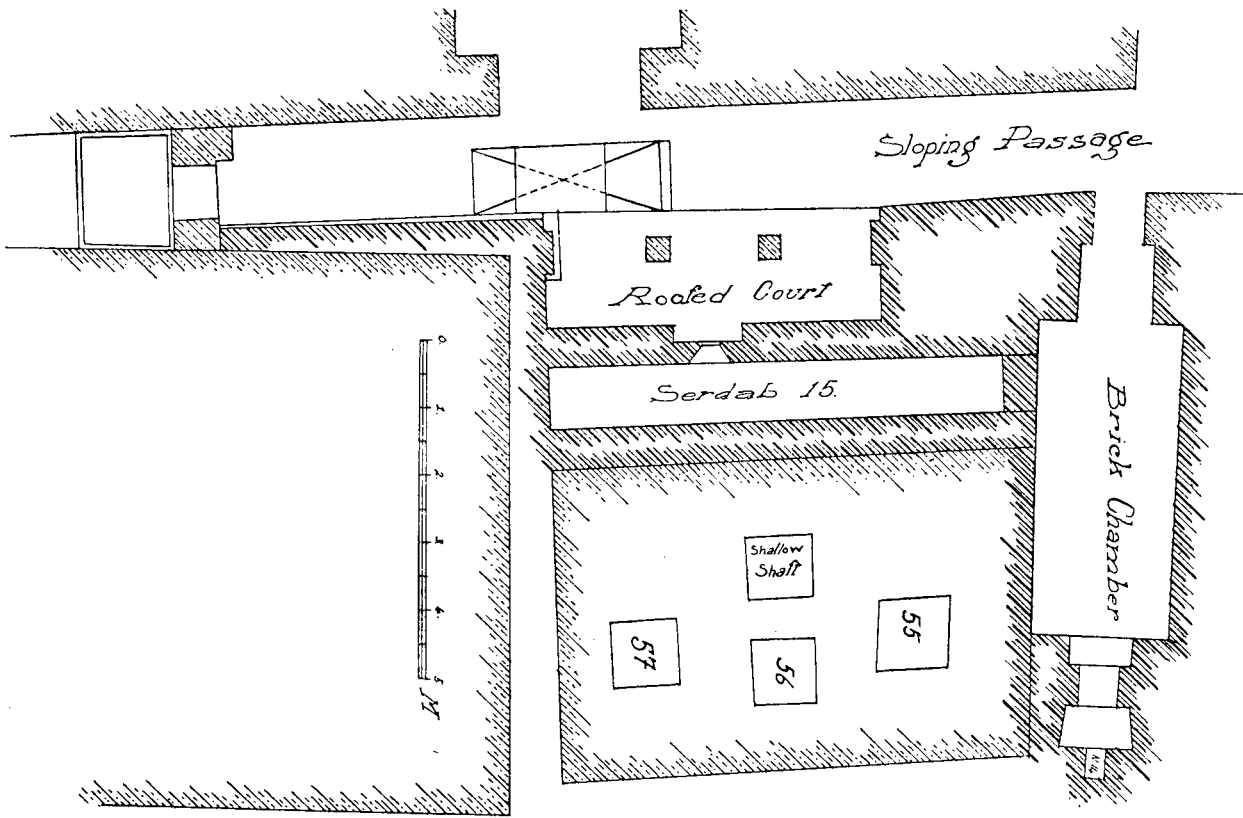
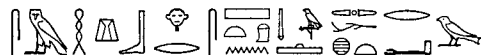

FIG. 19. Plan of Sloping Passage and of Roofed Court with Serdab No. 15.

passes round the chest under the right arm-pit. On his loins is a loin-cloth pointed in front. Above him is a horizontal line of incised hieroglyphs giving his name and titles:—



This panel is a very remarkable piece of sculpture and one of the most beautiful that has been preserved intact from the Old Kingdom. The head is in relief *en creux* exquisitely executed; from the shoulders downwards the figure is in simple incised outline.

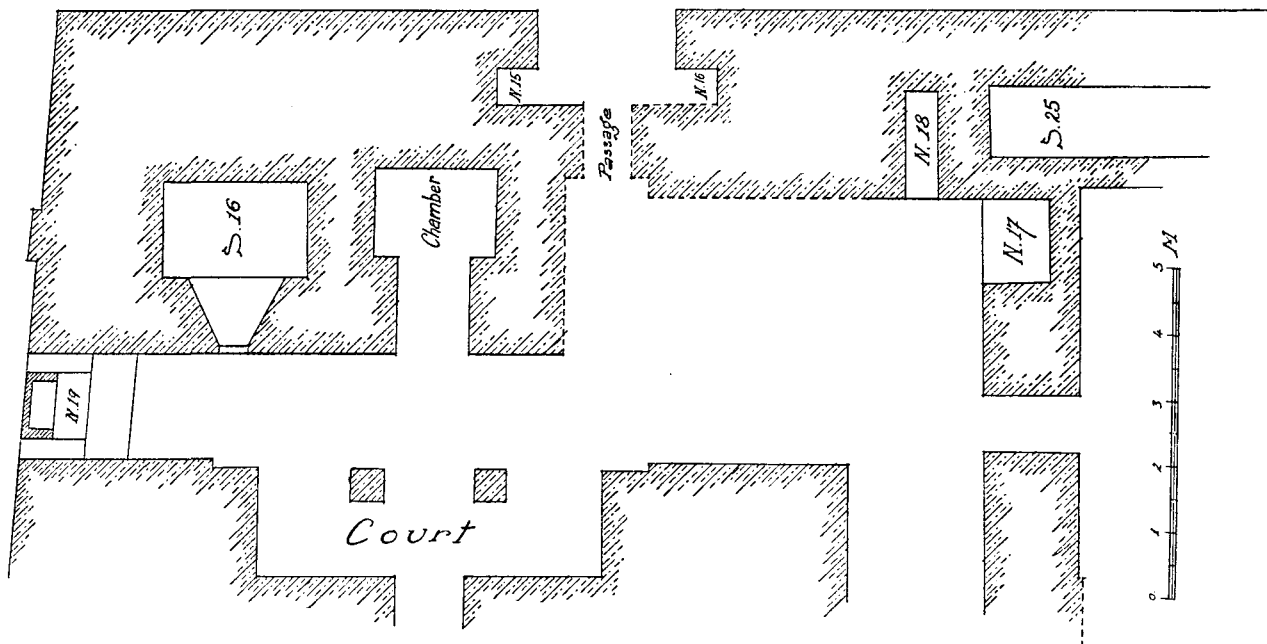



FIG. 20. Plan of Eastern Buildings in the Lower Court of Reo-wer's Tomb.

On the south side of the passage leading from the Roofed Court to the Brick Chamber with Niche No. 14 is the entrance to another passage, 1.52 ms. broad, sloping for a distance of 3.28 ms. but level for the rest of its length (9.50 ms.) (See fig. 18). This gives access to another Roofed Court, at the back of which is Serdab No. 15. The Court is 5.20 ms. long by 1.65 ms. broad and its roof was supported by pillars, 37 cms. square, with narrow pilasters on either side. The walls are of brick covered with a layer of plaster (3.5 cms. thick), and whitewashed. In the centre of the eastern wall is the aperture of a long brick-built Serdab (S. 15) measuring 7 ms. long by 87 cms. broad. Its eastern wall is built against the western wall of a small limestone Mastaba lying outside the boundary of Reo-wer's tomb. The floor is elevated about 55 cms. above the level of the floor of the Roofed Court in front of it. Near the centre of the level part of the passage is a shallow pit that was originally covered with five slabs of white limestone but only three are now preserved. Two pottery vases (Pl. LXXX, C, bottom row, left) were found at either end of this pit, which would perhaps suggest that it had been used for libation purposes.

At the southern end of the passage was a Niche (?) with doorway; the door was of one leaf, but the original structure here is too much destroyed to give any real clue as to its purpose.

In front of the Roofed Court is the entrance, 2.12 ms. wide, to another series of chambers built on a lower level than the central part of the tomb. On either side of the entrance are two

small Niches (N. 15 and 16), both measuring 1·28 ms. by 55 cms. Pieces of a granite Statuette were found in Niche 15, and near Niche 16 were the feet and base of one in limestone (Pl. XLI, 23). Beyond these Niches is a short narrow passage, 1·10 ms. by 74 cms., with doorway at end giving access to a large Court containing many Serdabs.

To the north is, on the east wall, a rectangular chamber measuring 1·90 ms. by 1·10 ms., which had a door in one leaf; the socket-stone (Pl. XXXVII, 1) was found in place and some of ReḲ-wer's titles are inscribed upon it:—.

Further on is the aperture of Serdab No. 16; it measures 45 cms. wide on the outside and 1·50 cms. on the inside. The Serdab itself measures 2·30 ms. by 1·50 ms. Its outer wall, of slabs of fine white limestone, was decorated with scenes in low relief, and painted; a fragment of an agricultural scene (fig. 21) remains in place.

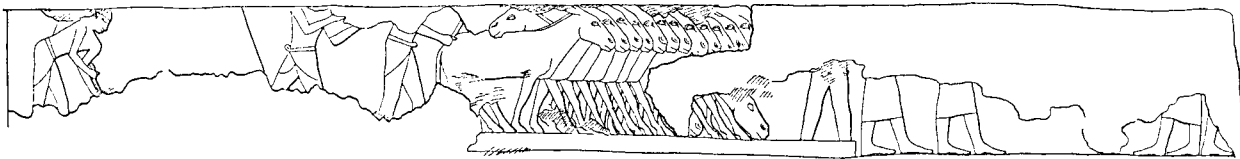







FIG. 21. Fragment of an Agricultural Scene.

At the end of the passage with Serdab No. 16 is a Niche (N. 19) measuring 1·65 ms. by 1 m., in which there was a Statue larger than the life, in a Naos. Both Statue and Naos are cut out of a single block of limestone; only the right leg and the lower part of the Naos remain *in situ*; the name of ReḲ-wer, with one of his titles, is incised near the foot:—. On the outer face of the right-hand side of the Naos is incised the name of ReḲ-wer.

The east wall, south of the passage leading from the Roofed Court, was cased with white limestone slabs sculptured in low relief with religious scenes. Of these only a fragment remains *in situ* at the southern end (Pl. XXIX). Here were two registers. In the uppermost there is a figure of a priest facing to the right, holding in his left hand a censer and raising its lid with his right hand. He wears a loin-cloth, and before him is incised his name and title:—

 'The Inspector of the *Ka*-servants, Shepseskaf-rankh'. Behind him was another male figure, in front of whom is incised:— 'The Sealer, Menu'. In the lower register is the upper half of a male figure offering a joint of meat: in front of him is his name and title:— 'The Instructor of the *Ka*-servants, Ha-ib'. Immediately adjoining this scene on the right is Niche 17, which is cut out of the living rock; it is 1·20 ms. long by 97 cms. wide and its present height is 2 ms.

Opposite the passage-way from the Roofed Court leading into the series of buildings on the lower level of the tomb is another Court with two rectangular pillars, showing that it was once roofed (see fig. 22). In its northern wall is Serdab No. 17 measuring 1·35 ms. by 75 cms.; it contained the pedestal and foot of a standing limestone Statue of ReḲ-wer (Pl. XXXIX, 5). On the pedestal is engraved his name and title:—.

Adjoining Serdab No. 17 in the western wall is another (S. 18), measuring 2·10 ms. by 1·48 ms.; its aperture faces east and there was a window in its southern wall. In it is the pedestal of a large

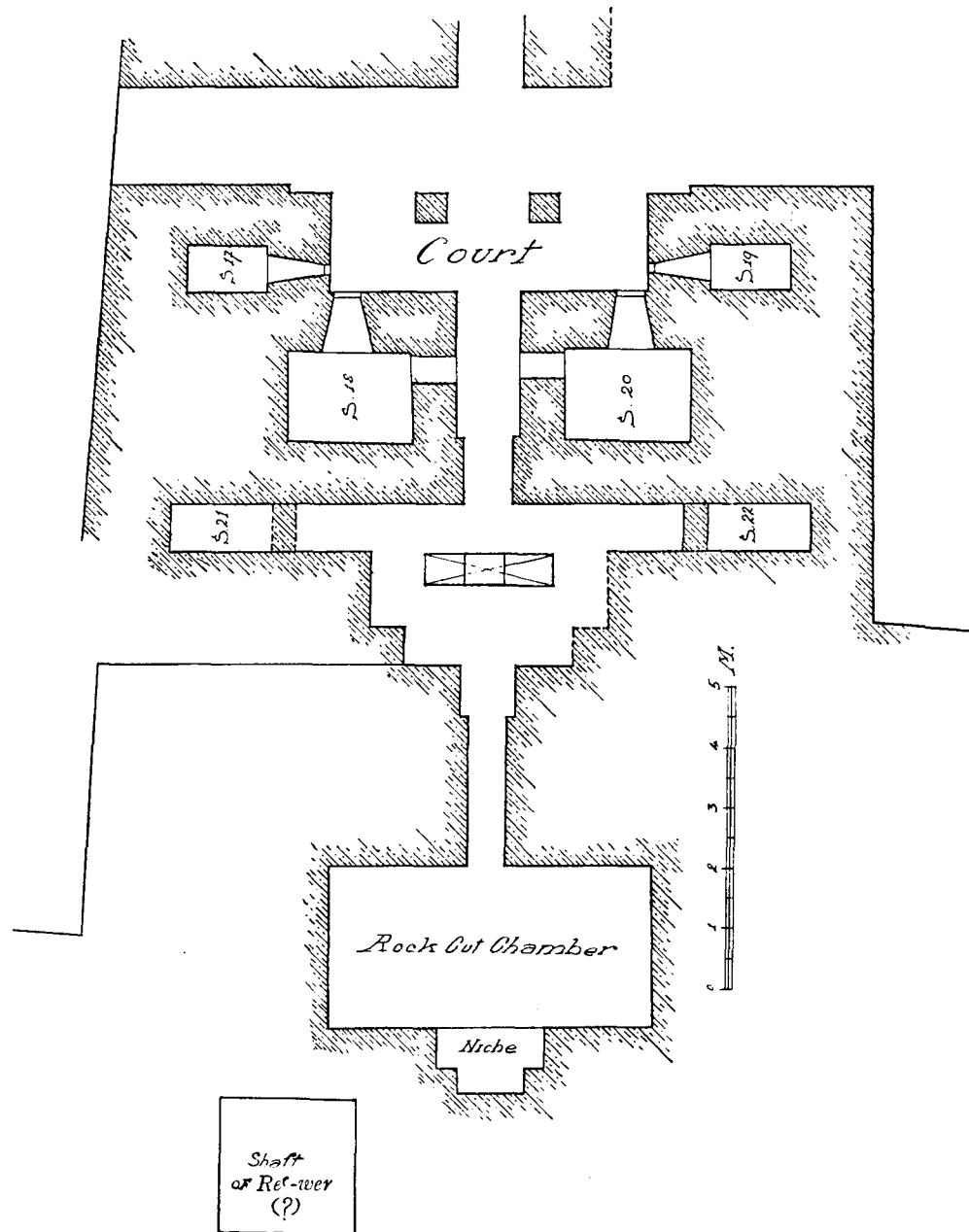
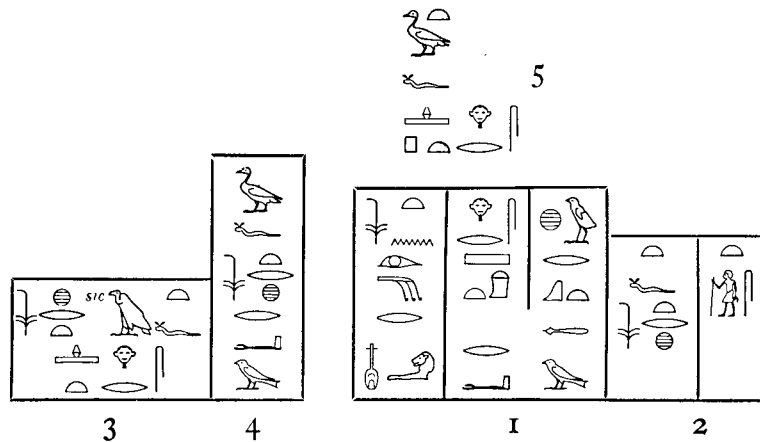

FIG. 22. Plan of the Rock-cut Chamber with Serdabs before it.

Statue Group with the remains of the feet of five persons (Pl. XXX, 1), namely, ReḲ-wer (1), his father (2), mother (3), son (4), and daughter (5). The inscriptions¹ referring to these figures are incised by their feet and read: ←



On the southern side of the Roofed Court were two more Serdabs (S. 19 and S. 20), similar in plan and size to those on the northern side. Serdab No. 19 contained the pedestal of a limestone Statue of ReḲ-wer inscribed with his name and titles (Pl. XXX, 2); the inscription reads: (1) ; (2) . Serdab No. 20 contained the pedestals of two Standing Figures in limestone, one of which (Pl. XXX, 3) is inscribed with ReḲ-wer's name and titles: .

At the back of the Roofed Court is a passage-way, 2.75 ms. long by 1.05 broad, leading to a doorway that gives access to a Court with shallow Libation Pit in the centre like the one on the eastern side of the lower level tomb-buildings. This pit was covered in the middle by a slab of limestone. To north and south of it are narrow passages with Serdabs (S. 21 and S. 22) at the end.

Serdab No. 21 measures 1.70 ms. by 75 cms. and contained fragments of a Seated Statue of limestone, the pedestal and feet of which were *in situ*. The outer wall of this Serdab has disappeared.

Serdab No. 22, of the same dimensions as S. 21, contained the pedestal of a limestone Statue, but it, like that in S. 21, is uninscribed.

To the west of the Libation Pit is a large Chamber excavated in the living rock (Pl. XXXI). Its outer face is cut in imitation of the courses of a stone-built Mastaba. On each side of the entrance are two recesses cut in the rock; they were perhaps for white limestone stelae. In the one on the right-hand side—*i.e.* the northern side—was fixed a large limestone slab which projects outwards.

The entrance to the Rock-cut Chamber was flanked by two outer jambs of white limestone, and two inner jambs cut in the living rock, these latter have two sloping depressions cut in the middle of them measuring about 75 cms.; whether they belong to the original design of the tomb is not apparent.

The passage leading into the Rock-cut Chamber is 3.25 ms. long and 60 cms. broad. The Chamber itself is rectangular, 5.35 ms. across by 2.75 ms. broad. In the centre of the inner-

¹ For the translations of these names and titles see pp. 2, 3.

most wall is a recess 1.10 ms. deep by 1.75 ms. across; this recess was probably for a white limestone False-door. At the left of this recess, at a height of 1.90 ms., is carved a small False-door measuring about 30 cms. by 10 cms.

Behind this Rock-cut Chamber, a short distance to the north-west, is a large Shaft, 2.15 ms. by

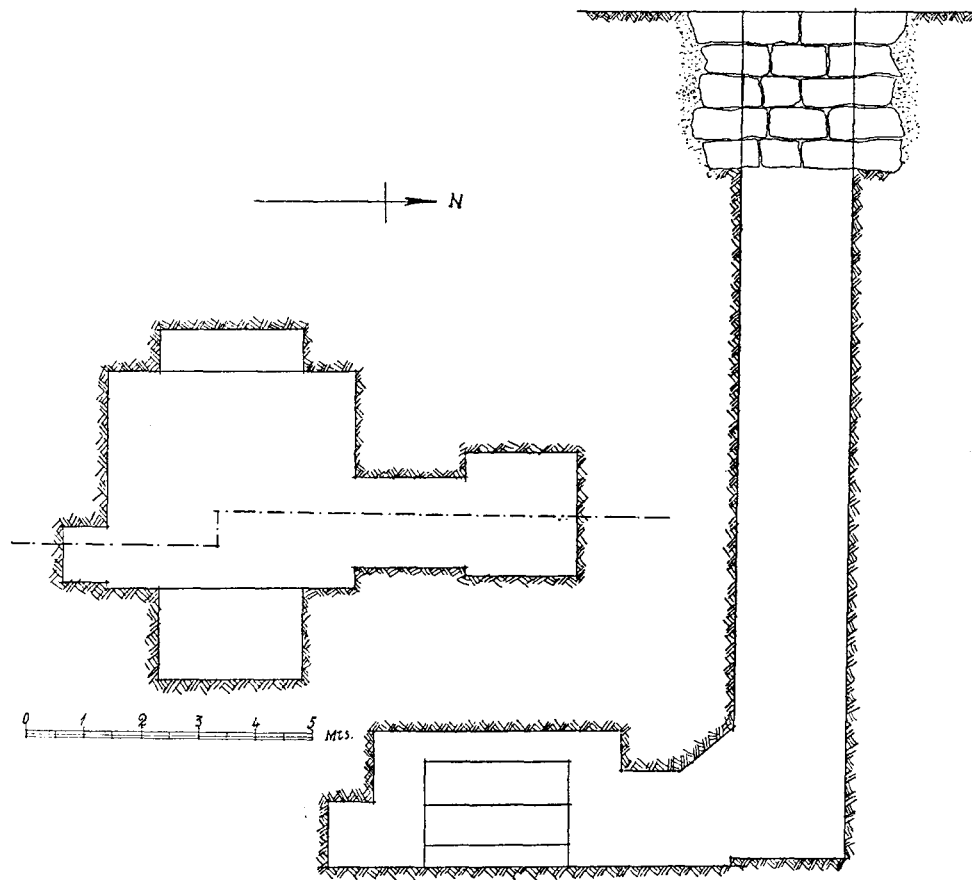









FIG. 23. Plan and Section of the Shaft and Sarcophagus Chamber behind the Rock-cut Chamber.

1.95 ms. at the top, and 14.95 ms. in depth, with a Sarcophagus Chamber at the bottom (fig. 23). This Sarcophagus Chamber is lined with slabs of white limestone and lies to the south of the Shaft; it measures 6.10 ms. by 3.82 ms. by 2.20 ms. Its aperture is 2.30 ms. by 1.65 ms. by 1.95 ms. The chamber is filled with water and it has not been possible as yet to explore it thoroughly.

A short distance to the west of Niche No. 17 in the southern wall of the Court containing Serdabs Nos. 16 to 22 there is an entrance, 80 cms. wide, giving access to a narrow Hall, 5.95 ms. long by 1.25 ms. broad. The jambs of this entrance are of fine Turah limestone and were inscribed with two vertical lines of hieroglyphs, but only the lower signs of the inscription on the left jamb are preserved: $\leftarrow \downarrow$ (1)    ; (2)    . At the eastern end of the Hall is Serdab No. 25; it measures 3.40 ms. by 1.10 ms., and had two apertures, one on the western side opening in the eastern wall of the Hall, and one in the southern wall opening on to the Mastaba of Akhetetep (see p. 73). In the southern wall of the Hall facing the entrance is a large recessed Niche (N. 20) and the aperture to Serdab No. 24. The Niche measures 1.50 ms. by 1 m. and had a door in two leaves in front of it. The threshold, of white limestone, is raised 37 cms. above

the level of the Hall floor, and the Niche floor is raised 58 cms. above the threshold. The walls were cased with slabs of fine white limestone and the inner one was probably sculptured with a figure of ReḲ-wer in relief. This Niche was used in later times as a burial-place and in its floor is cut a shaft with Sarcophagus chamber at the bottom running south.

In the Hall wall to the left of Niche 20 is the aperture to Serdab No. 24; in front of this aperture was a step of white limestone. The Serdab measures 1.25 ms. by 1.15 ms., and in it is a

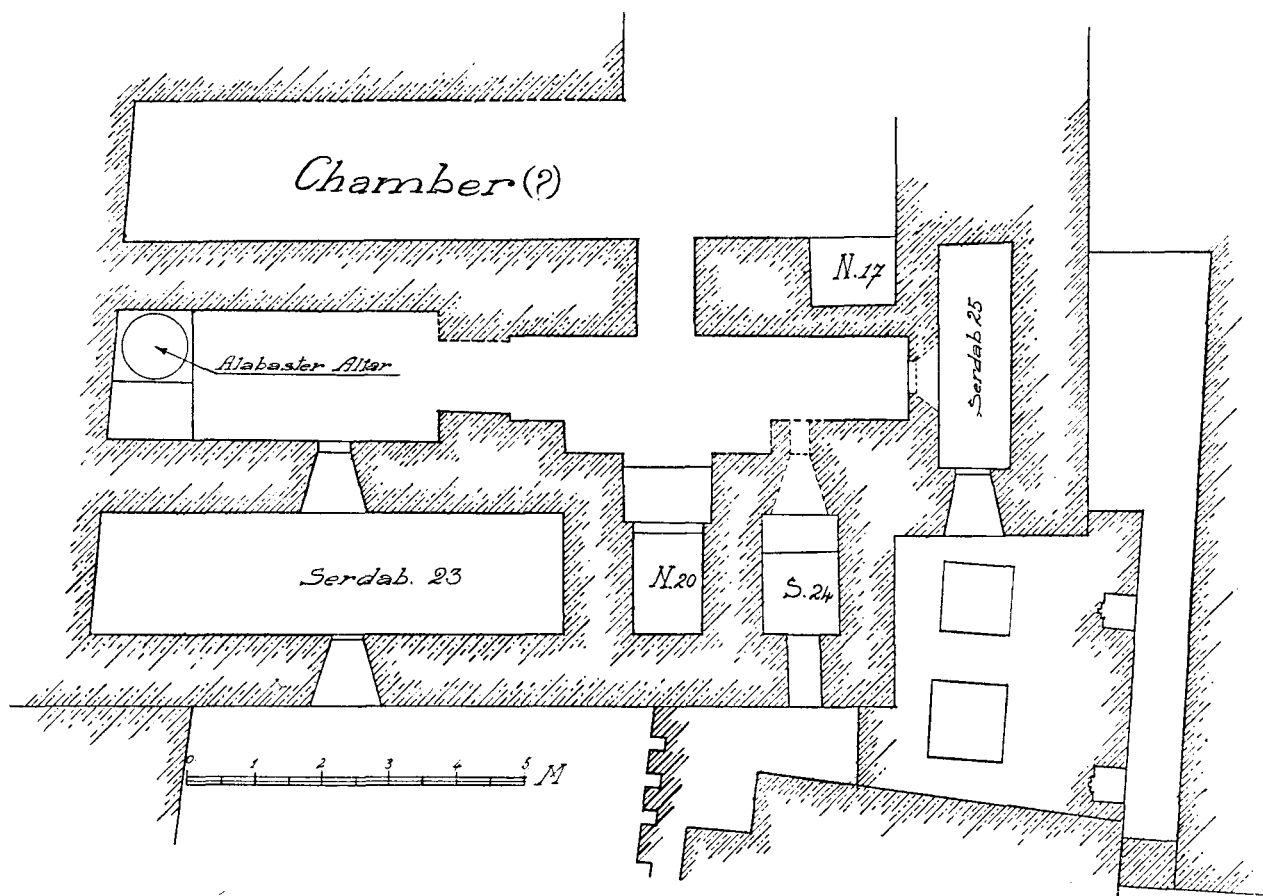

FIG. 24. Plan of the Southernmost Chambers of ReḲ-wer's Tomb.

raised platform cut in the native rock for the reception of the Statue. In the Serdab's southern wall is a narrow opening or window.

At the western end of the Hall is the entrance to an Offering Chamber measuring 4.85 ms. long by 1.90 ms. broad. At its inner end is a large Alabaster Altar (Pl. XXXII) about 95 cms. in diameter, cut out of a great block of stone. The upper surface is circular and polished; the back and sides have been left rough and were embedded in mud framed by limestone blocks like the Altar in the Open Court (see p. 21). The eastern face is flat and has a rectangular panel with a figure of ReḲ-wer sculptured in relief upon it (fig. 25). Here ReḲ-wer is represented standing with left leg forward; in his right hand is a \dagger -baton and in his left a long staff. He wears a medium-length lined wig, a necklace, loin-cloth, and the panther-skin robe of a *Sem*-priest. Above and on both sides of him are inscriptions giving his name and titles.

In the southern wall of the Offering Chamber is the opening to Serdab No. 23. This is the

largest and best preserved Serdab in the tomb; it measures 6.88 ms. long by 1.80 ms. broad, and 2.75ms. high. The roof consists of six large slabs of local stone. In the centre of its southern wall there is an aperture opening on to the large Courtyard of an uninscribed Mastaba (see p. 89).

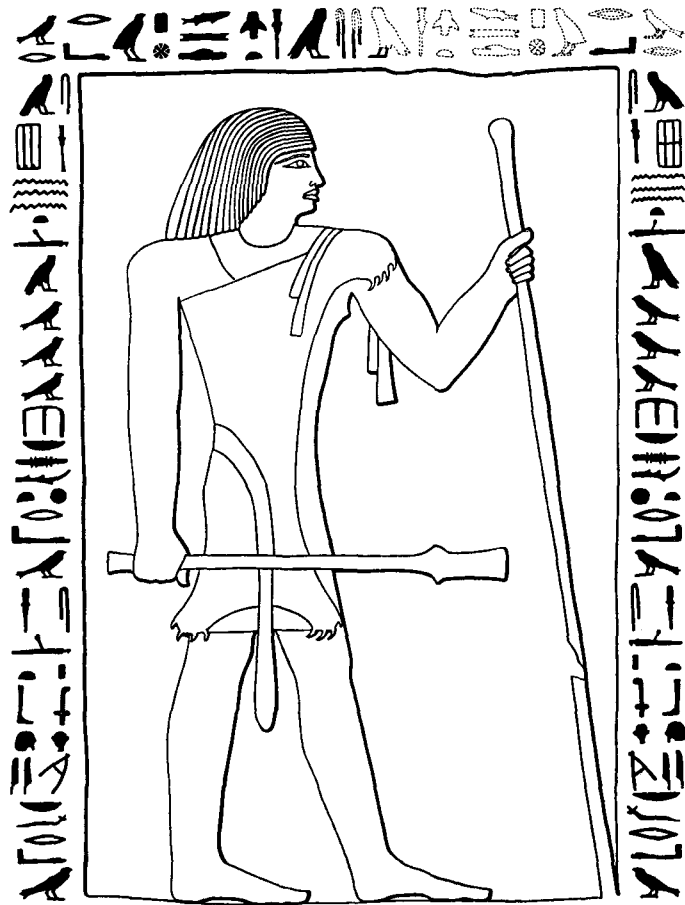

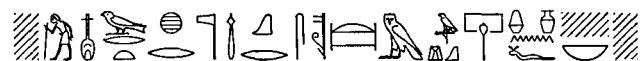





FIG. 25. The Sculptured Panel of the Alabaster Altar.

MISCELLANEOUS INSCRIBED AND SCULPTURED SLABS FOUND IN THE TOMB OF RE'-WER

1. UPPER PART OF A SLAB OF WHITE LIMESTONE (Pl. XXXIII, 1.) Height, 22 cms. Length, 91 cms. Sculpture in low relief, painted. Two men facing left; their heads alone are preserved. Behind the first figure was a vertical column of hieroglyphs; of this only the first two signs remain, . Above the figures is a horizontal line of inscription reading:—



2. UPPER PART OF A SLAB OF WHITE LIMESTONE (Pl. XXXIII, 2). Height, 25 cms. Length, 25 cms. Sculpture incised and painted. Head and shoulders of a male figure standing and facing to the right; before him was a vertical column of hieroglyphs beginning ; behind him was another column of hieroglyphs beginning .

3. UPPER PART OF A SLAB OF WHITE LIMESTONE (Pl. XXXIII, 3). Height, 25 cms. Length, 60 cms. Sculpture incised, figures painted red. Remains of two male figures facing to the right. Of the first the head and upper part of the body is preserved; of the second only part of the left shoulder and arm, and right hand resting on top of a staff, remain. Before the second figure is the upper part of a vertical column of inscription reading .
4. FRAGMENT OF A SLAB OF WHITE LIMESTONE (Pl. XXXIV, 1). Height, 30 cms. Breadth, 16 cms. Sculpture in low relief. A male figure carrying a box; behind him are his titles .
5. FRAGMENT OF A SLAB OF WHITE LIMESTONE (Pl. XXXIV, 2), and fig. 26. Height, 50 cms. Length, 75 cms. Sculpture in low relief and painted. Parts of two registers. Upper register, a detail from an agricultural scene, *cf.* Steindorff, *Das Grab des Ti*, pl. 124. Lower register, fragment of a scene of sailors in canoes tilting, *cf.* Klebs, *Die Relief des alten Reiches*, p. 115.

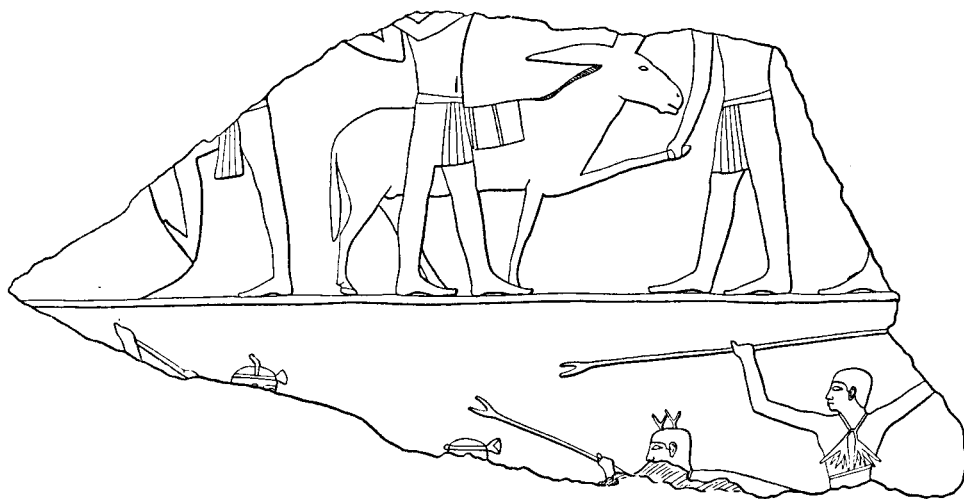

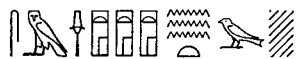

FIG. 26. Fragment of a Sculptured Limestone Slab.

6. FRAGMENT OF A SLAB OF WHITE LIMESTONE (Pl. XXXIV, 3). Height, 12 cms. Length, 17 cms. Sculpture in low relief. Scene, birds.
7. PORTION OF A SLAB OF WHITE LIMESTONE (Pl. XXXIV, 4). Height, 57 cms. Breadth, 16 cms. Sculpture in low relief, painted. In the four uppermost registers, offerings of vegetables, bread, &c., coloured yellow and green. Lower register, a man facing to the left; above him two hieroglyphs .
8. FRAGMENT OF A SLAB OF WHITE LIMESTONE (Pl. XXXIV, 5). Height, 26 cms. Breadth, 33 cms. Sculpture, low relief, painted. Two men facing to the right; only the middle part of the first figure is preserved; of the second the legs have been broken away. The second figure is a scribe in the act of writing on a tablet.
9. FRAGMENT OF A SLAB OF WHITE LIMESTONE (Pl. XXXIV, 6). Height, 14 cms. Length, 26 cms. Sculpture, low relief, painted. Upper part of a figure of Re'-wer wearing a panther-skin robe, faces to the right. Before him is a vertical column of hieroglyphs giving his titles:—



10. FRAGMENT OF A SLAB OF WHITE LIMESTONE (Pl. XXXIV, 7). Height, 25 cms. Breadth, 37 cms.

Sculpture, low relief, painted. Detail of a vineyard scene; men gathering bunches of grapes, painted blue, from the vines, and loading them in baskets.

11. SLAB OF WHITE LIMESTONE (Pl. XXXV, 3). Height, 70 cms. Breadth, 40 cms. Sculpture, low relief. Three vertical columns of hieroglyphs and fragments of two others, reading \downarrow , and giving titles and name of *Rer-wer*:

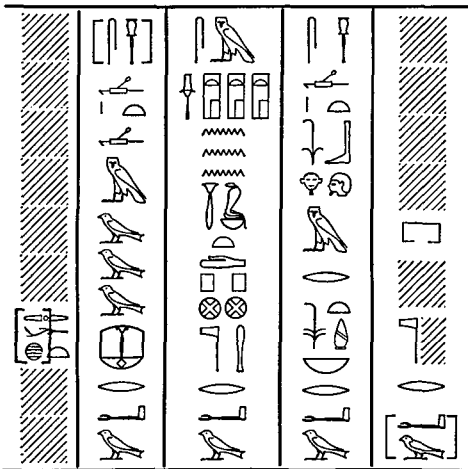

12. TWO SLABS OF WHITE LIMESTONE (Pl. XXXVI, 1). Height of the two pieces, 65 cms. Breadth, 16 cms. Sculpture, low relief. A vertical column of hieroglyphs reading $\leftarrow\downarrow$, giving titles of *Rer-wer*: .

13. FRAGMENT OF A SLAB OF WHITE LIMESTONE (Pl. XXXVI, 2). Height, 15 cms. Breadth, 16 cms. Sculpture, low relief. A vertical column of hieroglyphs reading \downarrow , giving titles of *Rer-wer*:

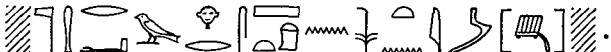

14. FRAGMENT OF A SLAB OF WHITE LIMESTONE (Pl. XXXVI, 3). Height, 23 cms. Breadth, 12 cms. Sculpture, incised. Lower part of a vertical column of hieroglyphs reading \downarrow , and giving name of *Rer-wer*: .

15. FRAGMENT OF A SLAB OF WHITE LIMESTONE (Pl. XXXVI, 4). Height, 65 cms. Breadth, 16 cms. Sculpture, low relief. A vertical column of hieroglyphs reading $\leftarrow\downarrow$, and giving titles of *Rer-wer*: .

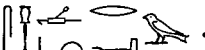
16. FRAGMENT OF A SLAB OF WHITE LIMESTONE (Pl. XXXVI, 5). Height, 21 cms. Breadth, 17 cms. Sculpture, incised. Lower part of a vertical column of hieroglyphs reading \downarrow , and giving name and title of *Rer-wer*: .

17. FRAGMENT OF A SLAB OF WHITE LIMESTONE (Pl. XXXVI, 6.) Height, 30 cms. Breadth, 35 cms. Sculpture, incised. Lower ends of three vertical columns of hieroglyphs reading \downarrow , and giving name and titles of *Rer-wer*:

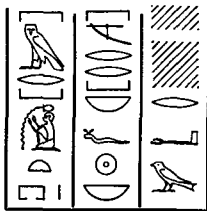

18. FRAGMENT OF A SLAB OF WHITE LIMESTONE (Pl. XXXVI, 7). Height, 35 cms. Breadth, 25 cms. Sculpture, incised. Part of a vertical column of hieroglyphs reading ←↓, giving titles of Re^c-wer:



19. FRAGMENT OF A SLAB OF WHITE LIMESTONE (Pl. XXXVI, 8). Height, 47 cms. Breadth, 20 cms. Sculpture, incised. Upper part of a vertical column of hieroglyphs, reading ←↓, giving titles of Re^c-wer:



20. FOUR FRAGMENTS OF A SLAB OF WHITE LIMESTONE (Pl. XXXVII, 2). Height, 71 cms. Breadth, 28 cms. Sculpture, low relief. Two vertical columns of hieroglyphs, reading ↓↔, giving prayer for, and titles of, Re^c-wer:



21. PART OF A SLAB OF WHITE LIMESTONE (Pl. XXXVII, 3). Height, 55 cms. Breadth, 31 cms. Sculpture, low relief. The upper parts of three vertical columns of hieroglyphs, reading ←↓, giving titles of Re^c-wer:

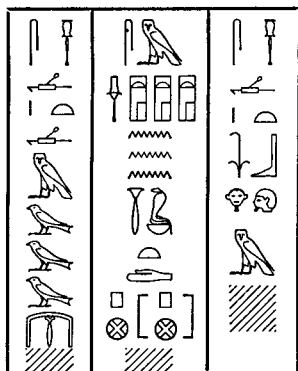



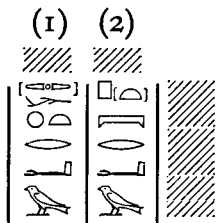

22. FRAGMENT OF A SLAB OF WHITE LIMESTONE (Pl. XXXVII, 4). Height, 14 cms. Breadth, 24 cms. Sculpture, low relief. The lower parts of two vertical columns of hieroglyphs reading ←↓, giving the name and parts of titles of Re^c-wer:

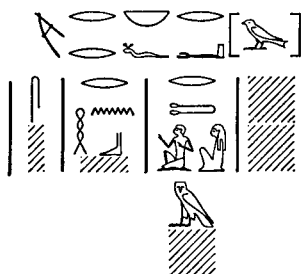

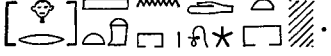
23. FRAGMENT OF A SLAB OF LIMESTONE (Pl. XXXVII, 5). Height, 39 cms. Breadth, 52 cms. Sculpture, incised. Fragments of an inscription reading ←↓:

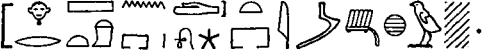

24. FRAGMENT OF A SLAB OF WHITE LIMESTONE (Pl. XXXVII, 6). Height, 33 cms. Breadth, 20 cms. Sculpture, low relief. Part of a vertical column of hieroglyphs, reading $\leftarrow\downarrow$, giving titles of Re \bar{c} -wer: .
25. FRAGMENT OF A SLAB OF LIMESTONE (Pl. XXXVII, 7). Height, 28 cms. Breadth, 27 cms. Sculpture, incised. A vertical column of hieroglyphs giving the name of Re \bar{c} -wer with title: .
26. FRAGMENT OF A BLOCK OF WHITE LIMESTONE FROM THE CORNER OF A WALL (Pl. XXXVII, 8.) Height, 78 cms. Breadth, 27 cms. Sculpture, incised. On one face is a vertical column of hieroglyphs reading: . On the other face is the lower part of a male figure, in front of whom is a place-name: . This place-name appears also on a slab in the Offering Hall (see p. 11.)

FRAGMENTS OF STATUES AND STATUETTES FOUND IN THE TOMB OF RE \bar{c} -WER

1. HEAD OF A LARGE STATUE (Pl. XXXVIII, 1). Limestone. Found to the west of the principal Serdab (S. 12). Height, 32 cms. This head is in a very mutilated condition.
2. STATUETTE OF A WOMAN SEATED ON A STOOL (Pl. XXXIX, 1). Limestone, broken into two pieces. Found in the debris of the Offering Hall. Height, 25 cms. Breadth of chest, 9 cms. Short full wig; long close-fitting garment; the hand of the right arm rests upon the right thigh. The arms from the elbows downwards are broken away, and the left hand is wanting. The carving is poor.
3. FRAGMENT OF THE LEFT SIDE OF THE HEAD OF A STATUETTE (Pl. XXXIX, 4). Limestone. Found on the west of the principal Serdab (S. 12). Height, 11 cms. The face is painted red, the eyebrows and lashes, black.
4. FRAGMENT OF THE UPPER PART OF THE HEAD OF A SMALL STATUETTE OF A MAN. Limestone. Found in the Passage to the north of Serdab No. 23.
5. FRAGMENT OF THE HEAD-DRESS, painted black, of a limestone Statuette (Pl. XL, 1). Height 18 cms. Found in the sand above Serdabs Nos. 17 and 18.
- 6-10. FIVE FRAGMENTS OF HEAD-DRESSES OF LIMESTONE STATUETTES (Pl. XL, 2, 4, 5, 11, and 14). Found in the sand in different parts of the tomb.
11. FRAGMENT OF THE RIGHT SIDE OF A HEAD-DRESS, painted black, of a limestone Statuette (Pl. XL, 6). Found in the sand above Serdabs Nos. 17 and 18.
12. FRAGMENT OF THE PEDESTAL OF A LIMESTONE STATUETTE, with toes of the left foot (Pl. XL, 7).
13. FRAGMENT OF A LIMESTONE STATUETTE (Pl. XL, 8). Right hand open with palm downwards resting on thigh. Length, 21 cms. Found above the Rock-cut Chamber.
14. FRAGMENT OF THE PEDESTAL OF A STATUETTE, with the left foot alone preserved (Pl. XL, 9). Height of foot, 3 cms.

15. FRAGMENT OF THE FACE OF A LIMESTONE STATUETTE (Pl. XL, 12). Height, 27 cms. Found near Serdab No. 18.
16. FRAGMENT OF THE LEFT SHOULDER OF A STATUE (Pl. XL, 15). Breadth, 19 cms. Found in the sand-filling of Serdab No. 19.
17. FRAGMENT OF THE ARM OF A LIMESTONE STATUETTE (Pl. XL, 16). Length, 30 cms. Found in a Serdab in front of the Rock-cut Chamber.
18. FRAGMENT OF THE ARM OF A LIMESTONE STATUE (Pl. XL, 17). Length, 31 cms. Found in the sand above Serdab No. 19.
19. FRAGMENT OF THE RIGHT SHOULDER OF A LIMESTONE STATUE (Pl. XL, 18). Breadth, 26 cms. Found in Niche No. 12.
20. FRAGMENT OF THE RIGHT ARM OF A STATUE (Pl. XL, 19). Length, 38 cms. Found on the eastern side of the outer wall of the Rock-cut Tomb.
21. FRAGMENT OF THE LEG OF A LIMESTONE STATUE (Pl. XL, 20). Length, 33 cms. Found in Serdab No. 17.
22. FRAGMENT OF THE LEFT LEG WITH KNEE AND THIGH OF A LIMESTONE STATUE (Pl. XL, 21). The left hand rested on the thigh, palm downwards. Length, 36 cms. Found outside Serdab No. 20.
23. FRAGMENT OF THE RIGHT ARM OF A LIMESTONE STATUE (Pl. XL, 22). Length, 59 cms. Found to the west of the principal Serdab (S. 12).
24. FRAGMENT OF THE ARM OF A LIMESTONE STATUE (Pl. XL, 23). Found near Serdab No. 14.
25. FRAGMENT OF A CLOSED HAND OF A LIMESTONE STATUE (Pl. XLI, 1). Length, 20 cms. Found in the southern part of the Tomb.
26. FRAGMENT OF THE LEFT FOOT OF A LIMESTONE STATUE (Pl. XLI, 2). Length, 19 cms. Found in Serdab No. 19.
27. FRAGMENT OF THE RIGHT FOOT OF A LIMESTONE STATUE (Pl. XLI, 3). Length, 15 cms. Found in Serdab No. 17.
28. FRAGMENT OF THE LOWER PART OF THE FACE OF A LIMESTONE STATUE (Pl. XLI, 4). Height, 11 cms. Found in the pathway leading to Serdab No. 13.
29. FRAGMENT OF A CLOSED HAND OF A LIMESTONE STATUETTE (Pl. XLI, 5). Length, 8 cms. Found in the sand-filling of Serdab No. 25.
30. FRAGMENT OF THE LEFT ARM OF A LIMESTONE STATUE (Pl. XLI, 6.) Length, 16 cms. Found near Serdab No. 20.
31. FRAGMENT OF THE SHOULDER OF A LIMESTONE STATUE (Pl. XLI, 7). Height, 15 cms. Found near Serdab No. 14.
32. FRAGMENT OF THE RIGHT ARM OF A LIMESTONE STATUE (Pl. XLI, 8). Length, 15 cms. Found in the pathway leading to Serdab No. 13.
33. FRAGMENT OF THE MIDDLE PART OF A LIMESTONE STATUETTE OF A MAN IN KNEELING POSTURE (Pl. XLI, 9). Height, 15 cms. Found in the sand east of Serdab No. 25.
34. FRAGMENT OF THE HEAD OF A LIMESTONE STATUETTE OF A MAN (Pl. XLI, 10). Height 13 cms. There was a plinth at the back of the figure. Found in the path leading to Serdab No. 13.

35. FRAGMENT OF THE LEFT ARM OF A LIMESTONE STATUE (Pl. XLI, 11). Height, 12 cms. At the back of the figure was a plinth. Found in the Brick Chamber behind Niche No. 14.
36. FRAGMENT OF THE CLOSED HAND OF A LIMESTONE STATUE (Pl. XLI, 12). Length, 8 cms. Found in the sand above Serdabs Nos. 17 and 18.
37. FRAGMENT OF THE RIGHT ARM OF A LIMESTONE STATUE (Pl. XLI, 13). Length, 26 cms. Found in front of the Rock Chamber.
38. FRAGMENT OF THE MIDDLE PART OF A LIMESTONE STATUETTE (Pl. XLI, 14). Height 17 cms. The right arm is bent, the hand placed on the left breast. Found in the sand in the southern part of the Tomb.
39. FRAGMENT OF THE RIGHT HAND AND ARM OF A LIMESTONE STATUE (Pl. XLI, 15). Length, 18 cms. Found in the sand.
40. FRAGMENT OF THE CLOSED HAND OF A STATUE (Pl. XLI, 16). Found in Serdab No. 2 (see p. 7).
41. FRAGMENT OF THE CLOSED HAND OF A STATUE (Pl. XLI, 17). Found in Niche No. 1. (see p. 7.)
42. FRAGMENT OF THE RIGHT HAND OF A LIMESTONE STATUE (Pl. XLI, 18). Length, 12 cms. Found in the sand.
43. FRAGMENT OF THE RIGHT HAND OF A LIMESTONE STATUE (Pl. XLI, 19). Length, 15 cms. Found in the sand.
44. FRAGMENT OF THE HAND OF A LIMESTONE STATUE (Pl. XLI, 20). Length, 8 cms. Found in the sand above Serdabs Nos. 17 and 18.
45. FRAGMENT OF THE RIGHT HAND OF A LIMESTONE STATUE (Pl. XLI, 21). Length 12 cms. Found in the sand.
46. FRAGMENT OF THE RIGHT HAND OF A LARGE LIMESTONE STATUE (Pl. XLI, 22.) Length, 15 cms. Found at the west side of the uninscribed Alabaster Altar.
47. FRAGMENT OF THE PEDESTAL OF A LIMESTONE STATUETTE (Pl. XLI, 23). Found in Niche 16, see p. 27.
48. FRAGMENT OF THE RIGHT FOOT OF A LIMESTONE STATUE (Pl. XLI, 24). Length, 10 cms. Found near Serdab No. 18.
49. THE LOWER PART OF A DOUBLE STATUETTE OF A MAN AND WOMAN SEATED ON A CHAIR (Pl. XLI, 25). Height, 21 cms. The male figure on the right has his hands resting on his thighs, palms downwards; the woman on his left is clad in a long close-fitting garment with her left hand resting on her left thigh. Found in the sand west of the roofed Serdab (S. 14).
50. FRAGMENT OF THE RIGHT HAND OF A LIMESTONE STATUE (Pl. XLI, 26). Length, 16 cms. Found in the southern part of the Tomb.

BURIALS IN AND AROUND THE TOMB OF RE^c-WER

SHAFT No. 1 (Fig. 27).

Shaft¹ 8.10 ms. deep. There is a recess cut on the eastern side 2.50 ms. from the ground level. The Sarcophagus Chamber is to the north of the bottom of the Shaft and on the west side of the chamber is a short narrow passage sloping upwards. Of the burial only a few bones were found scattered in the debris at the bottom of the pit and some bits of gold leaf. A pottery vase covered with a rough layer of plaster was found in the narrow passage.

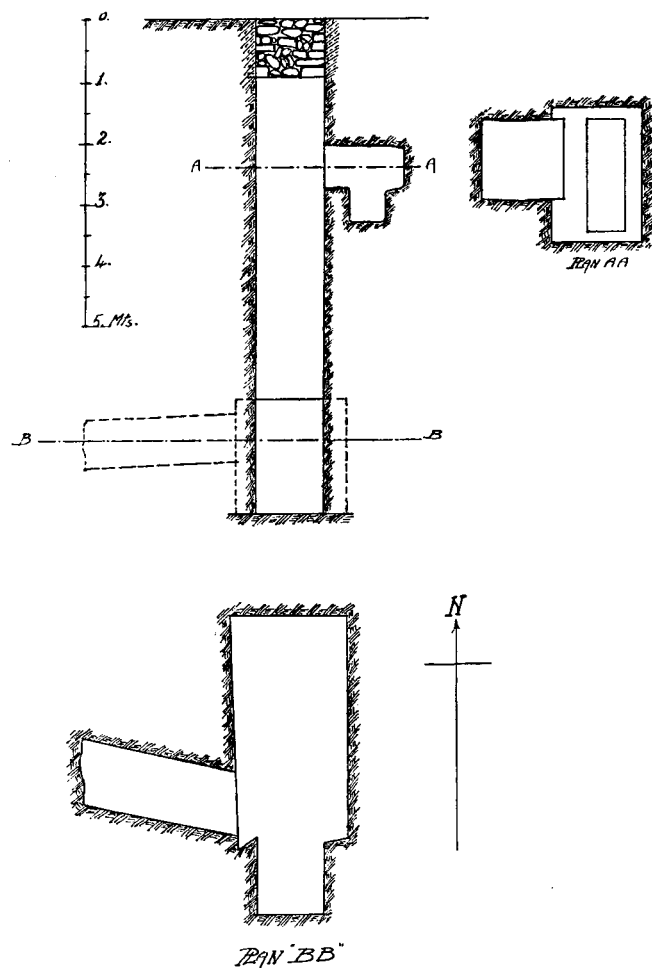

FIG. 27.

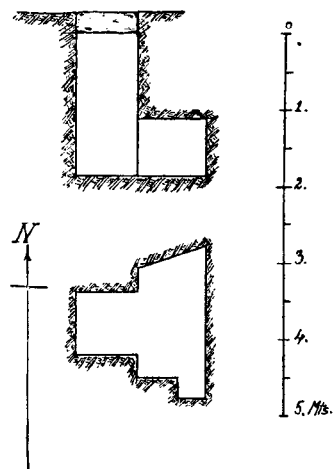

FIG. 28.

SHAFT No. 2. (Fig. 28).

Shaft 1.85 ms. deep with a small chamber at the bottom running east, the entrance to which was closed by two blocks of limestone. Burial: the skeleton of a female lying on her face, with head to the north.

¹ All the shafts described below are cut in the living rock.

SHAFT No. 16 (Fig. 29).

Shaft 5.80 ms. deep with recess on west side 1.90 ms. from the ground level. The Sarcophagus Chamber is to the west of the bottom of the pit with sarcophagus recess cut deep in the floor. The entrance was closed with two slabs of limestone and the sarcophagus recess with two large slabs. Burial: male skeleton with large head to north, lying on left side facing east. Contents, two shells (Pl. XXXV, 1) and a white pottery vase (Pl. XXXV, 2).

SHAFT No. 45 (Fig. 30).

Shaft 2.10 ms. deep, with small chamber on east side. The entrance to chamber was closed by three slabs of limestone. Burial: small skeleton of a man laid on left side, head north; hand lifted to front of face.

SHAFT No. 46. (Fig. 31).

Shaft 2.10 ms. deep, with small chamber on east side. The entrance to the chamber closed with pieces of limestone and mud. Burial: skeleton of an old man laid on left side, head north, face east.

SHAFT No. 47 (Fig. 32).

Shaft 2.10 ms. deep, with small chamber on east side. Entrance closed with one slab of limestone. Burial: male skeleton extended on left side with head resting on walls of north-western corner.

SHAFT No. 48 (Fig. 33).

Shaft 2 ms. deep, with chamber on east side. Entrance to chamber closed with limestone blocks and yellow clay. Burial: male skeleton lying on left side, head north and face east, in a rectangular sarcophagus cut in the floor of the chamber.

SHAFT No. 52 (Fig. 34).

Shaft 1.90 ms. deep, with unfinished chamber on east side. Burial: bones of a skeleton not intact.

SHAFT No. 53 (Fig. 35).

Shaft 2.10 ms. deep, with chamber on east side. Entrance closed with two slabs of limestone. Burial: female skeleton extended on left side with head resting on walls of the north-western corner.

SHAFT No. 54 (Fig. 36).

Shaft 2.35 ms. deep, with small chamber on east side. Burial: skeleton of a small man extended on left side, head north. The bones bear evidence of the man having suffered from arthritis.

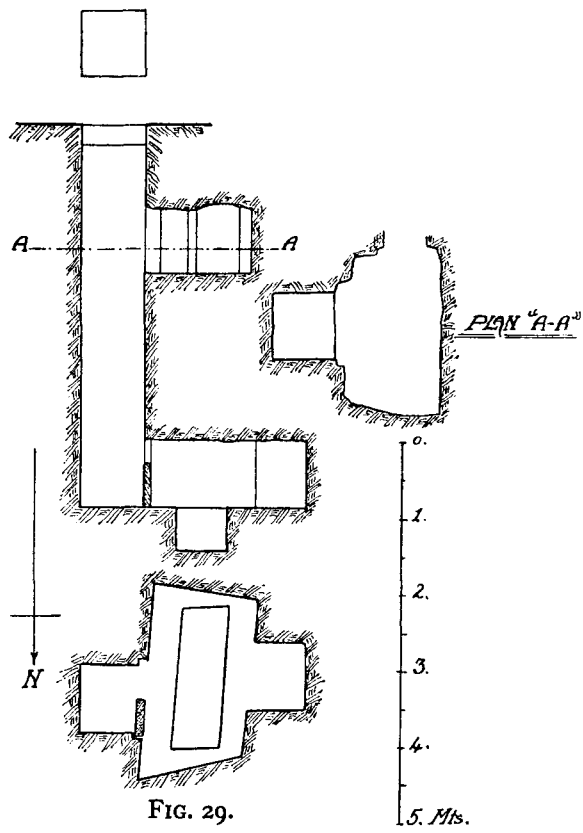

FIG. 29.

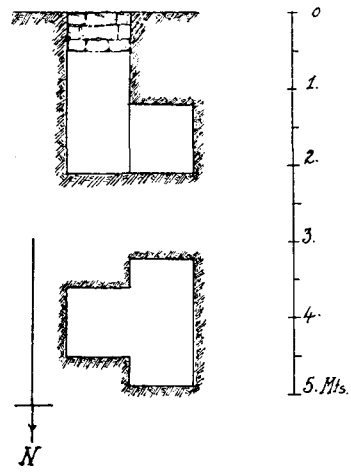

FIG. 30.

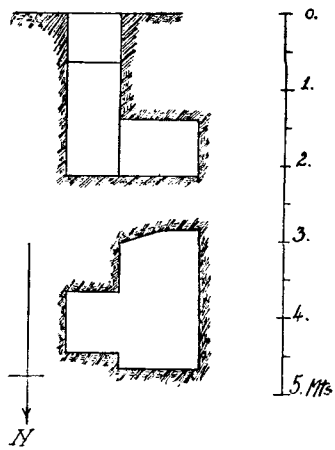

FIG. 31.

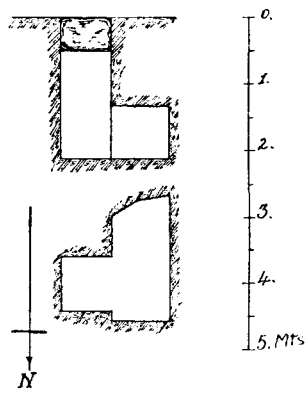

FIG. 32.

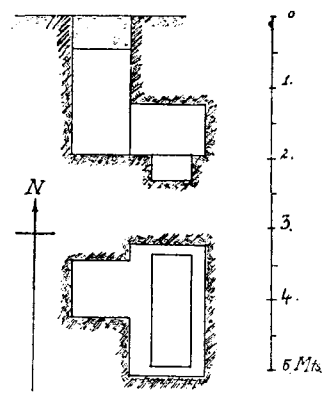

FIG. 33.

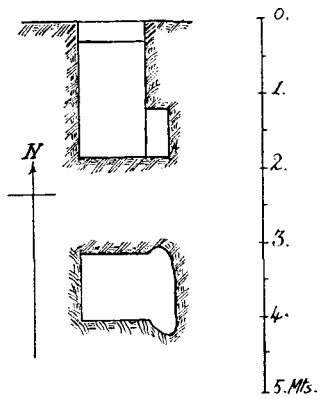

FIG. 34.

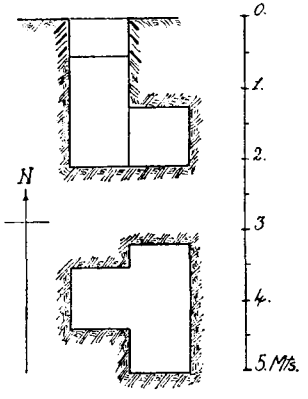

FIG. 35.

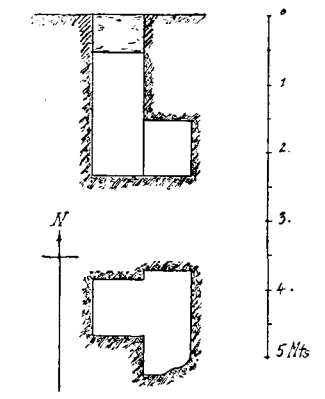

FIG. 36.

SHAFT No. 157 (Fig. 37).

Shaft 1.85 ms. deep, with small chamber on east side. Entrance closed with slabs of limestone. Burial: skeleton of man extended on left side, head north, in a rectangular sarcophagus cut in the rock-floor of the chamber.

SHAFT No. 159 (Fig. 38).

Shaft 4.70 ms. deep with chamber on east side. Entrance closed with one slab of limestone. Burial: bones of a skeleton not intact.

SHAFT No. 159 (Fig. 39).

Shaft 4.50 ms. deep with small chamber on east side. Burial: skeleton of a male extended on left side with head north.

SHAFT No. 135 (Fig. 40).

Shaft 1.85 ms. deep, with chamber on east side. The entrance closed with two slabs of limestone. Burial: skeleton of male contracted lying on left side with head north.

SHAFT No. 136 (Fig. 41).

Shaft 1.75 ms. deep, with chamber on east side. Entrance closed with a slab of limestone. Burial: skeleton of male contracted lying on left side with head north.

SHAFT No. 137 (Fig. 42).

Shaft 10.10 ms. deep, with chamber on south side. The upper part of the shaft surrounded by five courses of limestone blocks. The shaft is slightly deeper than the side chamber. Burial: skeleton of a middle-aged woman extended on left side with head north and surrounded with small slabs of limestone. The bones show evidence of the woman having suffered from arthritis.

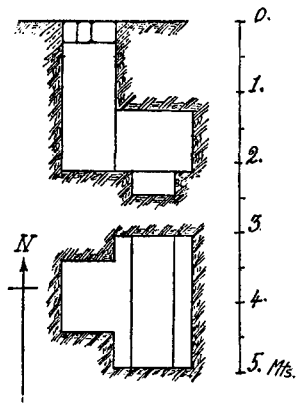

FIG. 37

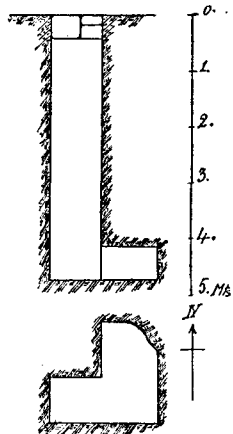

FIG. 38

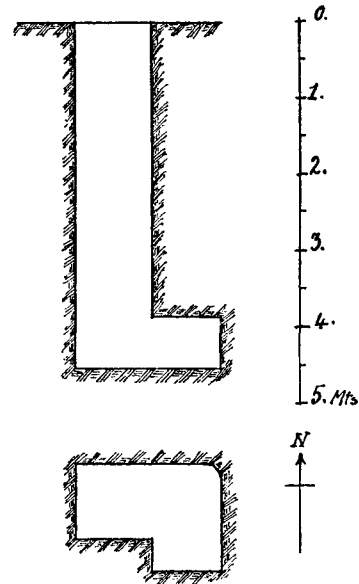

FIG. 39

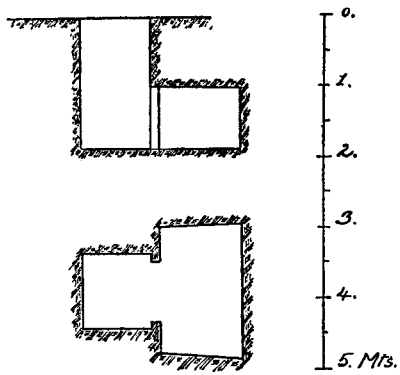

FIG. 40

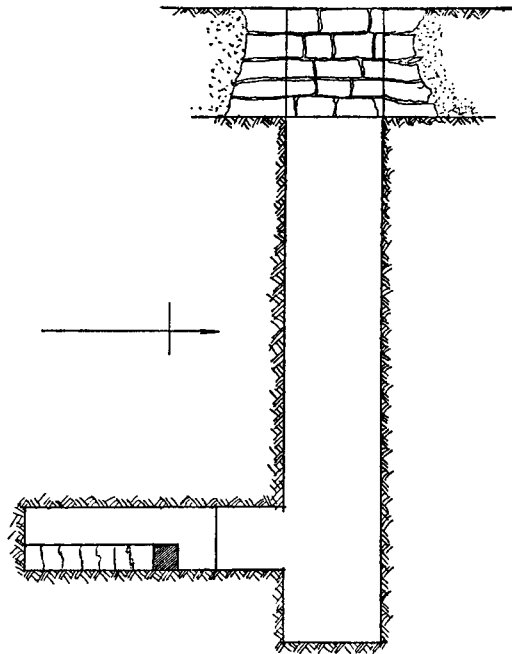

FIG. 42

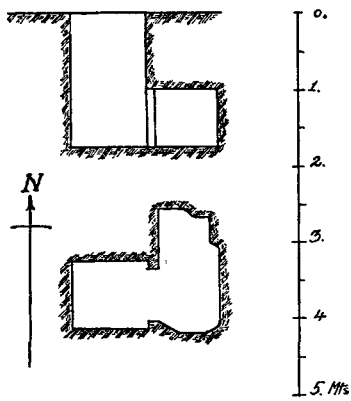

FIG. 41

SHAFT No. 133 (Fig. 43).

Shaft 14.75 ms. deep, with ten courses of crude brick at top, and rectangular chamber at bottom on south side. Burial: skeleton of a young female from 20 to 22 years of age lying on left side, head north, in a roughly cut limestone sarcophagus. On the skeleton were found necklaces, bracelets, and anklets. The necklaces were two in number (Pls. LXXVIII, LXXIX, 1) and consisted of strings of tubular beads of gold, lapis lazuli, and faience, with ~~~~~-shaped spacers of gold, and semicircular gold ends with gold wire string for tying. The bracelets and anklets are of similar form to the bracelets (Pl. LXXIX, 2 and 3), and composed of similar beads and spacers.

SHAFT No. 4 (Fig. 44).

Shaft 8.35 ms. deep with chamber at bottom on south side. The entrance to the chamber is a small doorway consisting of lintel and jambs in a wall built up of limestone blocks plastered over with clay. The walls of the chamber are covered with a coating of red plaster with traces of painting on the north side. Burial: a male skeleton, disturbed, lying in a rough rectangular sarcophagus cut in the native rock. Plundered in ancient times. Fragments of gold leaf.

SHAFT No. 10 (Fig. 45).

Shaft, 4.05 ms. deep, with small chamber at bottom on west side. Entrance closed with small stones plastered with yellow clay. Burial: skeleton extended on left side with head to the north.

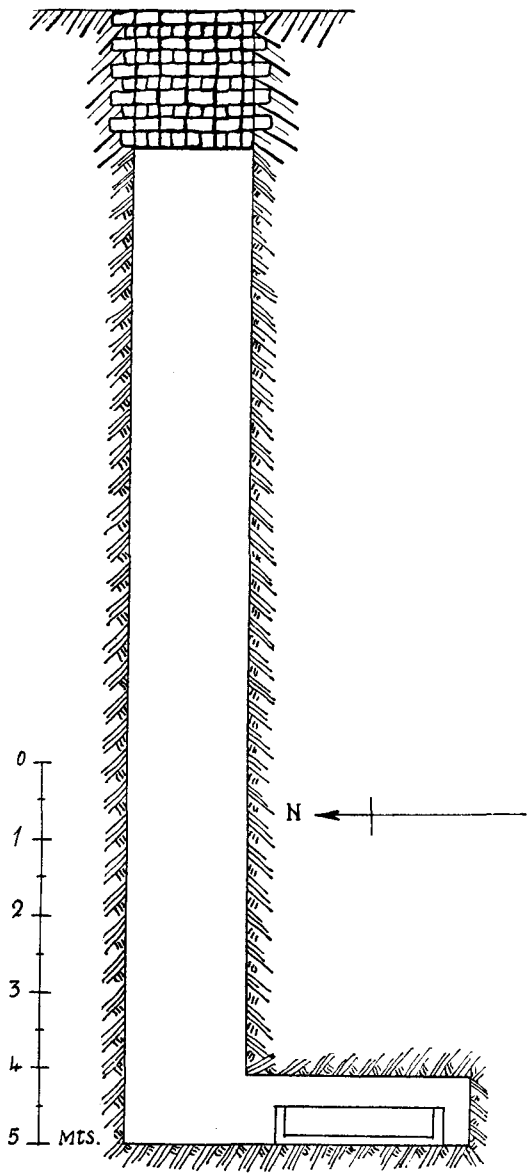

FIG. 43.

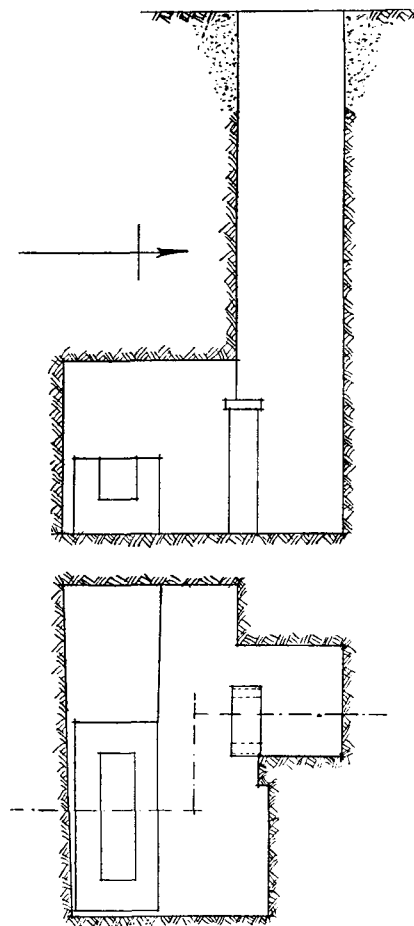
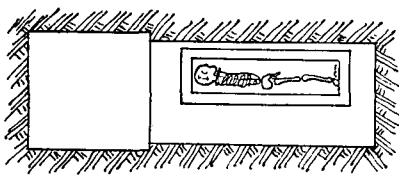

FIG. 44.

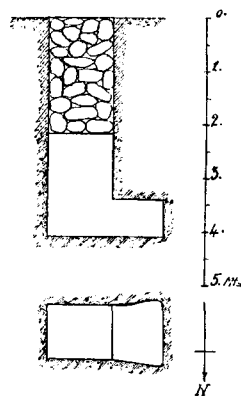

FIG. 45.

SHAFT No. 138 (Fig. 46).

Shaft 7.30 ms. deep, with chamber at bottom on west side. Entrance closed with two slabs of limestone. Burial: male skeleton extended on left side with head to the north.

SHAFT No. 12 (Fig. 47).

Shaft 2.20 ms. deep, with chamber at bottom on south side. Entrance closed with small blocks of stone plastered. Burial: disturbed skeleton lying on floor.

SHAFT No. 31 (Fig. 48).

Shaft 1.30 ms. deep. No chamber. Shaft filled with offering pots and saucers of red pottery.

SHAFT No. 41 (Fig. 49).

Shaft 2.50 ms. deep, with small chamber at bottom on east side. Burial disturbed, a few bones only being found in the debris.

SHAFT No. 40 (Fig. 50).

Shaft 4.90 ms. deep with chamber at bottom on east side. Entrance closed with small blocks of stone plastered over with yellow clay. Burial: skeleton lying on left side, in a recess cut in the floor.

SHAFT No. 39 (Fig. 51).

Shaft 6.40 ms. deep, with irregular chamber at bottom on west side. The entrance to the chamber was closed with two slabs of white limestone. In the debris of the shaft were found model loaves of bread in limestone (Pl. LXXVII, 2). Burial: male skeleton extended on left side with head to the north. Around the neck of the dead man was a necklace of 15 tubular faience beads (Pl. LXXVII, 3).

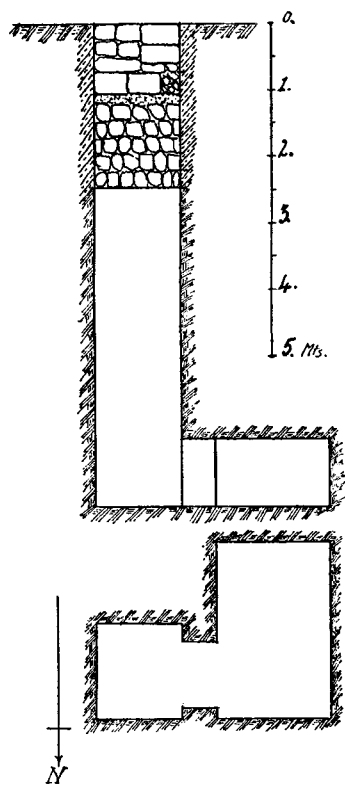

FIG. 46.

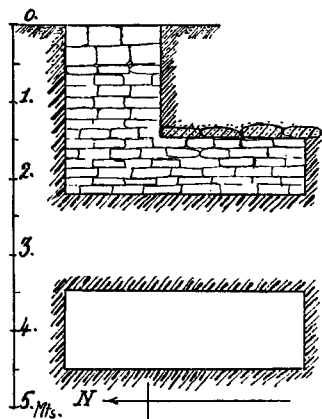

FIG. 47.

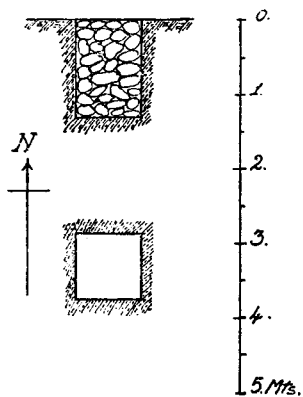

FIG. 48.

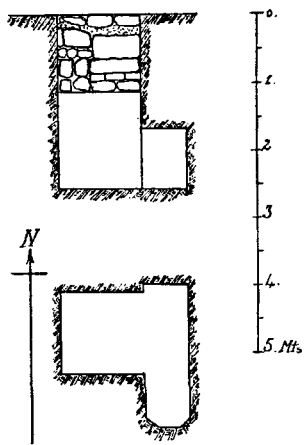

FIG. 49.

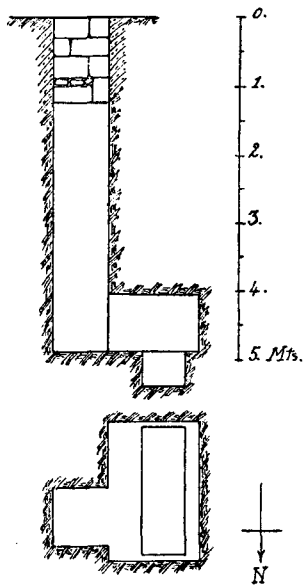

FIG. 50.

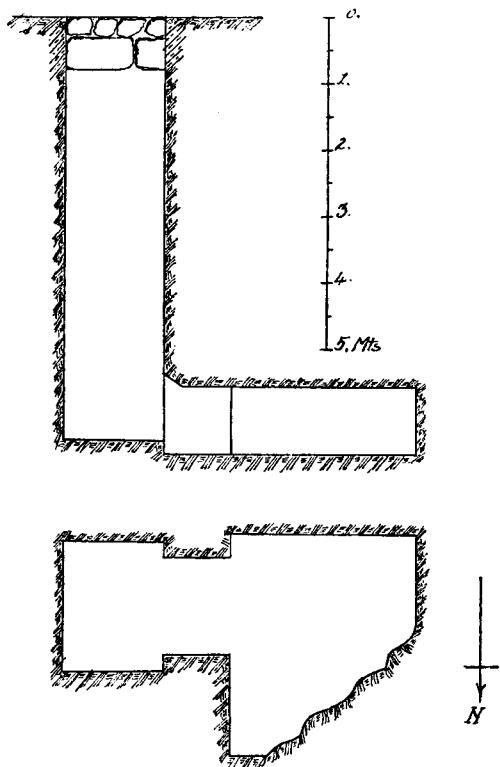

FIG. 51.

SHAFT No. 38 (Fig. 52).

Unfinished shaft 0.50 m. deep.

SHAFT No. 37 (Fig. 53).

Unfinished shaft with no burial, 1.80 ms. deep.

SHAFT No. 94 (Fig. 54).

Shaft 2.70 ms. deep with small chamber at bottom on east side. Entrance closed with small blocks of stone and clay. Burial: skeleton extended on left side with head to north in a recess cut in the floor of the chamber.

SHAFT No. 85 (Fig. 55).

Shaft 3 ms. deep with chamber at bottom on west side. Entrance closed with small blocks of stone and mud. Burial: a skeleton extended on left side with head north in a recess cut in the floor of the chamber.

SHAFT No. 147 (Fig. 56).

Unfinished shaft 1.40 ms. deep. No burial.

SHAFT No. 146 (Fig. 57).

Shaft 2.75 ms. deep, with small niche at bottom on east side. Contents: a few human bones scattered in the debris.

SHAFT No. 150 (Fig. 58).

Unfinished shaft 1.56 ms. deep. No burial.

SHAFT No. 151 (Fig. 59).

Shaft 6.20 ms. deep, with chamber at bottom on east side. Entrance closed with two slabs of limestone. Burial: male skeleton extended on left side with head to the north. Among the debris filling this shaft were found (1) a Statuette of *Rer-wer* (?) (see p. 20 and Pl. XXI), (2) a Triple Statuette of *Rer-wer* (p. 21, Pl. XXII), and (3) a Statuette of a man (Pl. LXXVI).

THE TOMB OF RE^c-WER

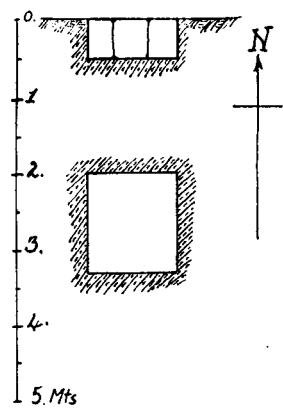

FIG. 52

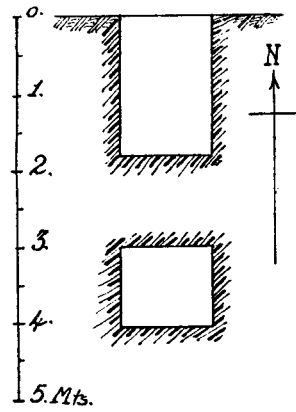

FIG. 53

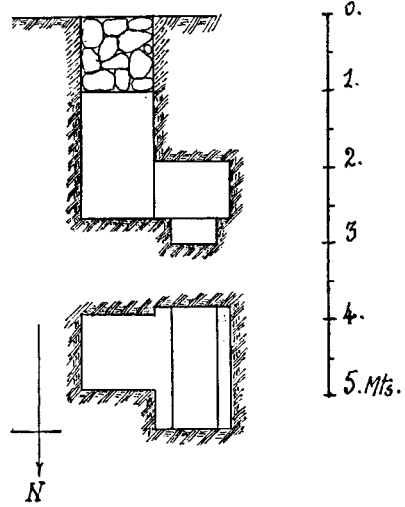

FIG. 54

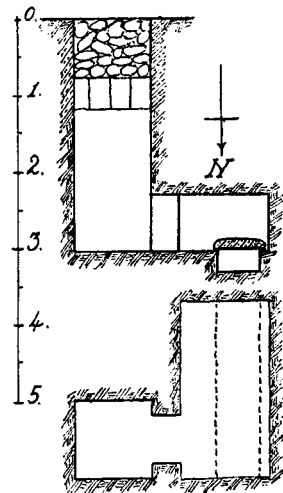

FIG. 55

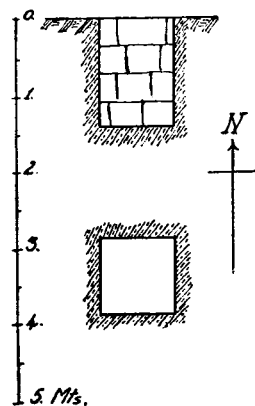

FIG. 56

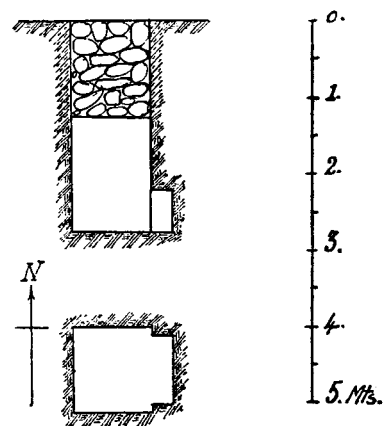
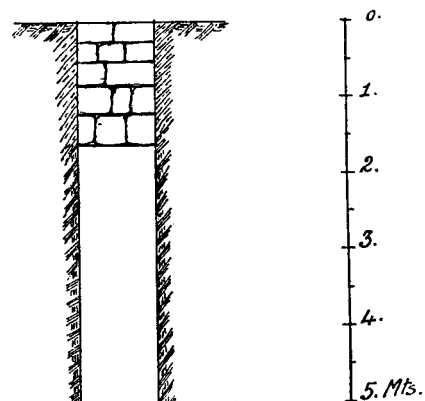

FIG. 57

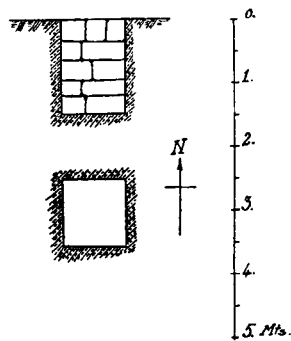

FIG. 58

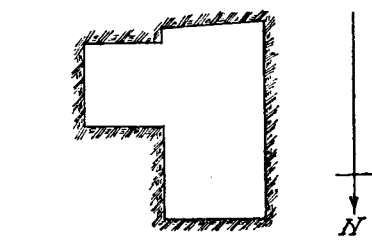

FIG. 59

H

SHAFT No. 152 (Fig. 60).

Unfinished shaft 2·47 ms. deep. No burial.

SHAFT No. 63 (Fig. 61).

Unfinished shaft 2 ms. deep. No burial.

SHAFT No. 64 (Fig. 62).

Shaft 2·45 ms. deep, with unfinished chamber at bottom on east side. Contents: a few scattered human bones in debris.

SHAFT No. 65 (Fig. 63).

Shaft 2 ms. deep, with chamber at bottom on west side. Entrance closed with small blocks of limestone and mud. Burial: a skeleton extended on left side with head to the north.

SHAFT No. 66 (Fig. 64).

Shaft 1·90 ms. deep, with unfinished chamber at bottom on east side. Contents: a few human bones scattered in the debris.

SHAFT No. 62 (Fig. 65).

Shaft 1·80 ms. deep, with small chamber at bottom on north side. Entrance closed with a slab of limestone. Burial: skeleton extended on left side with head to the north.

SHAFT No. 68 (Fig. 66).

Unfinished shaft 2 ms. deep. No burial.

SHAFT No. 69 (Fig. 67).

Unfinished shaft 1·40 ms. deep. No burial.

SHAFT No. 120 (Fig. 68).

Unfinished shaft 1·85 ms. deep. No burial.

SHAFT No. 70 (Fig. 69).

Shaft 1·30 ms. deep, with small chamber below on north side. Entrance closed with two slabs of limestone and yellow clay. Burial: skeleton extended on left side with head to the north.

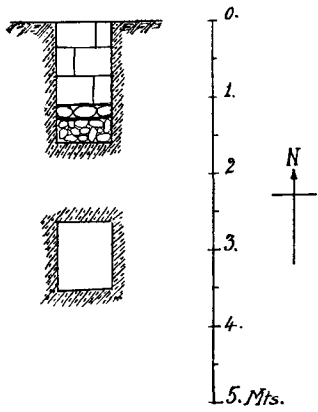

FIG. 60

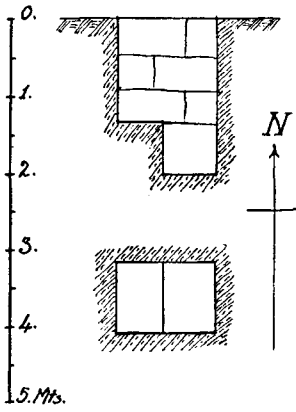

FIG. 61

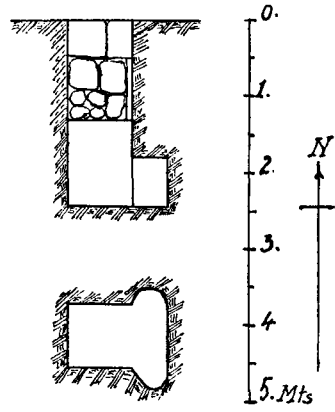

FIG. 62

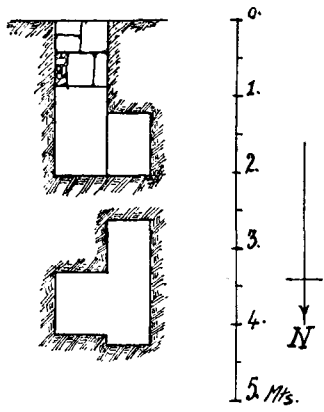

FIG. 63

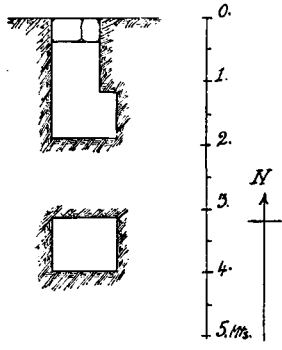

FIG. 64

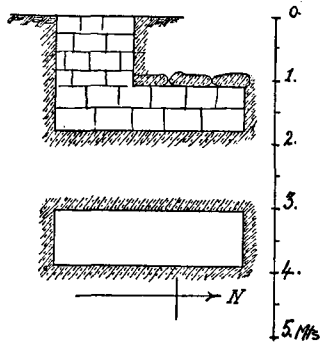

FIG. 65

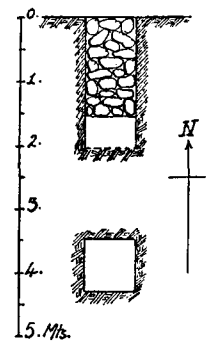

FIG. 66

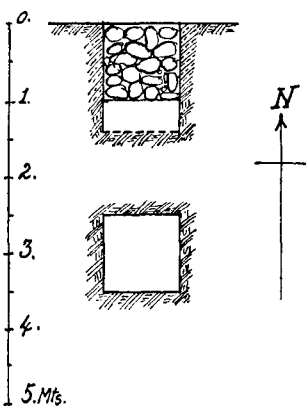

FIG. 67

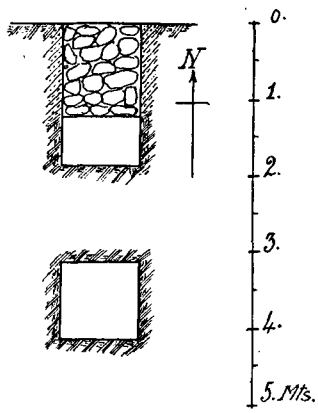

FIG. 68

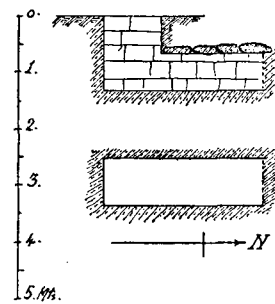

FIG. 69

SHAFT No. 55 (Fig. 70).

Shaft 4.10 ms. deep, with small chamber at bottom on west side. Burial: a few human bones scattered in the debris and a small piece of a copper nail.

SHAFT No. 56 (Fig. 71).

Shaft 3.50 ms. deep, with small unfinished recess at bottom on east side. Contents: a few scattered human bones in the debris.

SHAFT No. 57 (Fig. 72).

Shaft 4.35 ms. deep, with small unfinished chamber at bottom on west side. Burial: a few scattered human bones in the debris. In the filling of this shaft was found a broken statuette of a man standing with his right hand on his left shoulder (see Pl. LXXVII, 1).

SHAFT No. 118 (Fig. 73).

Shaft 3.45 ms. deep, with small chamber at bottom on west side. Entrance closed with three slabs of limestone. Burial: male skeleton contracted lying on left side with head to north and hands in front of face.

SHAFT No. 59 (Fig. 74).

Shaft 1.80 ms. deep, with small chamber at bottom on north side. Entrance closed with small blocks of stone and yellow mud. Burial: skeleton extended on left side with head north.

SHAFT No. 111 (Fig. 75).

Shaft 1.00 m. deep, with small chamber at bottom on south side. Entrance closed with small blocks of stone and yellow mud. Burial: a male skeleton contracted lying on left side with head north and hands in front of face.

SHAFT No. 114 (Fig. 76).

Shaft 2.79 ms. deep, with chamber at bottom on east side. Entrance closed with two slabs of limestone. Burial: skeleton of a man in contracted position lying on left side with head to north and hands in front of face.

SHAFT No. 112 (Fig. 77).

Unfinished shaft 1.90 ms. deep. No burial.

SHAFT No. 113 (Fig. 78).

Unfinished shaft 1.30 ms. deep. No burial.

SHAFT No. 30 (Fig. 79).

Shaft 1.40 deep, with chamber at bottom on south side. Entrance closed with small blocks of stone and yellow mud. Burial: a human skeleton in contracted position lying on left side with head north and hands in front of face.

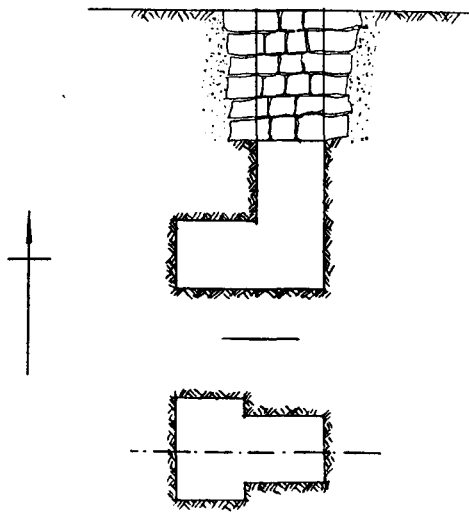

FIG. 70

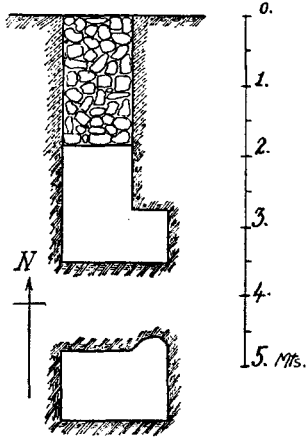

FIG. 71

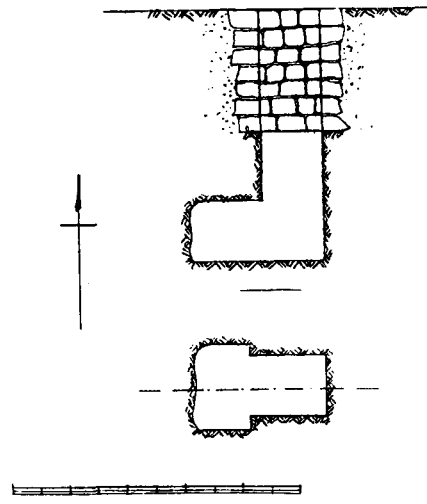

FIG. 72

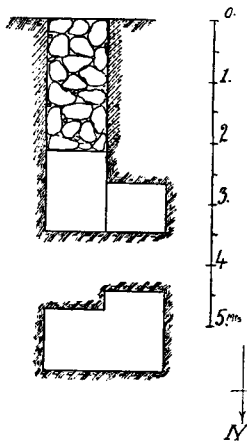

FIG. 73

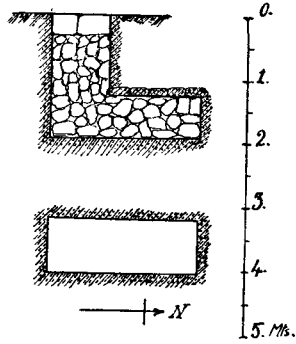

FIG. 74

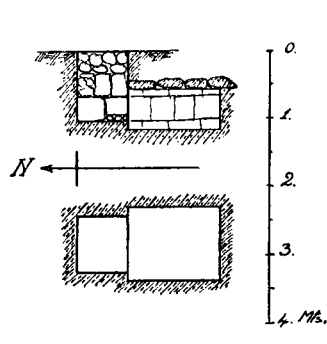

FIG. 75

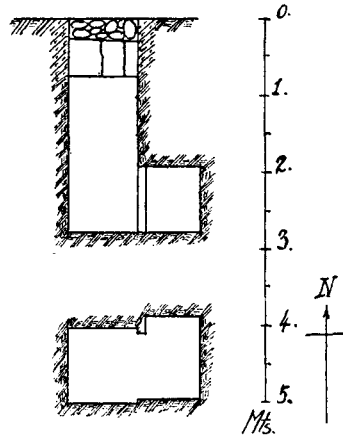

FIG. 76

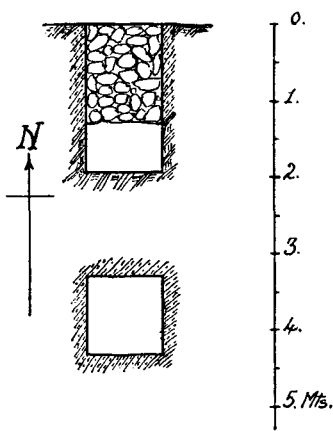

FIG. 77

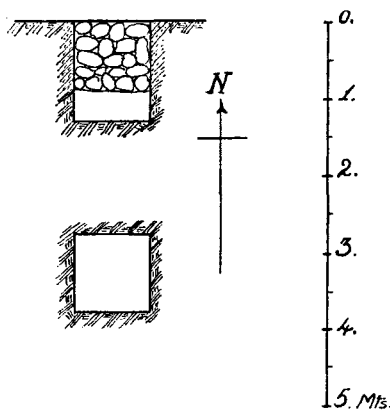

FIG. 78

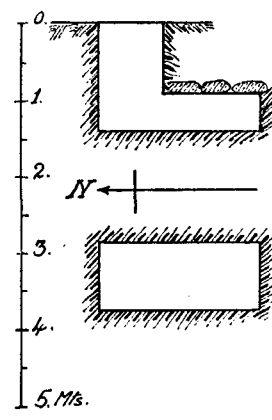

FIG. 79

SHAFT No. 29 (Fig. 80).

Shaft 2.10 ms. deep, with small chamber at bottom on south side. No burial.

SHAFT No. 28 (Fig. 81).

Shaft 1.20 ms. deep, with small chamber at bottom on north side. Burial: a human skeleton in contracted position lying on left side with head north and hands in front of face.

SHAFT No. 42 (Fig. 82).

Shaft 6.30 ms. deep, with chamber at bottom on west side. Entrance closed with large slab of limestone. Burial: male skeleton extended on left side with head to the north, lying in a rectangular recess cut deep in the floor of the chamber and covered with a large lid of limestone.

SHAFT No. 43 (Fig. 83).

Shaft 3.10 ms. deep, with small chamber at bottom on east side. Burial disturbed; only a few human bones were found scattered in the debris.

SHAFT No. 58 (Fig. 84).

Shaft 1.60 ms. deep, with small chamber at bottom on south side. Entrance closed with small blocks of stone and mud. Burial: skeleton extended on left side, head north.

SHAFT No. 101 (Fig. 85).

Unfinished shaft 1.60 ms. deep. No burial.

SHAFT No. 102 (Fig. 86).

Unfinished shaft 1.50 ms. deep. No burial.

SHAFT No. 103 (Fig. 87).

Shaft of uncertain depth, for the water level was reached at 8 ms. In the filling were found many fragments of red granite.

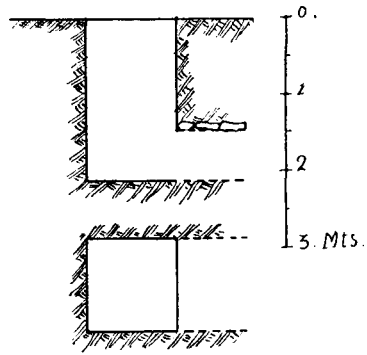

FIG. 80

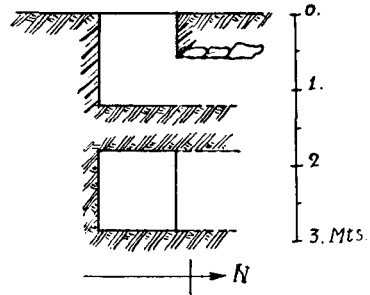

FIG. 81

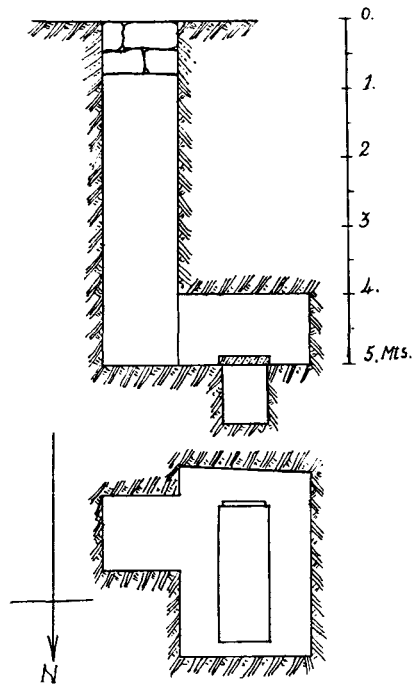

FIG. 82

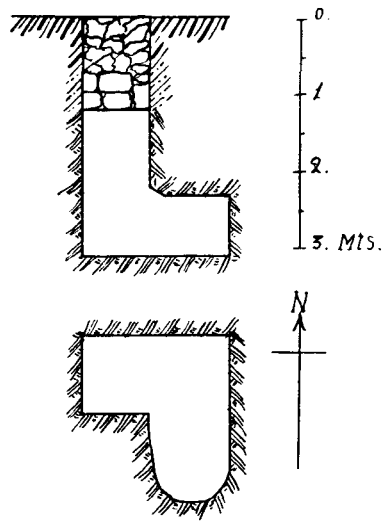

FIG. 83

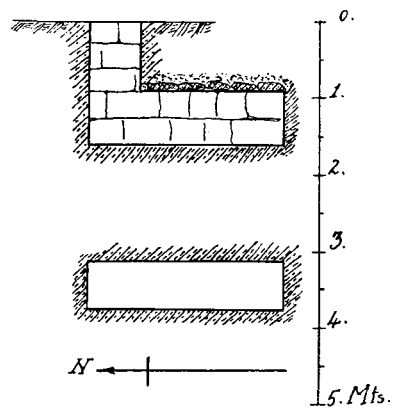
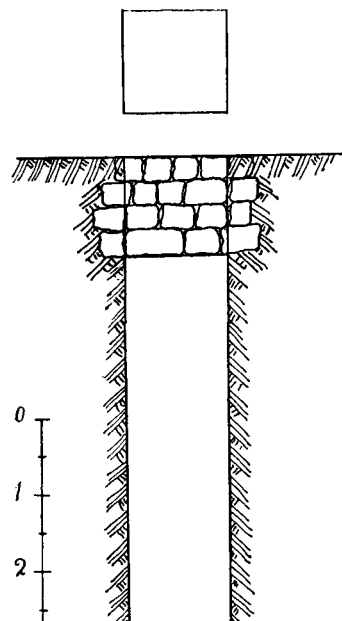

FIG. 84



SHAFT No. 104 (Fig. 88).

Shaft 3.95 ms. deep, with chamber at bottom on east side. Entrance closed with four blocks of limestone and yellow mud. Contents: a few scattered human bones were found in the recess cut in the floor of the chamber.

SHAFT No. 105 (Fig. 89).

Shaft 4.35 ms. deep, with a chamber at bottom on west side. Burial: a human skeleton extended on loose stones on floor of chamber.

SHAFT No. 106 (Fig. 90).

Unfinished shaft 1.60 ms. deep. No burial.

SHAFT No. 82 (Fig. 91).

Shaft 2 ms. deep, with unfinished chamber at bottom on east side. Burial: a human skeleton in contracted position lying on left side with head north.

SHAFT No. 83 (Fig. 92).

Unfinished shaft 1.10 ms. deep. No burial.

SHAFT No. 84 (Fig. 93).

Shaft 3.95 ms. deep, with chamber at bottom on south side. Entrance closed with small blocks of stone and yellow mud. Burial: skeleton extended on left side with head north.

SHAFT No. 73 (Fig. 94).

Shaft 5.05 ms. deep, with chamber at bottom on east side. Contents: a few human bones scattered in the debris.

SHAFT No. 74 (Fig. 95).

Shaft 3.80 ms. deep, with chamber at bottom on west side. Contents: a few human bones scattered among the debris.

SHAFT No. 72 (Fig. 96).

Shaft 1.50 ms. deep, with unfinished side chamber at bottom on west side. No burial.

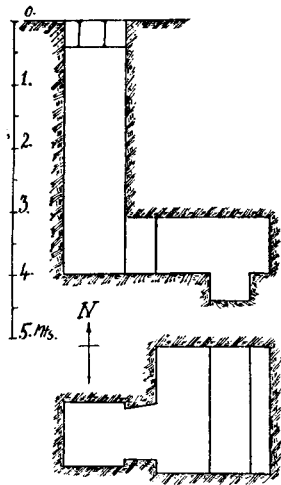

FIG. 88

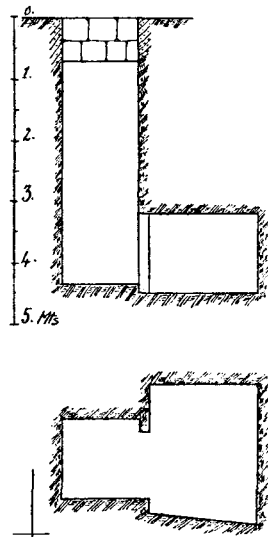

FIG. 89

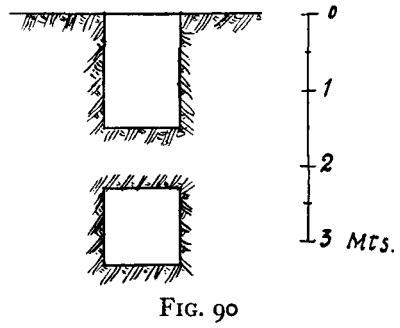

FIG. 90

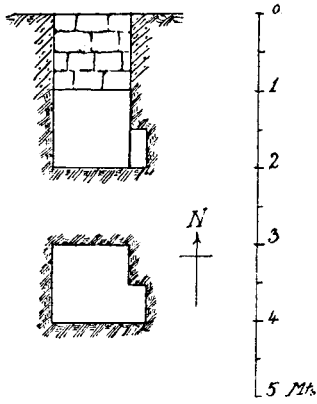

FIG. 91

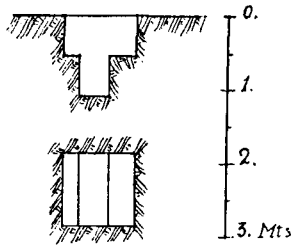

FIG. 92

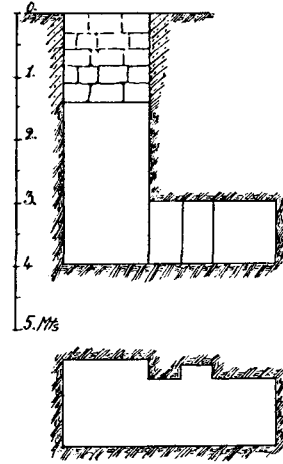

FIG. 93

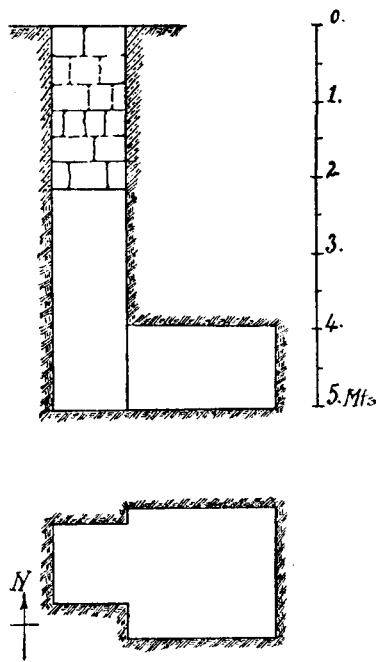

FIG. 94

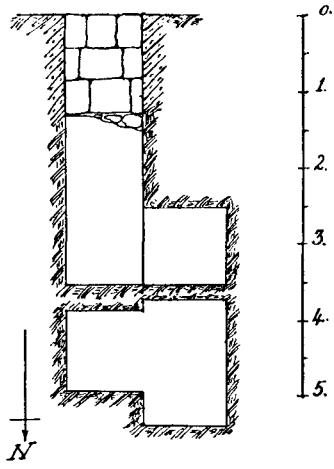

FIG. 95

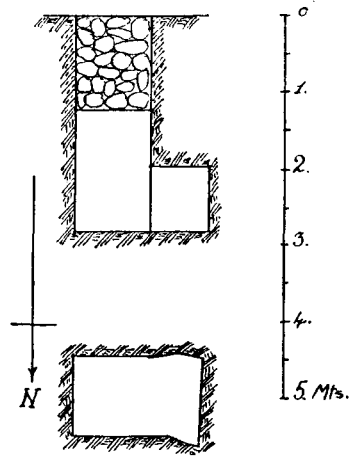

FIG. 96

SHAFT No. 116 (Fig. 97).

Unfinished shaft 1.60 ms. deep. No burial.

SHAFT No. 115 (Fig. 98).

Shaft 2.70 ms. deep, with small recess at bottom on east side. Burial: skeleton of a young child in contracted position, lying on left side with head north.

SHAFT No. 87 (Fig. 99).

Unfinished shaft 2.60 ms. deep. No chamber or burial.

SHAFT No. 77 (Fig. 100).

Shaft 2.55 ms. deep, with small chamber at bottom on east side. Entrance closed with two slabs of limestone and yellow mud. Burial: skeleton extended on left side with head to north.

SHAFT No. 78 (Fig. 101).

Shaft 4.60 ms. deep, with small chamber at bottom on south side. Entrance closed with three slabs of limestone. Burial: skeleton extended on back, head north, and face slightly turned to left.

SHAFT No. 79 (Fig. 102).

Shaft 3.50 ms. deep, with small unfinished recess in south side. Contents: a few human bones scattered in the debris.

SHAFT No. 125 (Fig. 103).

Shaft 1.83 ms. deep, with narrow chamber at bottom on north side. Entrance closed with small slabs of stone and yellow mud. Burial: a large skeleton extended on left side with head north.

SHAFT No. 98 (Fig. 104).

Shaft 2.80 ms. deep, with small chamber at bottom on west side. Entrance closed with a single slab of limestone. Deep rectangular recess sunk in floor of chamber. Burial: skeleton extended on left side, head north, and covered with a slab of limestone.

THE TOMB OF REU-WER

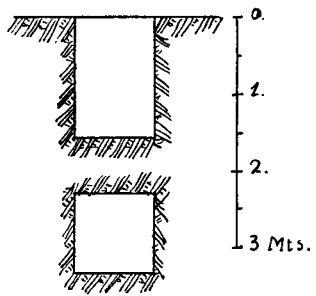

FIG. 97

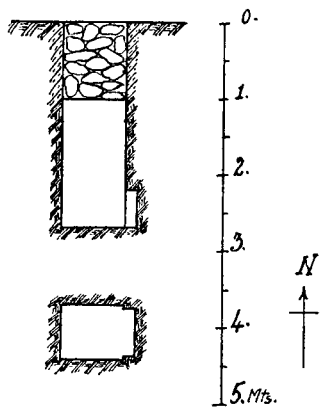

FIG. 98

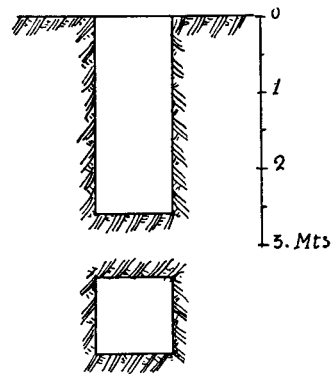

FIG. 99

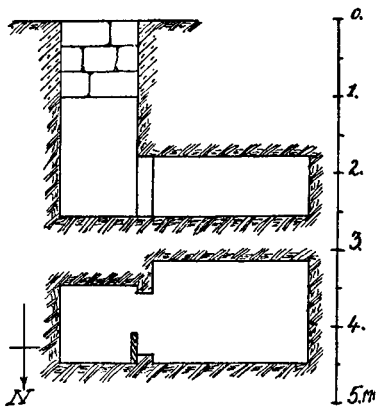

FIG. 100

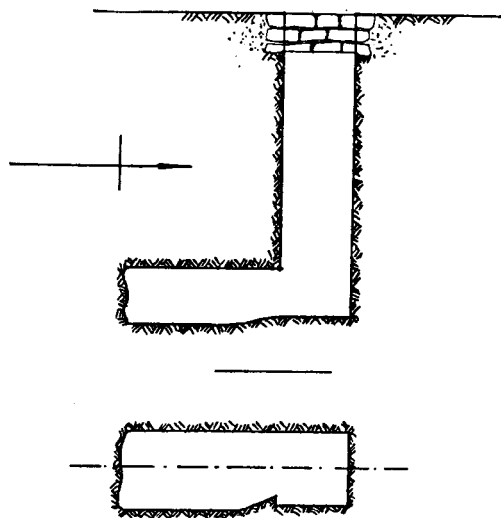

FIG. 101

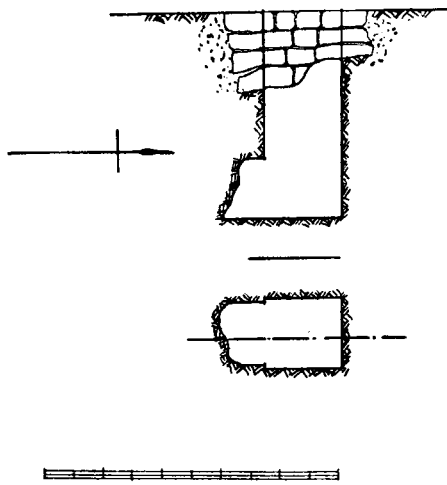

FIG. 102

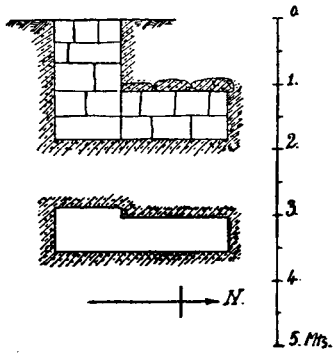

FIG. 103

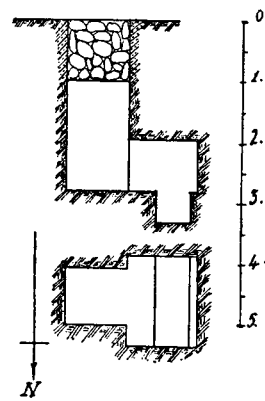

FIG. 104

SHAFT No. 99 (Fig. 105).

Unfinished shaft 1.80 ms. deep. No burial.

SHAFT No. 100 (Fig. 106).

Unfinished shaft 1.70 ms. deep. No burial.

SHAFT No. 161 (Fig. 107).

Unfinished shaft 3.50 ms. deep. No burial.

SHAFT No. 153 (Fig. 108).

Unfinished shaft 2.60 ms. deep. No burial.

SHAFT No. 160 (Fig. 109).

Shaft 4.30 ms. deep, with small chamber at bottom on south side. Entrance closed with small blocks of stone and yellow mud. Burial: skeleton in contracted position, lying on left side with head north.

SHAFT No. 130 (Fig. 110).

Unfinished shaft 2.75 ms. deep. No burial.

SHAFT No. 131 (Fig. 111).

Shaft 2.75 ms. deep, with small unfinished chamber at bottom on south side. Entrance closed with crude bricks. Burial: skeleton in contracted position, lying on left side with head to north.

SHAFT No. 132 (Fig. 112).

Shaft 1.65 ms. deep, with chamber at bottom on south side. Entrance closed with small blocks of stone and yellow mud. Burial: skeleton in contracted position, lying on left side, head to north.

SHAFT No. 154 (Fig. 113).

Shaft 1.85 ms. deep, with chamber at bottom on south side. Contents: a few scattered human bones among the debris.

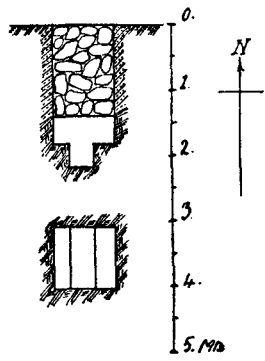

FIG. 105

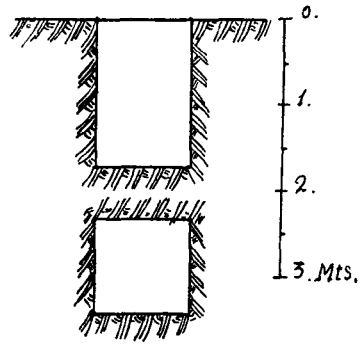

FIG. 106

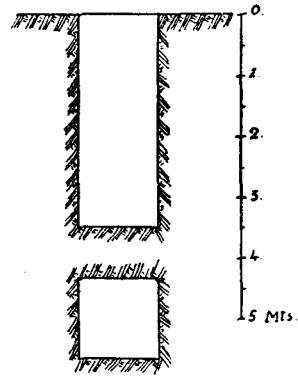

FIG. 107

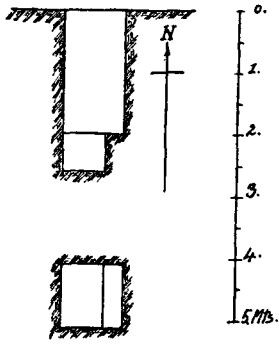

FIG. 108

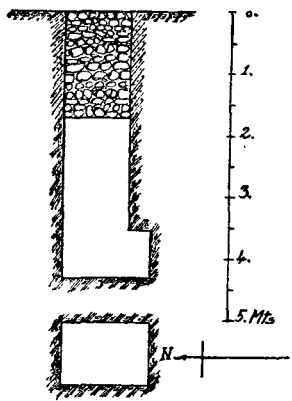

FIG. 109

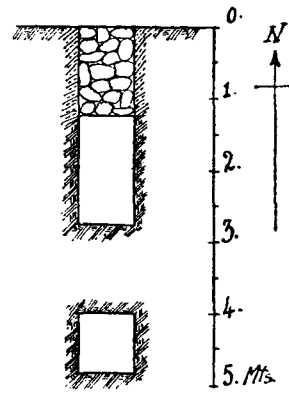

FIG. 110

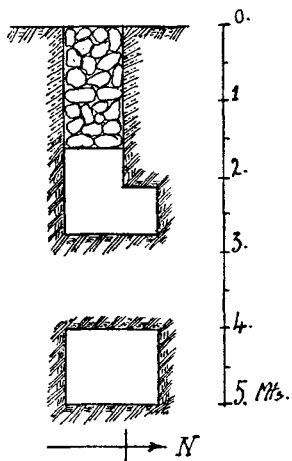

FIG. 111

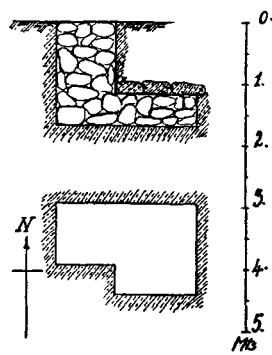

FIG. 112

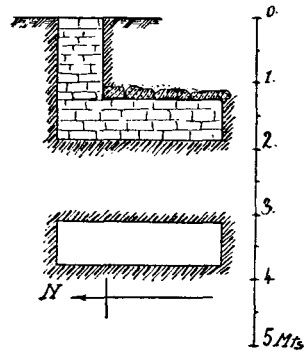

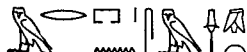

FIG. 113

THE MASTABAS

THE MASTABA OF MERUKA

TITLES OF MERUKA

1.  'The One Concerned with the King's Affairs'.
2.  'The Steward of the *Sem*-priest, The Director of the Kilt'.

THE Mastaba of Meruka is built against the northern end of the eastern wall of the Tomb of Re-*wer*; its northern limit is hidden below the brick Girdle-wall of the Sphinx. The façade, built of local limestone, faces east.

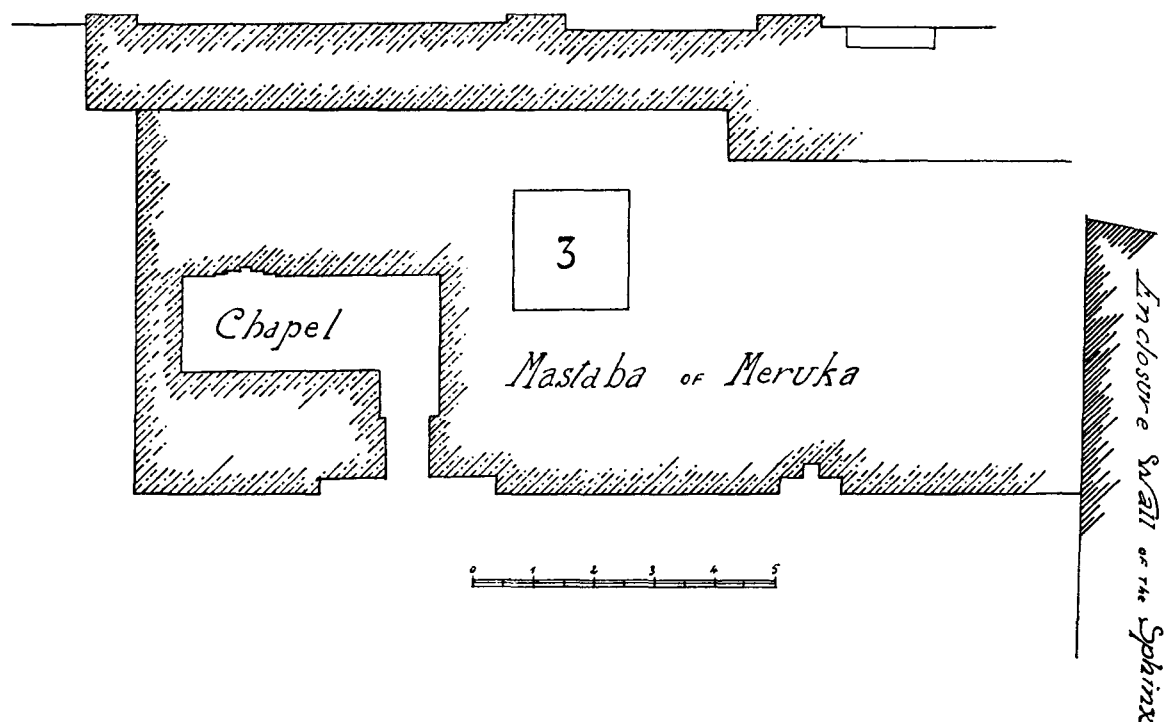

FIG. 114. Plan of the Mastaba of Meruka.

The entrance to the Mortuary Chapel is a narrow passage 65 cms. wide. The Chapel is a rectangular chamber constructed of white limestone slabs on a foundation of native rock and measures 4.20 ms. in length by 1.55 ms. broad, and 2.85 ms. high. It was roofed with large slabs of white limestone, each slab measuring 80 cms. by 25 cms. by 1.70 ms.; only two slabs still remain *in situ*. The walls of this Chapel are mostly destroyed, but at the southern end of the western one is a False-door of two slabs of stone without inscriptions. On the façade, at a distance of 4.75 ms. from the entrance, on its right-hand side, is another False-door, without inscriptions.

The Shaft of the Mastaba (fig. 114 A) is to the north of the Chapel; it is 7.50 ms. deep, with a sarcophagus chamber at bottom on the south side. This chamber measures 4.20 ms. by 2.65 ms., and in its floor is cut a rectangular recess which served as the sarcophagus; over the recess was

a large slab of limestone which served as a lid. Lying on the lid was the skeleton of a man, and in the recess below the lid was found a female skeleton lying on its left side with head to the north. Around the neck was a necklace (Pl. XLII, 1) of strings of beads of different kinds (650 gold and 2,000 steatite and lapis lazuli) with semicircular pieces of gold at the ends with gold wire tying strings. Four Canopic jars (Pl. XLII, 5) of white limestone, uninscribed, were found in the south-eastern corner of the Shaft, and in the filling of the Shaft were two fragments of an inscribed False-door (Pl. XLII, 2, 3, and 4) bearing the name of Meruka.

FALSE-DOOR OF MERUKA. The two fragments of the upper part of the False-door (Pl. XLII, 2 and 3) measure 50 cms. by 60 cms. by 16 cms. The outer jambs were inscribed with vertical columns of incised hieroglyphs reading $\leftarrow \downarrow$, $\downarrow \rightarrow$



The panel over the doorway is sculptured in relief with a figure of Meruka standing, holding in his right hand a long staff, and in his left the \downarrow -baton; before him are two vertical columns of hieroglyphs sculptured in relief reading $\downarrow \rightarrow$



Of the lintel of the false-door only the right-hand half is preserved; here Meruka is represented

seated before a table of offerings with his name $\downarrow \rightarrow$ in low relief in front of him. It is not certain whether the third fragment (Pl. XLII, 4) belongs to a false-door; more probably it is the end of a lintel from the tomb. On it is sculptured in relief, *en creux*, the figure of a woman seated upon a chair.

MASTABA OF ZEFA-NESUT

THIS Mastaba (see Pl. XLIII) is situated between the Tomb of Re-wer and the Mastaba of Kamnefert,¹ and is approached from the south by means of six descending steps cut in the native rock, which lead to a small opening (65 cms. by 90 cms.), giving access to a long narrow passage (9.00 ms. by 0.85 m.) with doorway to the Mastaba. The Mastaba itself is partly cut in the rock and partly built of local stone. On its façade were two false-door recesses. The doorway is 1.80 ms. high by 75 cms. wide; the door was of one leaf opening inwards with socket on eastern side. On the eastern jamb is incised a figure of Zefa-nesut (fig. 116) seated on a

¹ The Mastaba of Kamnefert will be published in the second report on the Giza Excavations.

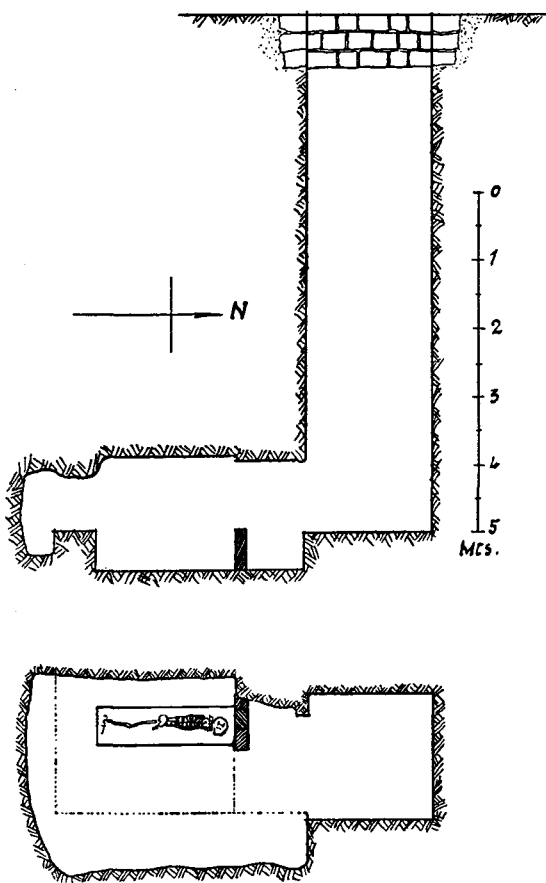

FIG. 114 A.

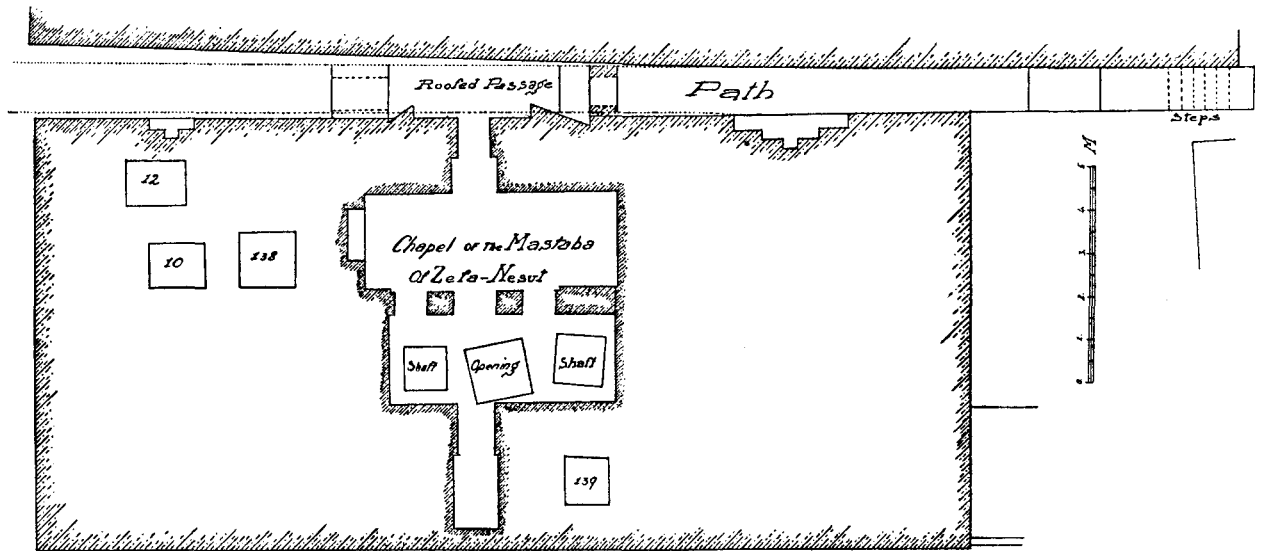

FIG. 115. Plan of the Mastaba of Zefa-Nesut.



FIG. 116. Figure of Zefa-Nesut.

chair, wearing a short wig, necklace, and loin-cloth; in his left hand he holds a long staff and the right hand rests upon his thigh. In front of him are two vertical lines of hieroglyphs reading $\leftarrow \downarrow$



The roofed passage to which the doorway gives access has three windows; one opens to the south, the second to the north, and the third, which is the largest of the three, opens to the east.

In the middle of the façade is the doorway to the Mortuary Chapel; this is cut in the native rock and measures 2.15 ms. high by 70 cms. wide. The Chapel is rectangular in plan, measures 6.10 ms. by 2.18 ms., and its roof was supported by two pillars square in section. In the northern wall is a large niche (1.15 ms. by 1.67 ms. by 0.50 m.) with two life-size Statues carved out of

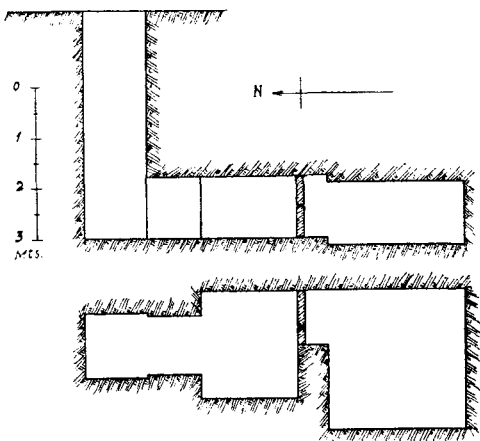

FIG. 117.

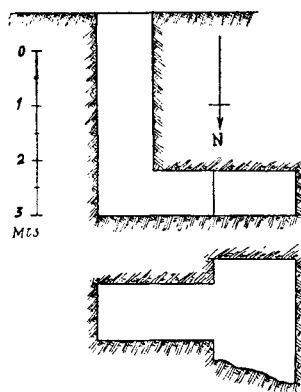

FIG. 118.

a single block of white limestone. This block has been broken in half and the left-hand piece with the figure of Zefa-nesut has fallen on to the ground; the right-hand piece still remains *in situ* and has on it the unfinished figure of a woman, probably Zefa-nesut's wife. The head and hands of Zefa-nesut's figure are missing. Near the south-western corner of the Chapel is an opening for light and in the inner wall is a long, narrow, unfinished chamber.

SHAFTS. There are two shafts cut in the rock floor of the Mortuary Chamber.

No. 1 (fig. 117). On the southern side of the Chamber; 3.90 ms. deep, with two sarcophagus chambers at the bottom on the south side. The filling of the shaft had been entirely removed and the chambers were both plundered in ancient times.

No. 2 (fig. 118). On the northern side of the Chamber; 3.80 ms. deep, with burial chamber at the bottom on the west side. Contents: a skeleton of a middle-aged man lying on the left side with head north.

STATUETTE of Zefa-nesut (?) (Pl. XLIV, 2). This Statuette is not inscribed but was found during the excavation of the tomb. It measures 28 cms. in height and the breadth across the chest is 10 cms. It represents a man seated on a stool and clothed in a short loin-cloth; he wears a short wig and broad necklace and bracelets. The left fore-arm, with hand open and palm downwards, rests upon the left thigh; the right fore-arm rests upon the right thigh and the right hand grasps the \square . The body is painted red, the nipples of the breast are black, and the stool is black; no colour remains on the necklace or bracelets.

hieroglyphs, reading . Adjacent to this False-door is a slab of local limestone, 0.60 m. by 1.20 ms. Here the owner of the mastaba is represented standing clad in a loin-cloth, facing south, and holding a long staff in his right hand. In front of him are two male children, one above the other, and both in a walking attitude; the lower figure holds the lower part of *Reḥ-wer*'s staff with his right hand.

FALSE-DOOR NO. 2 (see fig. 121, and Pl. XLIV) is composed of a single slab of local limestone broken near the middle into two parts; it measures 1.73 ms. by 66 cms. On the Panel (A) *Reḥ-wer* is represented standing facing ←, clad in a long cloth pointed in front,

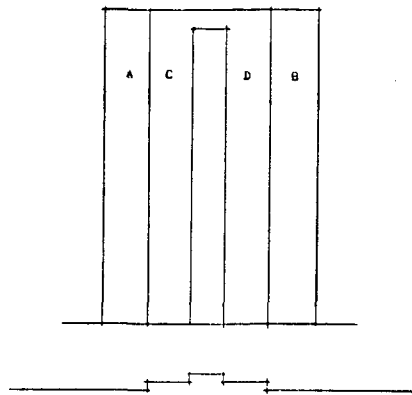

FIG. 120. False-door No. 1.

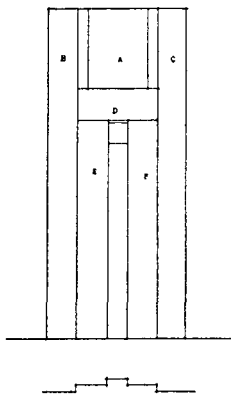

FIG. 121. False-door No. 2.

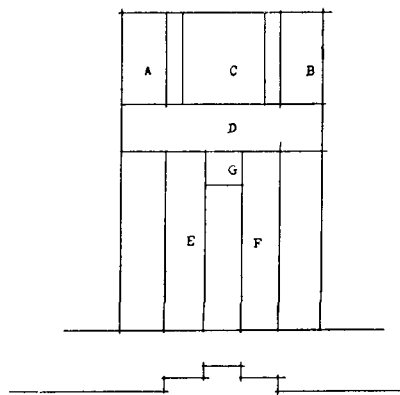





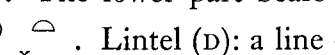
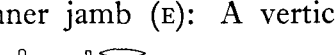
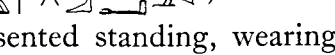
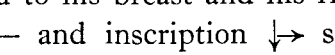





FIG. 122. False-door No. 3.

and holding in his right hand a long staff; the left arm hangs by his side with hand closed. Round his neck is a broad necklace. In front of him is a vertical column of hieroglyphs reading . The left-hand outer jamb (B) is divided vertically into five registers:— (1) A standing male figure, incised, with arms extended in an adoring attitude; above him is his name: . (2) A standing male figure, incised, nearly effaced, holding a long staff; above him is his name: . (3) A standing male figure, incised, of which only the legs are preserved. (4) A standing male figure, incised; the head and right arm are effaced, the left arm hangs at his side, above him was his name: . (5) A standing male figure now almost entirely effaced. The opposite right-hand jamb (C) is divided into two parts. The uppermost bears an incised column of hieroglyphs reading  with a standing figure of a man wearing a pointed kilt, incised, below. The lower part bears an incised column of hieroglyphs reading . Lintel (D): a line of incised hieroglyphs reading . Left-hand inner jamb (E): A vertical column of incised hieroglyphs reading ; below is a figure of *Reḥ-wer* → sculptured in relief *en creux*. He is represented standing, wearing short wig, necklace, and kilt pointed in front; his left hand is raised to his breast and his right arm hangs by his side. Right-hand inner jamb (F): A figure ← and inscription  similar to that on the left-hand jamb.

FALSE-DOOR NO. 3 (see fig. 122), of local limestone, measuring 1.05 ms. by 60 cms.; the lower

part is much damaged. On the Panel (c) Re \bar{c} -wer is represented seated on a chair with right arm resting on his thigh; his left hand is outstretched to a table of offerings in front of him. Under the table of offerings is incised . Above the offering-table in front of the seated figure is incised Re \bar{c} -wer's name and title: . On the left-hand jamb (A) is incised a vertical line of hieroglyphs reading . On the right-hand

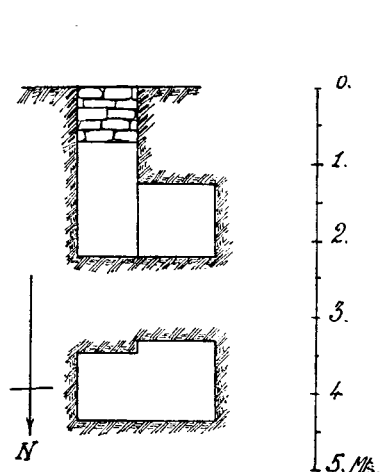

FIG. 123.

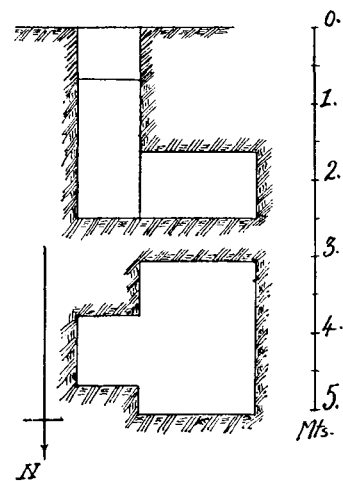

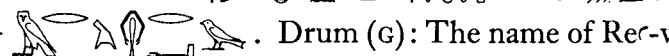





FIG. 124.

jamb (B) is an inscription reading . Lintel (D): A line of hieroglyphs reading . Drum (G): The name of Re \bar{c} -wer . On the inner jambs (E and F) Re \bar{c} -wer is represented in a walking attitude, with one hand raised to chest with hand closed; the other arm is broken away in both figures. Above the figures is Re \bar{c} -wer's name: .

SHAFTS. There are two Shafts in the Mastaba. NO. 140 (fig. 123) is 2.20 ms. deep, with a rectangular sarcophagus at bottom on the west side. Plundered in ancient times; contents, nil. NO. 141 (fig. 124) is 2.50 ms. deep, with a large rectangular sarcophagus chamber at bottom on west side. Plundered in ancient times; contents, nil.

MASTABA OF NEFER-WENT

TITLES OF NEFER-WENT

1.  'Inspector of the Department of the Domains of the Great House'.
2.  'Overseer of the Department of the Domains of the Great House'.

For Plan of the Mastaba, see p. 66, fig. 119.

THE Mastaba of Nefer-went is situated to the west of the Serdabs Nos. 10 and 11 of the Tomb of Re \bar{c} -wer, and to the north of the path leading to the Serdab No. 13 (see the General Plan). On the eastern face of the Mastaba, at a distance of 1.54 ms. from its southern end, is a small

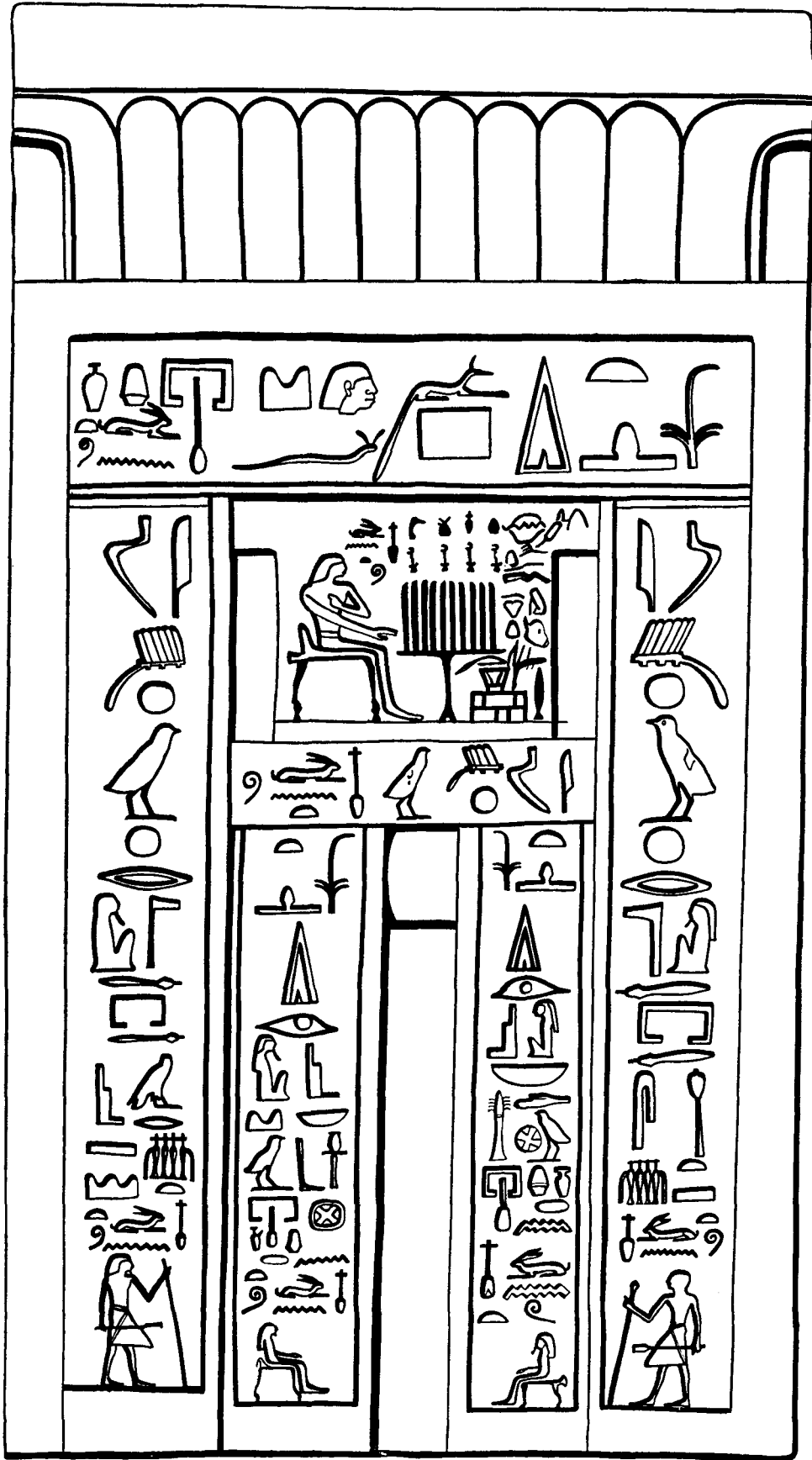

FIG. 125. False-door of Nefer-went.

recess with a small table for offerings in front of it; both recess and offering-table are much weathered. On the same wall, at a distance of 3.20 ms. from the recess is another, measuring 1.30 ms. by 0.72 m.; lying in front of it was found a False-door bearing the name of Nefer-went (Pl. XLIV, 3, and fig. 125). This False-door measures 88 cms. by 48 cms. by 13 cms. and is cut out of a single block of white limestone. At the top is a cavetto palm-leaf cornice with torus moulding below; this torus moulding runs down both sides of the False-door. On the outer lintel is an incised inscription reading $\leftarrow\downarrow$ 'A boon which the King gives, a boon which Anubis who presides over his mountain (gives), *pr-hrw*-offerings for (Nefer-)went'. On the left-hand outer jamb is an incised inscription reading $\leftarrow\downarrow$ 'The honoured one in the presence of the Great

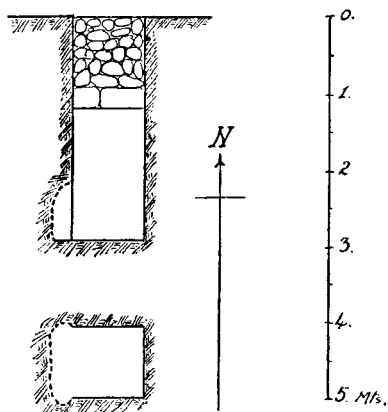

FIG. 126.

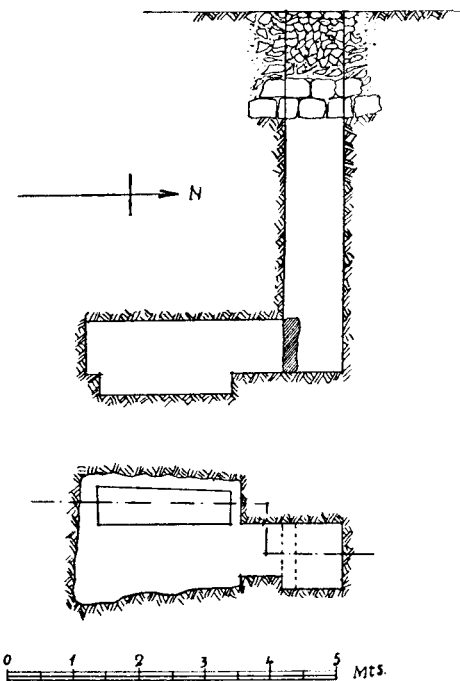

FIG. 127.

God, the Overseer of the landholders of the Great House, Nefer-went'. Below it is incised a standing figure of Nefer-went facing \rightarrow , wearing a long kilt pointed in front, and holding a long staff in one hand and a \uparrow -baton in the other hand. On the right-hand outer jamb the inscription reads $\downarrow\rightarrow$ 'The honoured one in the presence of the Great God, the inspector of the landholders of the Great House, Nefer-went'. Below is an incised figure of Nefer-went similar to that on the left-hand jamb but facing \leftarrow . On the panel below the outer lintel is an incised scene of Nefer-went seated facing \rightarrow before a table of offerings; above the table is an inscription reading 'A thousand loaves of bread, a thousand jars of beer, a thousand oxen, a thousand wild-fowl, Nefer-went'. Below this panel is the inner lintel of the False-door. On it is an inscription reading \leftarrow 'The honoured one Nefer-went'. On the inner jambs are also incised inscriptions; they read: Left $\leftarrow\downarrow$ 'A boon which the King gives, a boon which Osiris, Lord of Abydos (gives), *pr-hrw* offerings for Nefer-went'. Right $\downarrow\rightarrow$ 'A boon which the King gives, a boon which Osiris, Lord of Dedu (gives), *pr-hrw* offerings for Nefer-went'. Below this False-door, in the pathway separating the Tomb of Re \bar{c} -wer from the Mastaba of Nefer-went, was

found the skeleton of a child about five years of age. Around the child's neck was a necklace (Pl. XLV) consisting of blue faience beads, 19 star-shaped, one disk-shaped, and 85 circular. This burial probably belongs to the Middle Kingdom.

SHAFTS. Shaft No. 91 (fig. 126), 2.80 ms. deep, with an unfinished chamber cut at the bottom at the west side. Plundered in ancient times. In the filling of the shaft was found the head of a statuette of *Re-r-wer* (see p. 20).

Shaft No. 92 (fig. 127), 5.50 ms. deep, with a sarcophagus chamber 3.20 ms. by 2.00 ms., cut at the bottom on the south side. In the floor is sunk a rectangular recess in which was found the skeleton of a full-grown man, 1.85 ms. tall, lying on his left side, facing east, with head to the north.

THE MASTABA OF SHAFT No. 35

THIS Mastaba (fig. 128) is built of coarse local limestone and measures 24 ms. by 12.75 ms. Its western side abuts on to Serdab No. 14 of the Tomb of *Re-r-wer*, and its southern end on to the

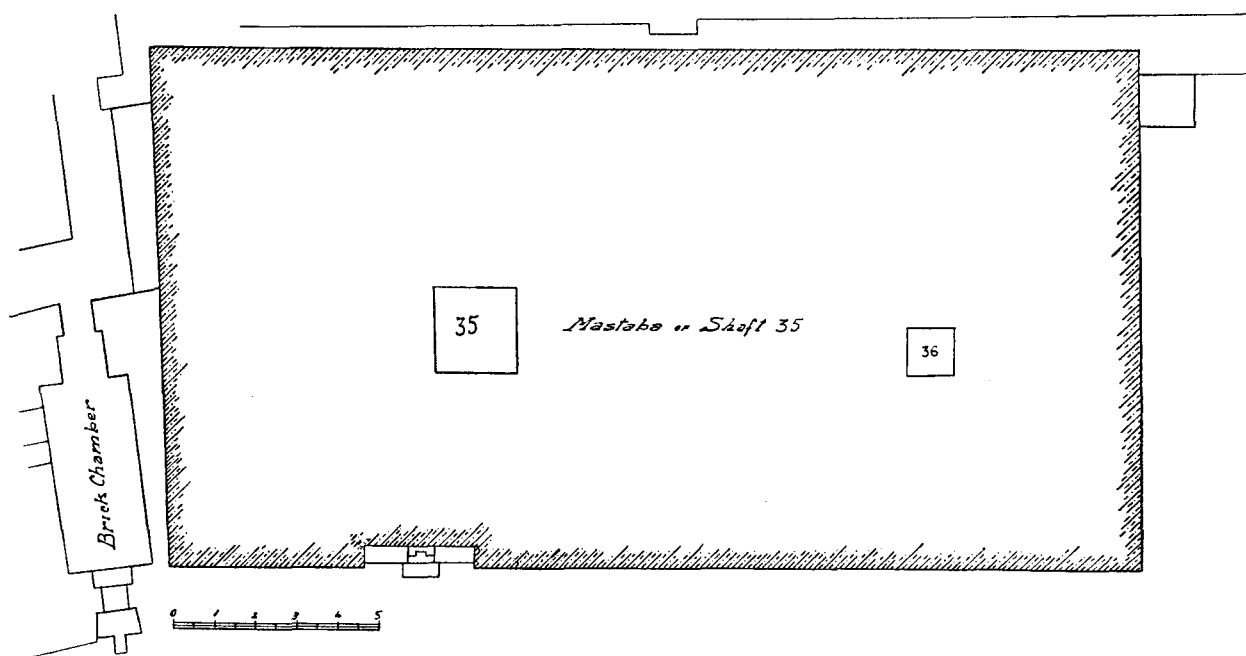



FIG. 128. Plan of the Mastaba of Shaft No. 35.

Brick Chamber with Alabaster Panel of the same tomb. In the eastern façade of the Mastaba was a large uninscribed False-door in front of which was found a large pottery altar-pedestal (Pl. LXXX, B, 2). There is no Mortuary Chapel to this Mastaba.

SHAFTS. SHAFT NO. 35 (fig. 129) is 13.60 ms. deep, with a rectangular sarcophagus at bottom on the south side; this chamber is filled with water. In the filling of the shaft were found:—

1. The lower part of a chair of a limestone Statuette of *Re-r-wer*. Two more pieces of the same Statuette were found in Shaft No. 161 during the excavations of 1930-1931 (Pl. XLVI, 2). On either side of the legs of *Re-r-wer* is a vertical column of hieroglyphs reading ←↓, ↓→



2. The head and torso of a Statuette (Pl. XLVI, 3 and 4), and a hand of a red granite Statuette.
 3. The pedestal with feet of a Sandstone Statue (Pl. XLVI, 5). On the front of the pedestal is incised a horizontal line of hieroglyphs giving a name and titles:— .
 'The Doctor, Overseer of the Scribes, Wer-khuu'.

SHAFT NO. 36. The opening to this Shaft is 1.30 ms. square and it is 2.10 ms. deep; it is unfinished and there is no sarcophagus chamber. In the filling of it was found a crouching Statuette (Pl. XLVI, 1) in white limestone. The head, right arm, both hands and left foot have been broken off and are missing. Another piece of the pedestal of the same Statuette with the right thigh, leg and foot, was found in the season 1930-1931 in the debris to the east of the Mastaba.

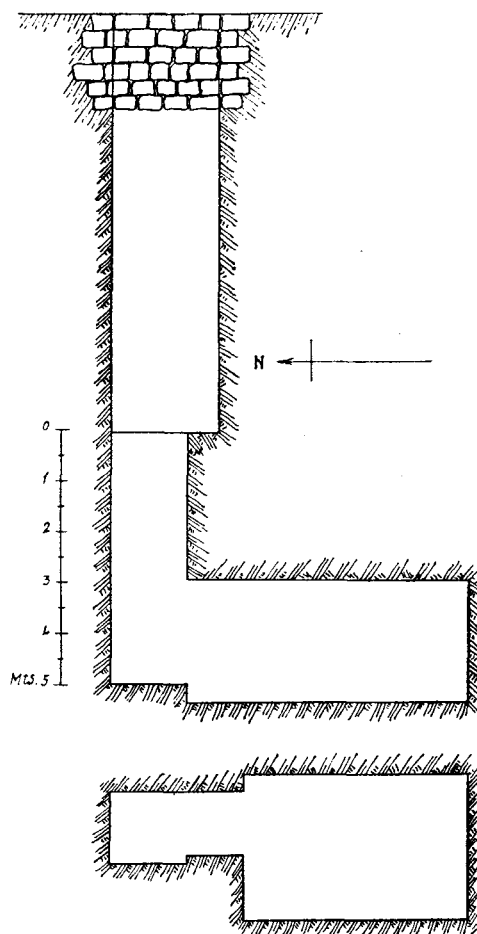

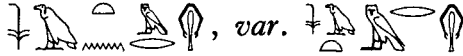



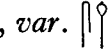

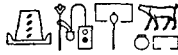

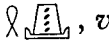
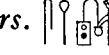
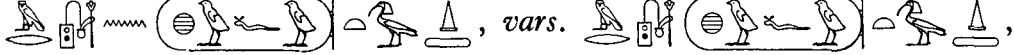







FIG. 129. Plan and Section of the Shaft No. 35.

MASTABA OF  AKHET-HETEP

TITLES OF AKHET-HETEP

1.  'He who is concerned with the King's Affairs'.
2. , *var.*  'The Overseer of the *Ka*-Servants of the King's Mother'.
3.  'The Scribe of the Treasury'.
4. , *var.*  'Inspector of the Scribes of the Treasury'.
5.  'Scribe of the Granary of the Treasury'.
6.  'Scribe of the Granary of the Treasury of the Palace'.
7. , *vars.* ,  'Inspector of the Scribes of the Granary'.
8. , *vars.* , ,
 'Overseer of the Scribes of the Pyramid (named) Khufu-Akhet'.

FAMILY OF AKHET-HETEP

Father (?)  Kanefer, with title  'He who is concerned with the Affairs of the King'.

Mother (?)  Peseshet, with the titles  'Overseer of the Physicians' and  'Ka-servant'.

Wife.  Nekau-Hathor, with the titles  'She who is concerned with the Affairs of the King', and  'Ka-servant of the King's Mother'.

Eldest son.  Hamuka.

Eldest Daughter.  Nefret.

Son.  Reo-wer.

Priests. (1)  'The *Ka*-servant Herunefer'.

(2)  'The *Ka*-servant Ka-iy'.

(3)  'The *Ka*-servant of the . . . house, Hernefret'.

THIS Mastaba is situated to the south of the tomb of Reo-wer and east of the rock-cut mastaba (see Plan, fig. 130). It is partly excavated in the living rock and its upper part is completed by several courses of local stone blocks. The doorway giving access to the chapel faces to the east

(dimensions 2.26 ms. high by 0.78 m. wide). The lintel is of Turah limestone inscribed with two horizontal rows of hieroglyphs finely cut (fig. 132).

The outer faces of the jambs are plain but figures of the deceased are cut in sunk relief on their

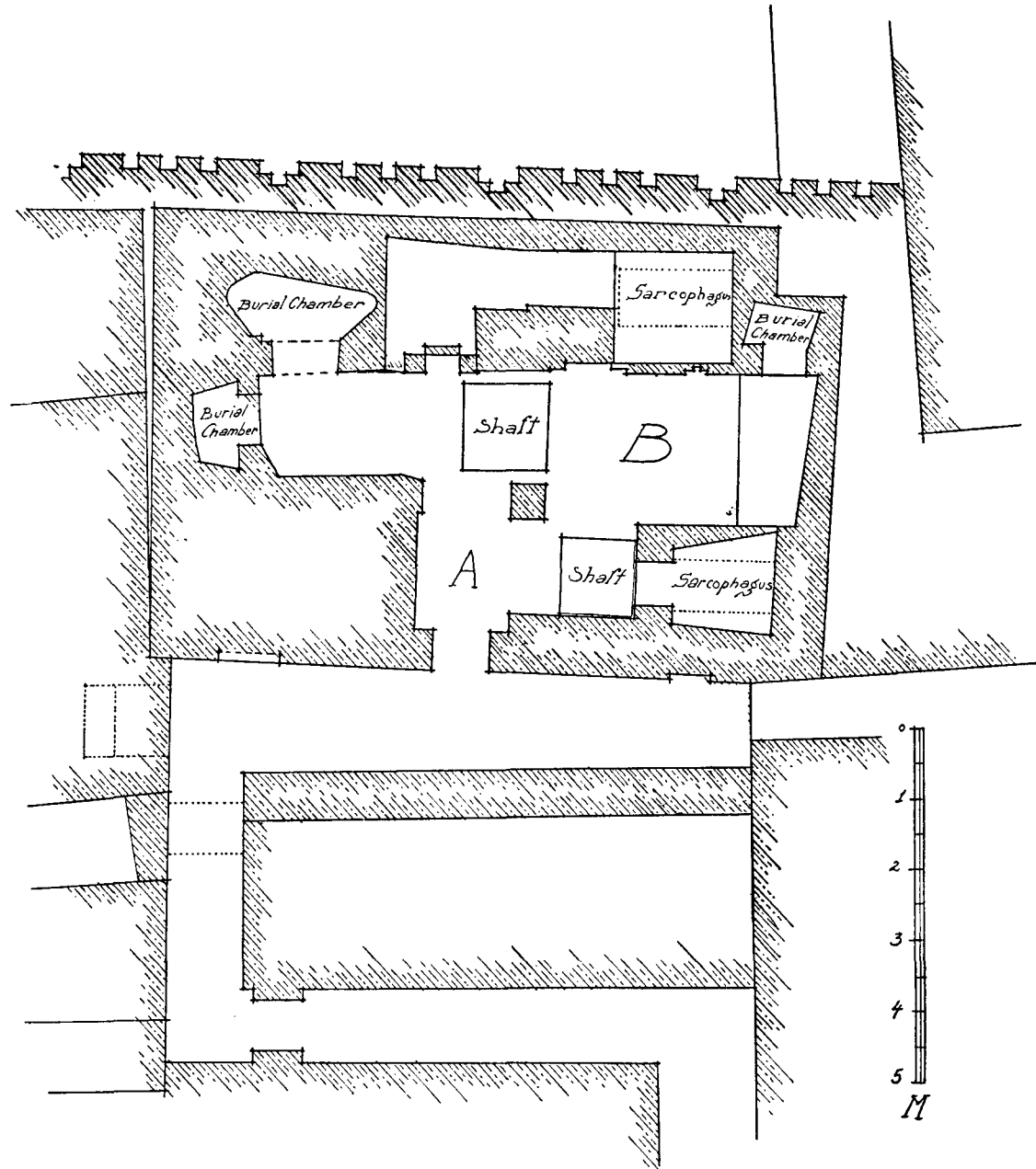

FIG. 130. Plan of Mastaba of Akhet-hetep.

thicknesses. On the left hand Akhet-hetep (Pl. XLVII and fig. 133) is represented seated on a chair holding a long staff in his right hand; he wears a wig, necklace, and short kilt crimped on one side. Above him are two vertical columns of hieroglyphs giving his name and titles. Behind him stands his eldest son Hemuka whose right hand rests on the back of his father's chair. Hemuka wears a necklace but is otherwise nude, and from the left side of his head hangs the long lock of hair typical of a youth. Above him is a vertical column of hieroglyphs reading

'His (i.e. Akhet-hetep's) eldest son, Hemuka'. On the right-hand jamb-thickness is a similar scene (Pl. XLVII and fig. 134) representing Akhet-hetep seated; above him are two vertical columns of hieroglyphs giving his name and titles, and behind him stands his daughter Nefret whose left hand is raised to her breast, the right arm hanging down by her side.

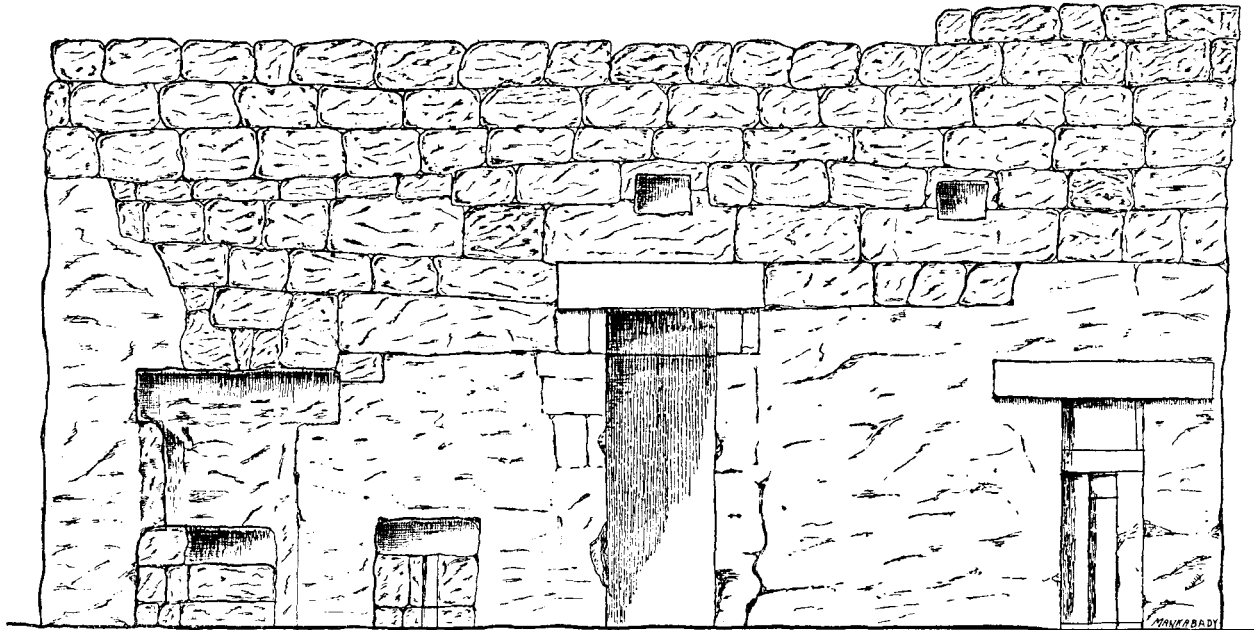

FIG. 131. Façade of Mastaba of Akhet-hetep.

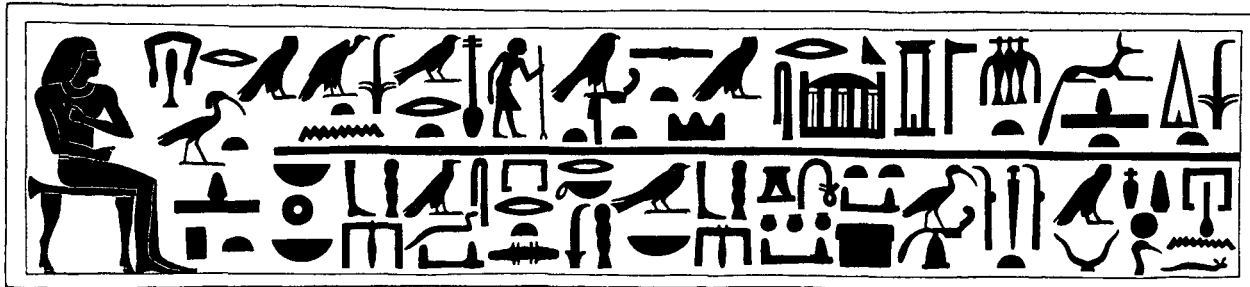

FIG. 132. Lintel of the Entrance.

Above the entrance, between the jambs, is a large drum bearing the inscription (fig. 135): 'He who is concerned with the King's Affairs, the Scribe of the Granary and the Treasury, Akhet-hetep'.

The Chapel is composed of two parts marked A and B on the plan (see fig. 130). A measures 3.13 ms. by 1.40 ms. and its roof consists of six slabs of white limestone whose breadth varies from 60 to 90 cms. These slabs are supported on the east by the outer wall of the mastabas and on the west by an architrave supported by a single column, square in section; both architrave and column are cut out of the native rock. In the eastern wall, high up, have been cut two small rectangular apertures which serve as windows. The architrave has incised upon it three long horizontal lines and four vertical columns of hieroglyphs, as well as a seated figure of Akhet-hetep (see fig. 136). When first discovered its inscriptions were covered with a thick coating of yellow mud.



FIG. 133.

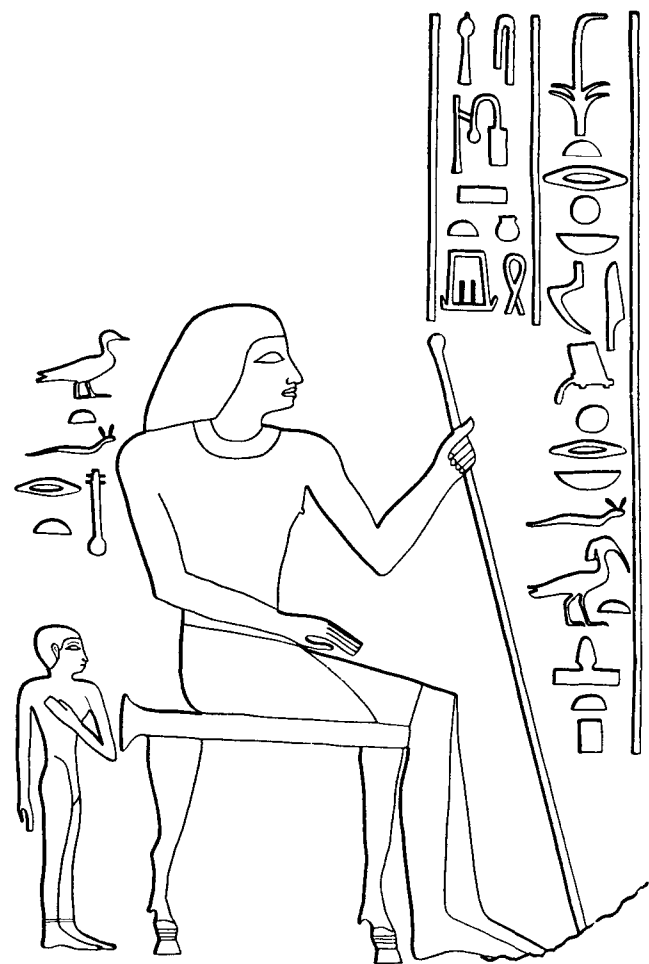

FIG. 134.

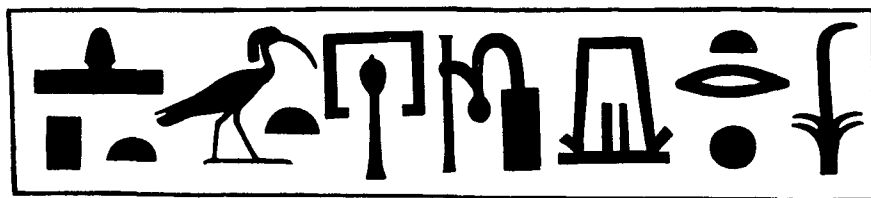

FIG. 135.

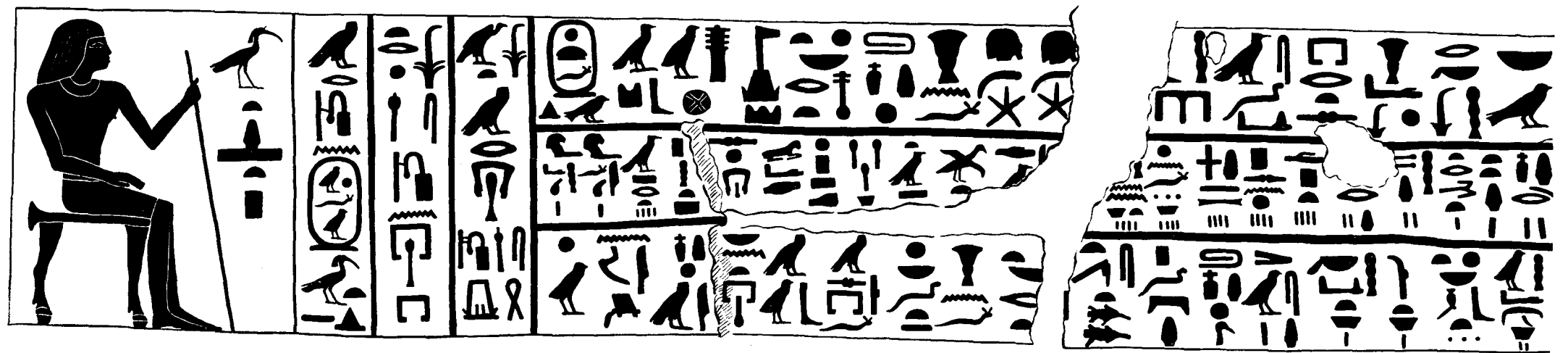
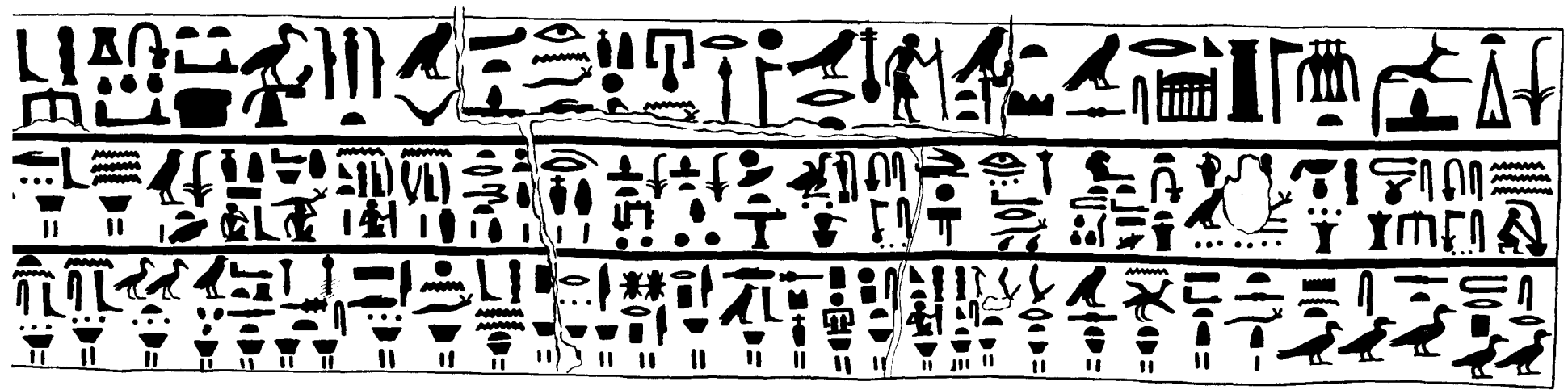

FIG. 136.

The inscription reads:

'A boon that the king gives, a boon of Anubis Presiding over the God's Dwelling; burial in the land of the west, he having reached a very good old age before the Great God, and that offerings come forth to him at the voice, that there be made for him an offering-table, at the Opening-day-of-the-Year Feast, the First of the Year Feast, the Feast of Thoth, the *W3g*-feast, the Great Feast, the Feast of Burning, the *w3h ch*-feast, the Feast of the Epiphany of Min, the Feast of *S3d*, at (every) feast of the Beginning of the Month, and of the Beginning of the Half-month, and that there may be offered to him every good thing of the Necropolis, of Dedu, of Abydos (and) of the Pyramid (named) Wer-Khafre.' Then follow, in lines 2 and 3, a long list of offerings 'that may be offered to him every day eternally in his tomb, (and) in any place where there is an offering for the honoured one' (continued in the vertical lines) 'the Overseer of the servants of the *ka* of the King's Mother, the Inspector of the Scribes of the Treasury, the Overseer of the Scribes of the Pyramid (called) Akhet-Khufu, Akhet-hetep.'

Northern face (Pl. XLVIII, 2 and fig. 137): Akhet-hetep is represented in a walking attitude facing ← with right leg forward. He wears a short wig, a short false beard, a necklace, and long loin-cloth projecting in front with fold at the side. The muscles of his fore-arms and legs are accentuated by broad chisel grooves. In his right hand he holds a long staff; his left arm hangs at his side with the hand closed. In front of him stands a nude male child whose right arm is bent round the lower end of Akhet-hetep's staff. Above Akhet-hetep are two horizontal lines of hieroglyphs giving his name and titles and above the child is an inscription reading 'His son', whose personal name is not given. Below is a herdsman leading a bull. *Western face* (Pl. XLIX, 2 and fig. 138): Akhet-hetep is represented in a walking attitude facing → with left leg forward. He wears a long wig, a necklace, and loin-cloth pointed in front. In his right hand he holds a handkerchief and in his left a long staff. In front of him stands a nude female child who holds in her left hand the lower end of Akhet-hetep's staff. Above Akhet-hetep are two horizontal lines of hieroglyphs giving his name and titles and above the child is an inscription reading 'His eldest daughter Nefret'. Below are three men clad in loin-cloths cutting up a trussed bull with knives. The pillar supporting the architrave is sculptured in sunk-relief with four scenes, one on each face. *Eastern face* (Pl. XLVIII, 1 and fig. 139): Akhet-hetep is represented in a walking attitude facing → with left leg forward. He wears a wig, necklace, kilt projecting in front, and a leopard skin suspended from his left shoulder; on his feet are sandals, in his right hand he holds a handkerchief, and in his left a long staff. Standing in front of him is a nude male child whose left arm is bent round the lower end of Akhet-hetep's staff. Above Akhet-hetep are two horizontal lines of hieroglyphs giving his name and titles and above the child is an inscription reading 'His son Rer-wer'. Below are three *ka*-servants clad in loin-cloths. The one on the right, named Herunefer faces ← and burns incense in a censer. The other two, named respectively Kay and . . . hernefert face → and are carrying toilet utensils; the first brings a box of unguents and a loin-cloth, the second brings the ewer and basin. *Southern face* (Pl. XLIX, 1 and fig. 140): Akhet-hetep is represented in a walking attitude facing → with left leg forwards. He wears a short wig, necklace, and loin-cloth crimped on one side. In his right hand he holds a handkerchief and in his left a long staff. Standing in front of him is a nude male child who holds the lower end of Akhet-hetep's staff in his left hand. Above Akhet-hetep are two horizontal lines of hieroglyphs giving his name and titles, and above the child is an inscription reading 'His eldest son Hamuka'. Below is a man driving

an oryx. Cut in the right wall is a doorway (see plan, fig. 130) giving access to the sarcophagus-chamber of Akhet-hetep's wife Nekauhathor; this chamber is without scenes or inscriptions

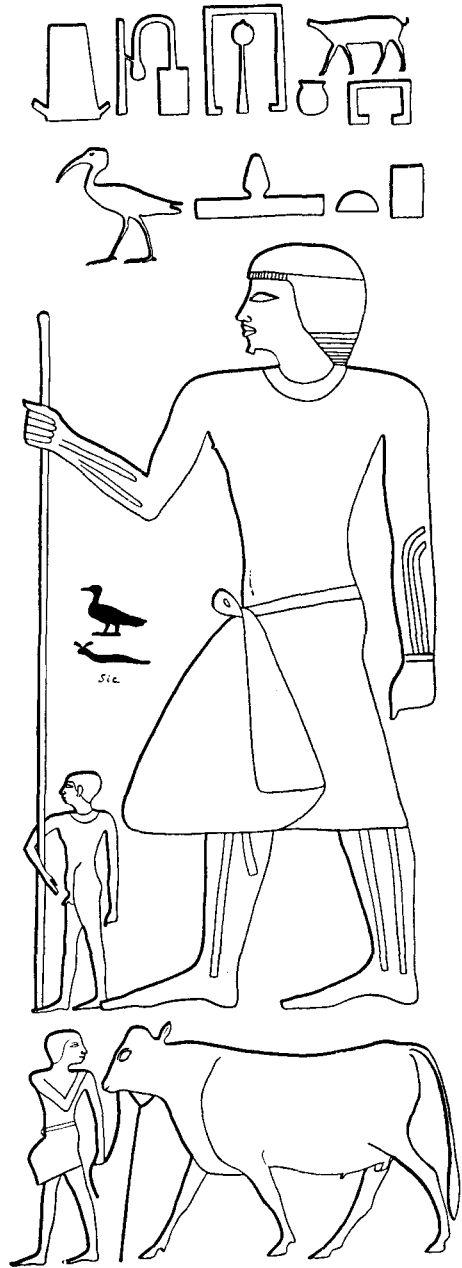

FIG. 137.

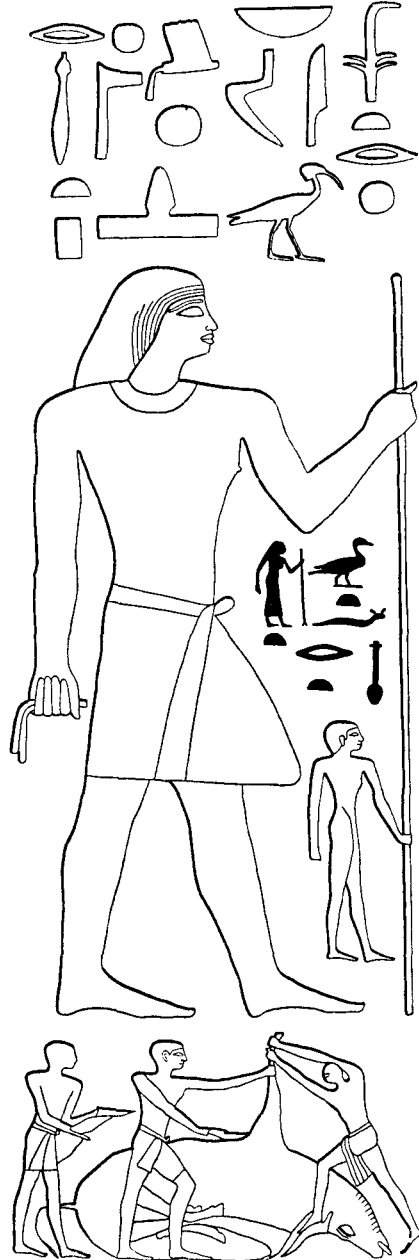

FIG. 138.

but it is situated immediately behind Nekauhathor's false-door which is built in the façade of the mastaba (see fig. 144).

B. This part of the chamber is entirely cut out of the native rock and measures 1·18 ms. to 2·20 ms. in depth, 7·13 ms. in width, and 2·15 ms. in height; its floor is on a slightly higher level than the floor of A. The outer, right- and left-hand walls are uninscribed, but on the inner wall (see fig. 141) are three false-doors and a palace-façade sculptured in relief.

FALSE-DOOR NO. I. Uninscribed.

FALSE-DOOR NO. 2. (see Pl. L and fig. 142) of Akhet-hetep. Built of five blocks of fine white Turah limestone. *Lintel*. Two horizontal lines of hieroglyphs reading ← : (1) 'A boon that



FIG. 139.

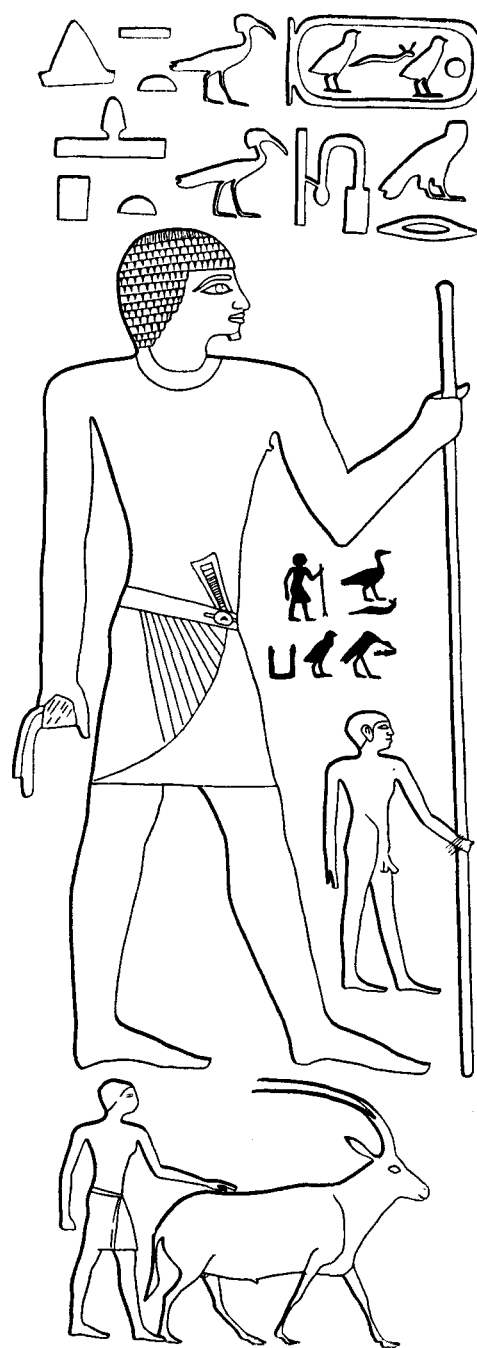

FIG. 140.

the king gives, a boon of Anubis Presiding over the God's Dwelling; a burial in the Land of the West, he having reached a very good old age before the Great God; that he pass over in peace the good roads over which the honoured ones pass' and that 'offerings come forth to him at the voice in every feast, every day eternally in any place where there is an offering for the Honoured One Akhet-hetep', (2) 'and that offerings come forth to him at the Opening-day-of-the-Year

Feast' (here follows a list of festivals), and that there be offered to him bread, beer, cakes, oxen, and all good things daily, the One who is concerned with the King's Affairs, the Honoured One before his Lord, the Overseer of the *Ka*-servants of the King's Mother, the Overseer of the Scribes of the pyramid named Akhet of Khufu, the Inspector of the Scribes of the Granary, the Inspector of the Scribes of the Treasury, Akhet-hetep'. At the end of these two lines of hieroglyphs is a seated figure of Akhet-hetep holding in his hand a long staff.

Left Jamb. Akhet-hetep is represented standing with left leg forwards facing →. He wears a long wig, a necklace, and a kilt pointed in front. His arms hang down at his sides with the hands open. Above him is his name with titles. Below is a male figure clad in a loin cloth and holding birds in his hands.

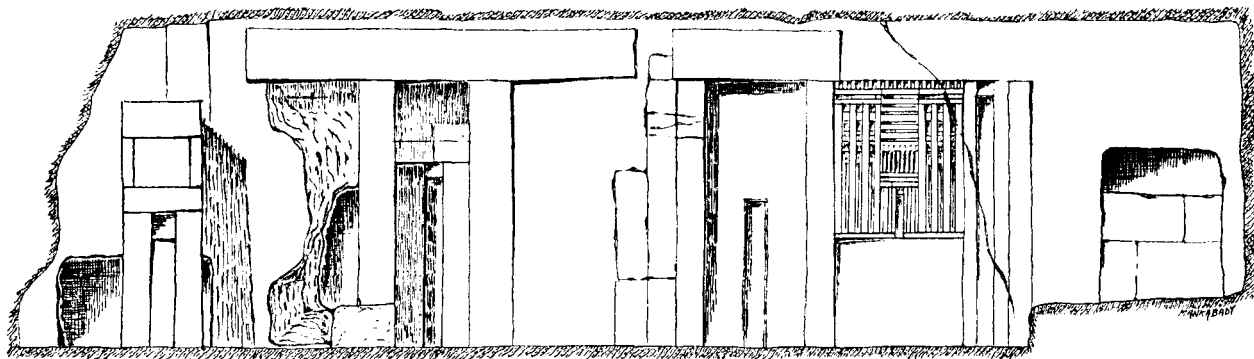

FIG. 141. Section: Mastaba of Akhet-hetep.

Right Jamb. Akhet-hetep is represented in the same attitude and wearing similar wig, necklace, and kilt as on the left jamb, but he faces ←. Above him is his name with titles. Below is a male figure clad in loin cloth, holding in his right hand a censer and in his left a piece of linen (? a loin cloth).

Panel between the upper part of the jambs. Here Akhet-hetep facing → is seated before a table of offerings. He wears a short wig and loin cloth; his left hand is raised to his breast, his right hand is extended forwards to the offering-table. Above the offering-table is Akhet-hetep's name with titles. Below the table is an inscription reading 'a thousand loaves, a thousand jars of beer, a thousand alabaster tables of offerings, a thousand garments'.

Inner Lintel. A horizontal line of hieroglyphs reading ← giving Akhet-hetep's name and titles.

Left Inner Jamb. Akhet-hetep facing → is clad in a short loin cloth. He wears a necklace but no wig, and his arms hang down at his sides. Above him is his name with titles.

Right Inner Jamb. Akhet-hetep facing ← is represented in a similar attitude and dress as on the opposite jamb. Above him is his name with titles.

Drum. The name 'Akhet-hetep' inscribed within a rectangle.

FALSE-DOOR NO. 3 (see Pl. LI, and fig. 143). Of Peseshet. Built of white limestone except its right-hand jamb which is cut in the native rock.

Lintel. Two horizontal lines of hieroglyphs reading ←. 'A boon that the King gives, a boon of Anubis Presiding over the God's Dwelling; burial in the Land of the West, she having reached a very good old age and possessing honour before the Great God; that offerings come forth to

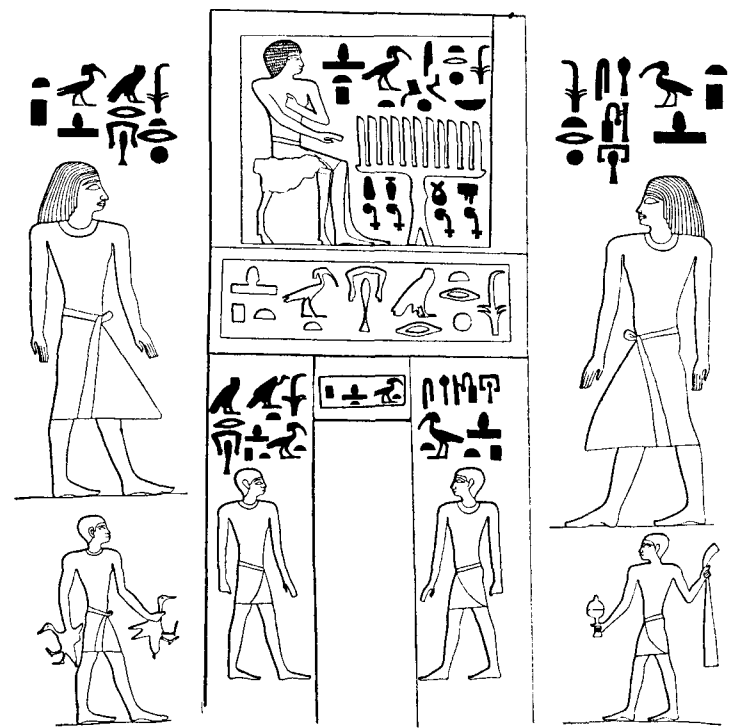
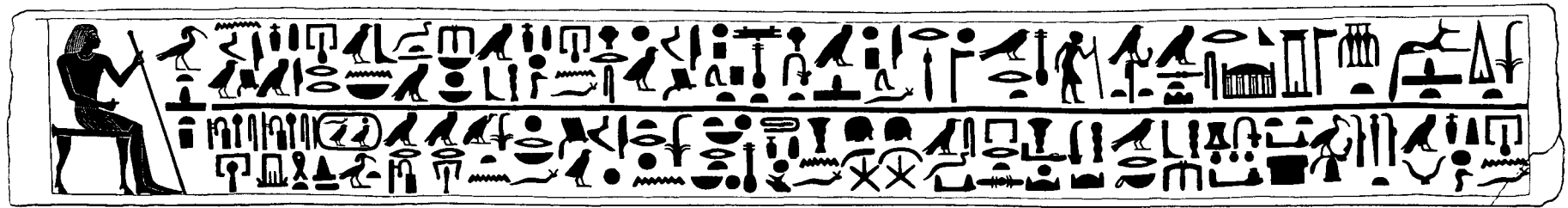

FIG. 142. Lintel and False-door of Akhet-hetep.

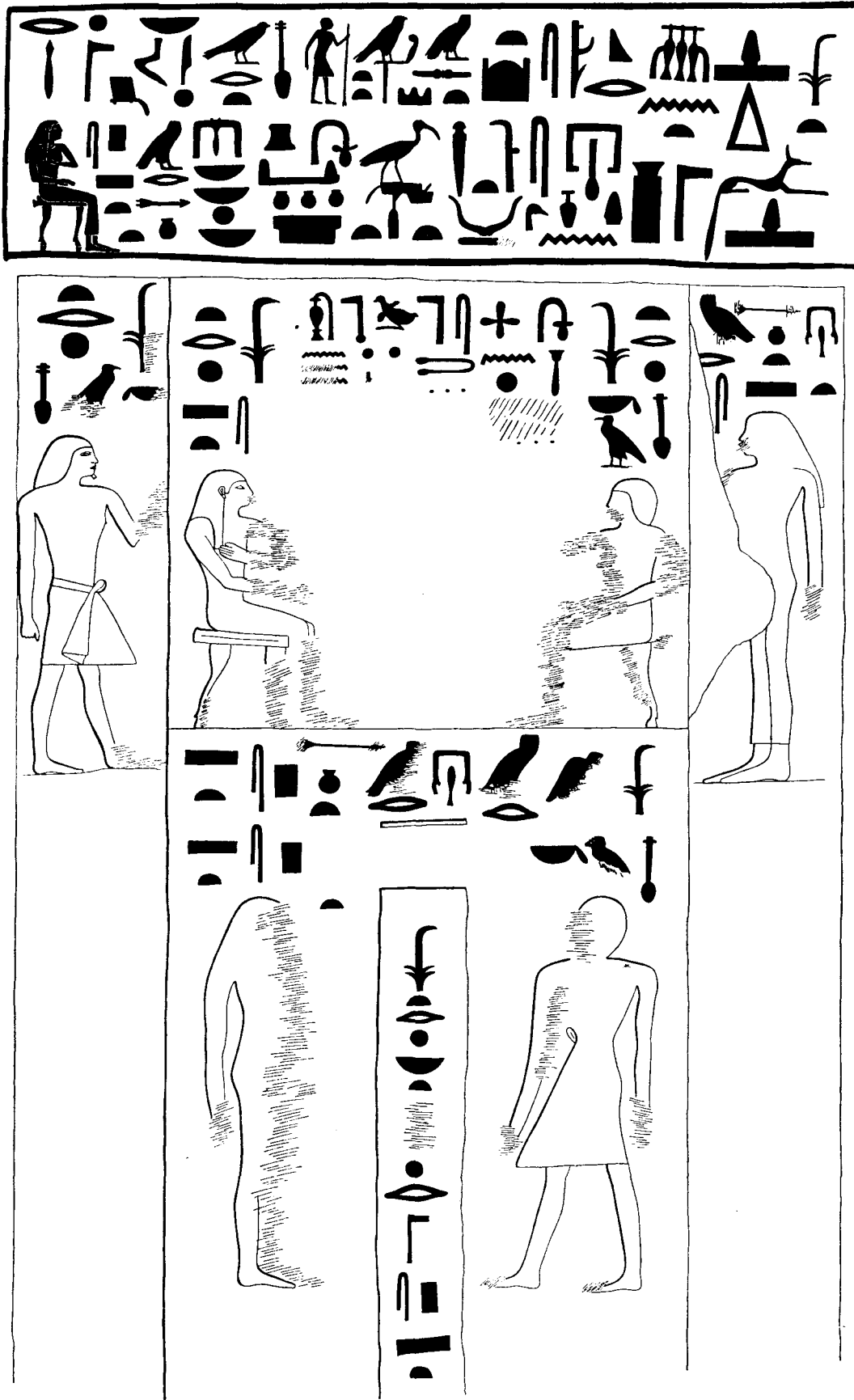

FIG. 143. False-door of Peseshet.

her at the voice in the Opening-day-of-the-Year Feast (here follows a short list of festivals); the Overseer of the Doctors Peseshet.'

Left Jamb. A male figure wearing a long wig and clad in a kilt pointed in front, stands with left leg forwards, facing →. His left arm is raised; his right arm hangs at his side. Above him is his name 'Kanefer', with title 'He who is concerned with the King's Affairs'.

Right Jamb. A female figure wearing a long wig and clad in a long close-fitting garment stands facing ←. Above her is her name '[Pe]seshet', with title 'Overseer of the Doctors and *Ka*-servants'.

Panel between the upper part of the jambs. The scene here, which is now partly destroyed, represented Peseshet facing → and Kanefer facing ←, seated on either side of a table of offerings. Above the two figures are their names and titles, and above the table of offerings (now destroyed) is an inscription reading 'purifying with water, natron, and incense; cloths and malachite' (for painting the eyelids).

Inner Lintel. A horizontal line of hieroglyphs reading—'The Overseer of the *Ka*-servants of the King's Mother, the Overseer of the Doctors, Peseshet'.

Left Inner Jamb. A figure of Peseshet standing; above her is her name.

Right Inner Jamb. A figure of Kanefer standing; above him is his name.

Doorway. A vertical column of hieroglyphs reading 'She who is concerned with the King's Affairs, possessing honour before the God, Peseshet'.

FALSE-DOOR OF NEKAUHATHOR (fig. 144).

This False-door is in the façade of the mastaba of Akhet-hetep some 2.65 ms. to the right of its entrance doorway. The lintel is of Turah limestone, the panel, inner lintel jambs and drum below are cut in the native rock.

Lintel. Two horizontal lines of hieroglyphs reading—(1) 'A boon that the King gives, a boon of Anubis, Lord of the Sacred Land; burial in the Land of the West for the Honoured One before the Great God, the One concerned with the King's Affairs, the *Ka*-servant of the King's Mother; (2) that offerings come forth to her at the voice in the Opening-of-the-Year Feast (here follows a list of festivals) for Nekauhathor'.

Panel. Nekauhathor is represented seated, facing →, before a table of offerings. She wears a long wig and is clad in a long close-fitting garment with straps over the shoulders. Her right hand rests on her right thigh; her left hand is extended to the table of offerings. Above is her name with titles. Below the offering-table is a similar inscription to that below the offering-table on the false-door of Akhet-hetep (p. 82).

Lower Lintel. A horizontal line of hieroglyphs reading—'The One concerned with the King's Affairs, possessing honour before the Great God, Nekauhathor'.

Drum. The name Nekauhathor without titles.

Jambs. Uninscribed.

BURIAL CHAMBERS in the mortuary chapel of Akhet-hetep.

1. That of Akhet-hetep himself is cut in the native rock in the western wall behind his False-door. It measures 1.68 ms. by 1.63 ms. Instead of making a separate sarcophagus, a rectangular depression was cut in the floor for the reception of the body. After burial the False-door was

built over the entrance to the chamber and the stone slabs used for this purpose were bound by mortar. Contents: A body much decomposed and covered with clean sand. At the head were pieces of charcoal and between the legs a bowl of polished red pottery (Pl. LXXX, B. first bowl on left side of bottom row).

2. That of Nekauhathor is situated behind her False-door (see plan, fig. 130). It is cut in the

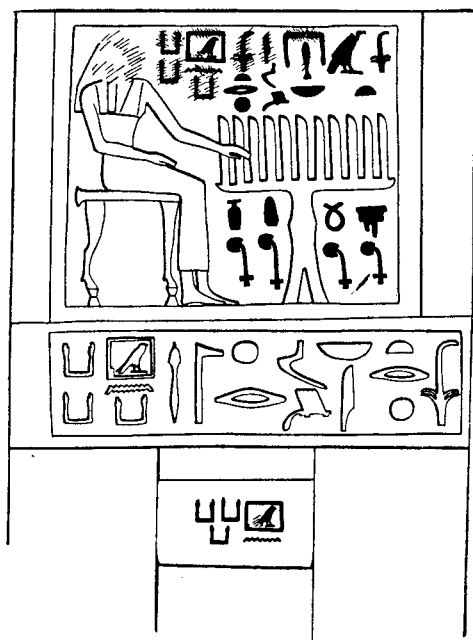

FIG. 144.

native rock and has a similar depression in the floor to that of Akhet-hetep. Contents: A decomposed human body much broken by the falling in of one of the covering-stones that formed the lid of the depression. No objects were discovered with this body.

3. On the right of the False-door of Akhet-hetep is a large slab of local limestone carved in the shape of a rough false-door. Behind it is a burial chamber measuring 1.70 m. by 1.00 m. by 0.80 m. Contents: The body of a male laying with head to the north and facing east. No objects were discovered with this body.

4. In the middle of the southern wall of the 'B' division of the Mortuary chapel is another small burial chamber measuring 1.03 by 0.75 m. Its entrance was open when the mastaba was discovered. Contents: A few broken decomposed human bones.

5. At the northern side of 'B' is a raised platform cut in the rock, and on its western side is an opening that leads to a small irregularly cut burial chamber measuring 0.75 m. by 1.05 m. by 0.90 m. It contained no objects.

SHAFTS.

1. In front of the door of the burial chamber of Nekauhathor is a shallow shaft (fig. 145) measuring 1·10 ms. by 1·10 ms. with sarcophagus recess below. Contents: No traces of human bones, but in the debris which filled the shaft was a large ring-stand of red pottery nearly complete (Pl. LXXX, B. top row second from left).

2. In the floor of the Mortuary chapel near the first and second False-doors is a shaft measuring 1·25 ms. by 1·25 ms. and 5·60 ms. deep (fig. 146). Contents: The sarcophagus recess at the bottom was filled with water, on the surface of which were some floating human bones.

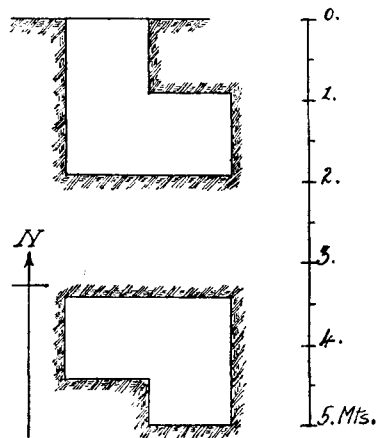

FIG. 145.

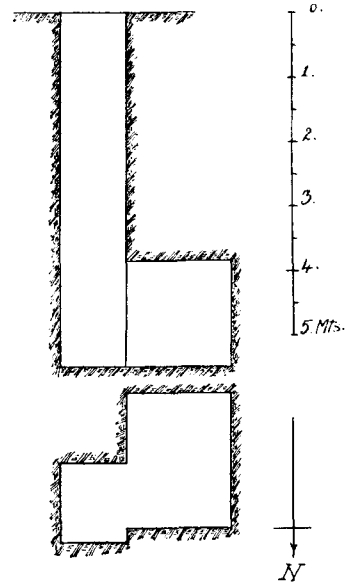



FIG. 146.

THE MASTABA OF THE  OVERSEER OF THE KA-SERVANTS,
 DEDA.

THE Rock-cut Mastaba of Deda is situated to the north-east of the Mastaba of Akhet-hetep, near the south-eastern corner of the Tomb of Re-wer. It is rectangular in plan (fig. 147), measuring 4·20 ms. by 2·00 ms., and is below the level of the neighbouring Mastabas. It is approached from the south by means of descending steps cut in the rock which lead to a small court 2·75 ms. by 1·65 ms., in the western side of which is the entrance to the Mortuary Chamber of the Mastaba. Above the lintel of the doorway there are two courses of local limestone blocks; the lintel itself and the drum below it is cut out of the native rock (Pl. LII). The Mortuary Chamber measures 4·30 ms. by 1·95 ms. and is 2·05 ms. high.

Outer wall: On the right-hand side of the entrance is a Niche with standing figure of a man cut in the rock (Pl. LIII, 1); the head and torso are well sculptured but the lower part of the figure is unfinished. *Right-hand wall:* A large Niche with three male figures, standing (Pl. LIV, 1), cut in the rock; these are all unfinished and there still remain the sculptor's 'guiding lines' in red paint outlining the figures. *Left-hand wall:* A large Niche with three male figures, standing (Pl. LIV, 2), all much weathered and apparently all unfinished. *Inner wall:* A large Niche with four male figures, standing (Pl. LIII, 2), cut in the rock. On either side of this Niche there is

a False-door, the one on the northern side is uninscribed, but that on the southern side preserves the name and title of the owner of the Mastaba.

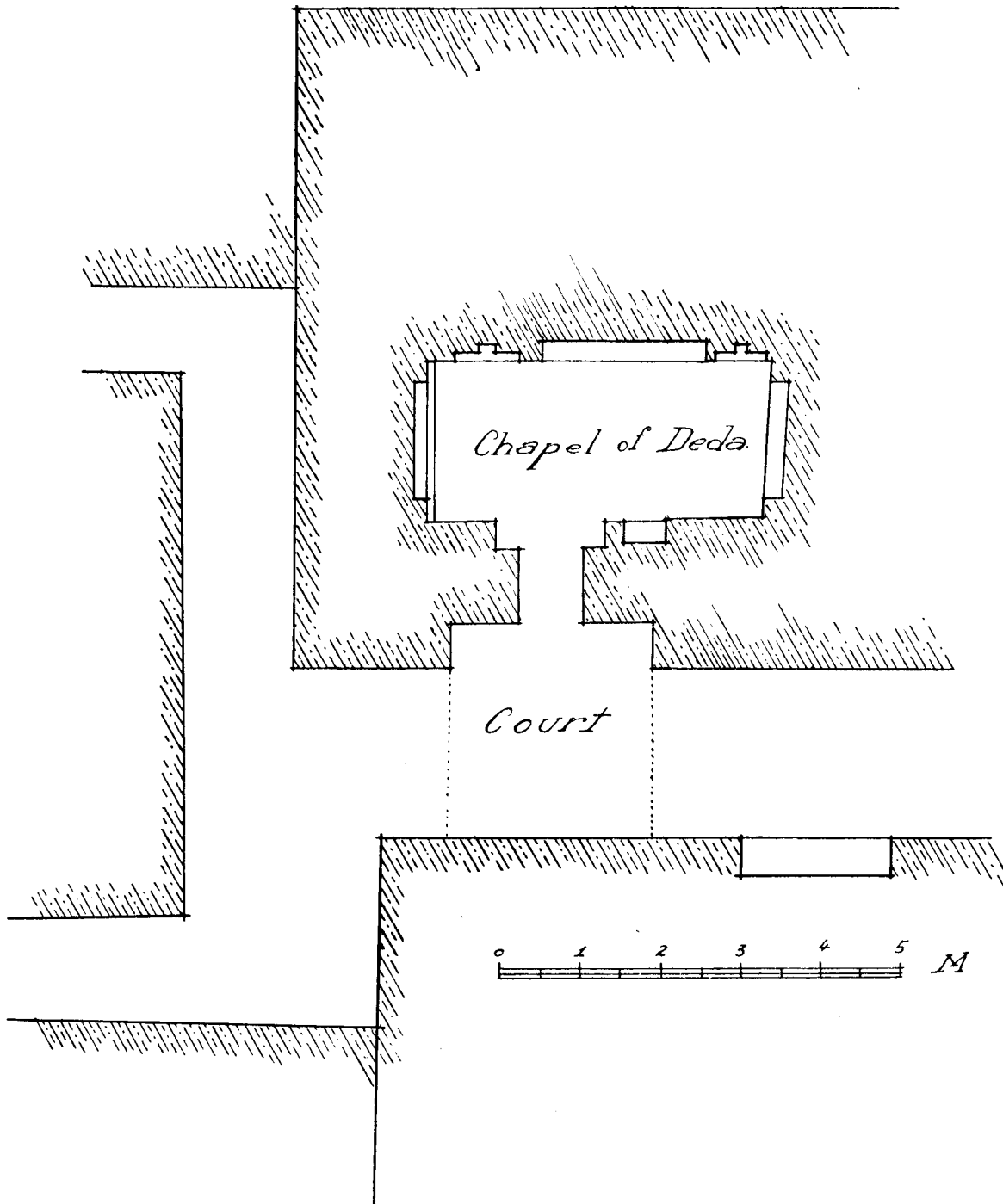

FIG. 147. Plan of the Mastaba of Deda.

The Inscribed False-door (fig. 148). Only the upper part of this is preserved and even this is much weathered. On the panel above the lintel was a scene of the owner of the Mastaba and his wife (?) seated before a table with offerings. On the lintel below was a prayer for 'a good burial in the necropolis for the honoured one before the Great God, the Overseer of the *Ka*-servants, Deda'.

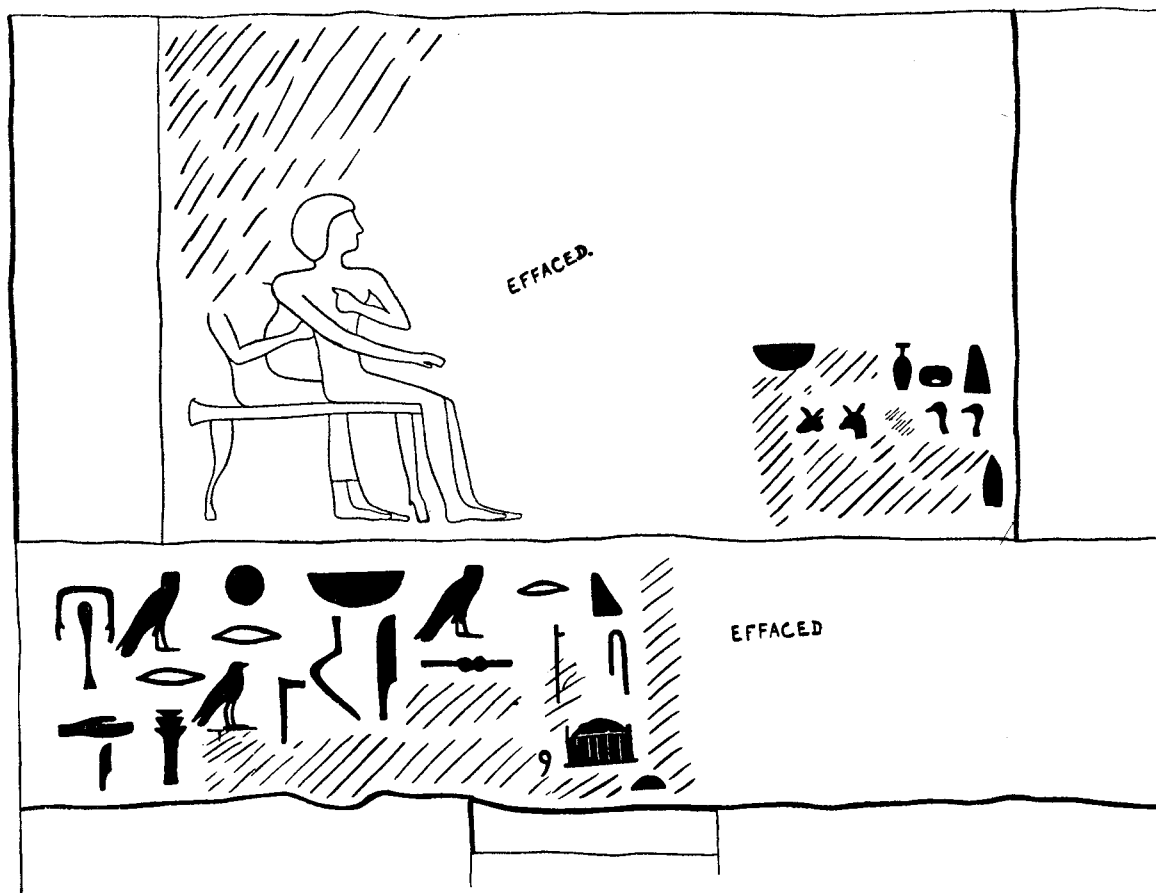

FIG. 148. Upper part of False-door of Deva.

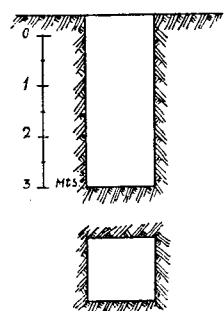

FIG. 149.

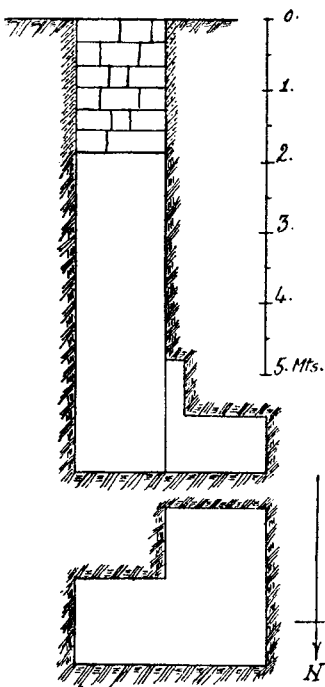

FIG. 150.

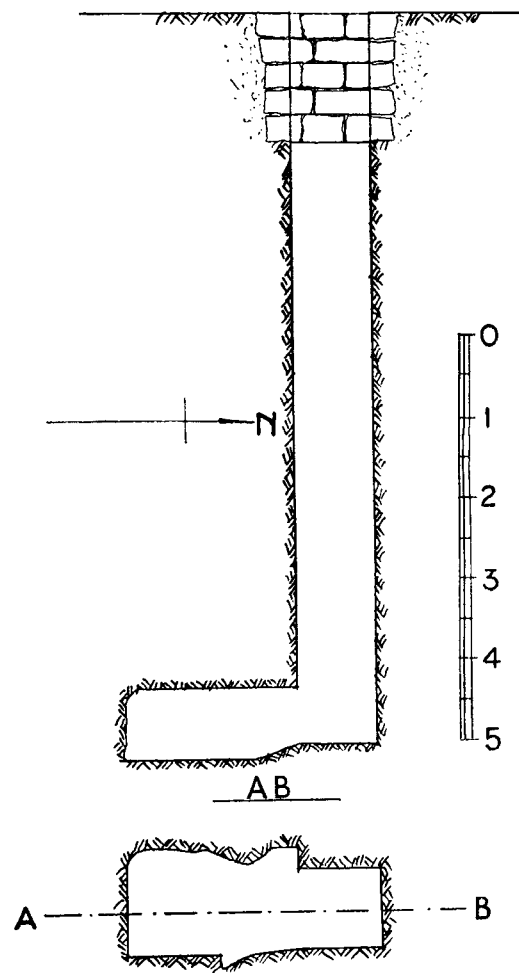

FIG. 151.

SHAFTS. *Shaft No. 117* (fig. 149), 3.45 ms. deep, unfinished. Contents, nil.

Shaft No. 60 (fig. 150), 6 ms. deep, with Sarcophagus Chamber at bottom on west side. Contents, nil.

Shaft No. 80 (fig. 151), 9 ms. deep, with Sarcophagus Chamber at bottom on south side. Contents, some fragments of human bones.

THE UNINSCRIBED ROCK-CUT MASTABA

THIS Mastaba is situated to the south of the Tomb of *Rer-wer*, and west of the Mastabas of *Akhet-hetep* and *Imby* (see General Plan); it is probably older than the Tomb of *Rer-wer*, for there is a window to his *Serdab No. 23* opening on to its Forecourt. In front of the façade (Pl. LV) is a spacious rectangular Courtyard measuring 40 ms. by 5.60 ms., which occupies the whole length of the Mastaba; the eastern and southern walls are built of crude brick, the lower courses of which alone remain; the northern wall is the southern wall of *Rer-wer's Serdab No. 23*; the western wall is the rock-cut façade of the Mastaba. The eastern and southern walls are of recessed brick-work; between every three 'single' recesses or niches is a 'double' recess or niche; altogether there are 43 single and 13 double niches. In the eastern wall, near its centre, is an opening or doorway leading to the Street of the Priests (see General Plan), and at the southern end of the same wall is a doorway giving access to a short passage which opens on to a small brick chamber that is marked 'Store' on the Plan. Near the front of the entrance to the Mastaba two ivory castanets (Pl. XLV, 2) were found in the sand.

The outer face of the rock in which the Mastaba is cut was cased with large slabs of Turah limestone. The thickness of this casing at the floor level is about 1.80 ms., but the thickness gradually decreases in the upper courses; the lowest course of casing slabs is fitted into a space, 25 cms. deep, sunk in the floor of the Courtyard. A few slabs of this casing still remain *in situ*. In front of the entrance to the Mortuary Chapel, at a distance of about 2.47 ms. from its façade wall, is a 'curtain wall', partly cut in the rock and partly built of brick, 85 cms. high by 2.30 ms. long.

The Mortuary Chapel. The doorway giving access to the Mortuary Chapel is 3.60 ms. in height by 90 cms. wide; the outer jambs and passage-way were cased with Turah limestone. The Chapel, entirely cut in the native rock, measures 8.38 ms. by 3.45 ms. On the eastern wall, on both sides of the entrance, are built screen walls of limestone blocks (see Plan, fig. 152). The floor of the centre part of the Chapel is paved with large slabs of limestone, each slab being about 20 cms. thick. On the left side of the entrance a rectangular basin of fine Turah limestone, 54 cms. by 32 cms. by 33 cms., has been let into a hole sunk in the floor. To the west of this basin are two circular depressions, each 60 cms. in diameter, sunk in the floor. Fragments of alabaster were found in them and they were probably used for libation tables. In the northern wall of the Chapel is cut a descending passage, measuring 1.20 ms. by 1.35 ms., by 5 ms. deep; the end of this passage has been left rough. In the western wall, at about 1/m. from the floor level, a False-door (80 cms. by 25 cms.) has been cut in the rock. On the right-hand side of the western wall is a rectangular opening (height 1.25 ms., width 1.15 ms.) giving access to a descending passage leading to the Sarcophagus Chamber. In this passage was a large block of compact limestone that had been used to close the Sarcophagus Chamber. The Chamber itself is rectangular, and measures 5.25 ms. by 2.75 ms. By the western wall is a sarcophagus of red granite, without inscriptions. Its exterior measurements are 2.21 ms. by 1.01 ms.

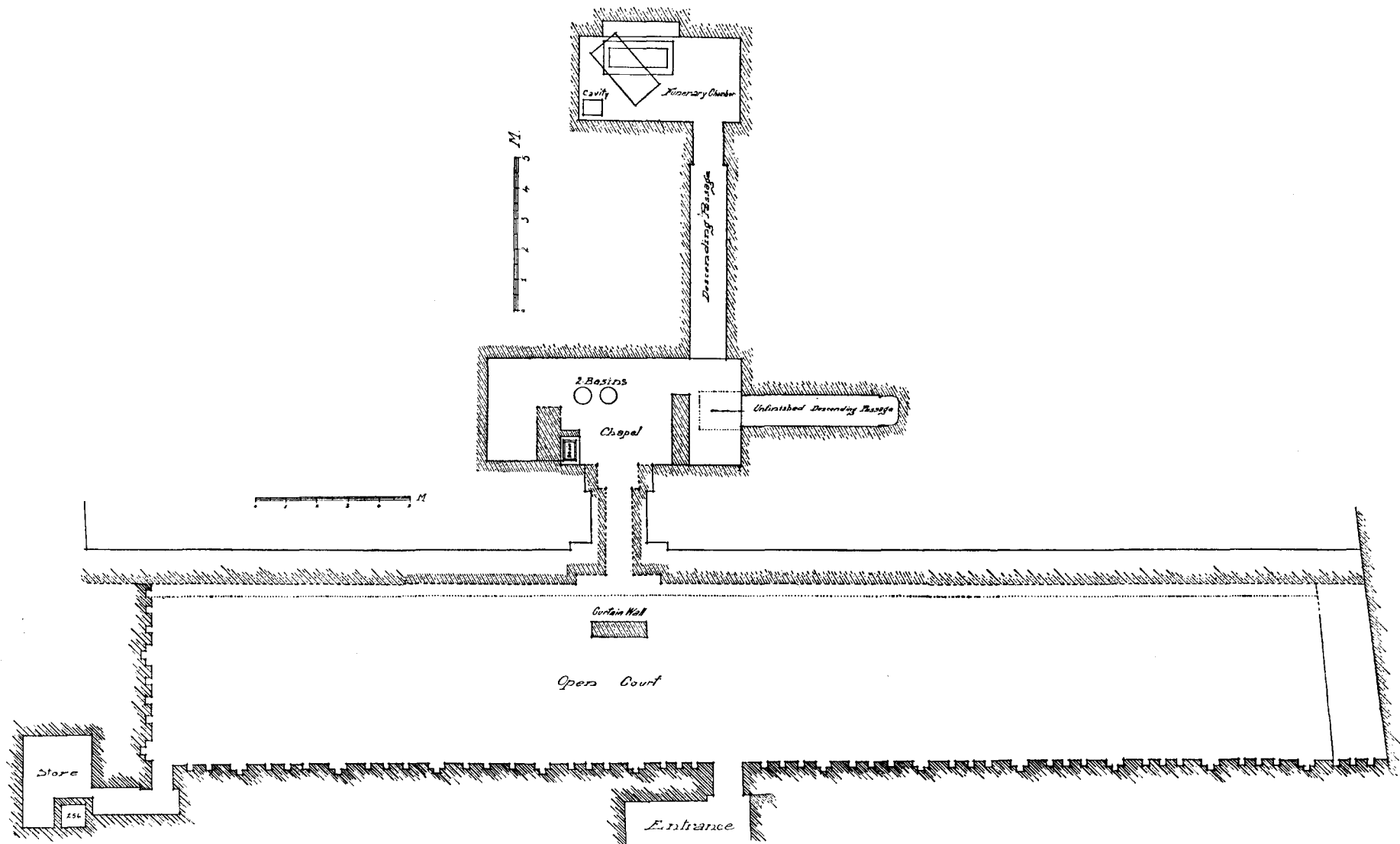

FIG. 152. Plan of the Uninscribed Rock-cut Mastaba.

by 78 cms.; its interior measurements, 1·85 ms. by 58 cms. by 61 cms. The outer surface is finely polished. The lid, of one piece of granite, was found resting on the sarcophagus which had been pilfered in ancient times and was empty. In the western wall of the Chamber there is cut a cavity 2·50 ms. by 50 cms. and in the floor at its south-east corner is a square hole 55 cms. by 55 cms. by 50 cms. deep; this was probably for the canopic jars. An alabaster saucer and a fragment of a second one, as well as two alabaster cups, were found in the debris of this chamber (fig. 153).



FIG. 153. Alabaster Cups and Saucers.

THE MASTABA OF  IMBY

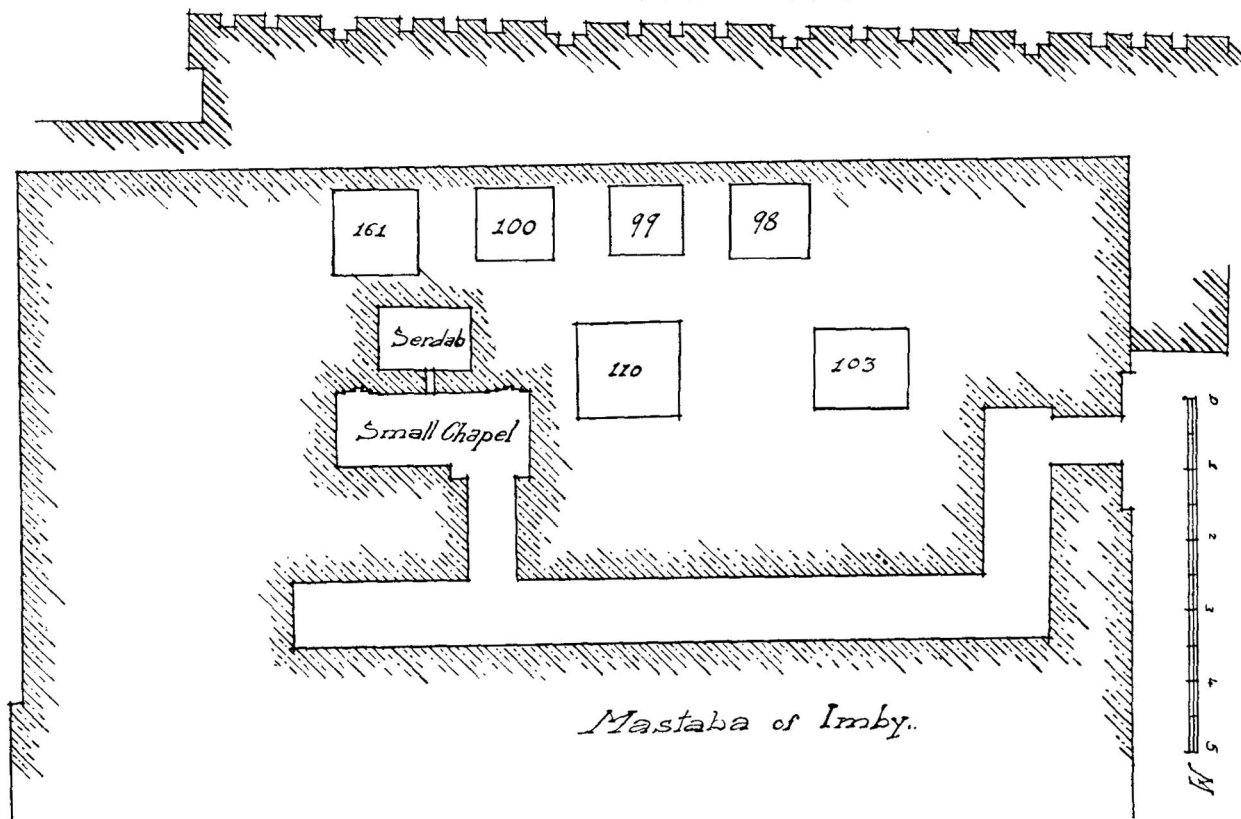

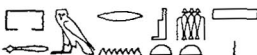

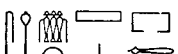

FIG. 154. Plan of the Mastaba of Imby.

TITLES OF IMBY

1.  Overseer of the *Ka*-servants.
2.  Overseer of the *Ka*-servants of the King's Mother.
3.  Director of the of the Great House.

4.  He who is concerned with the King's Affairs.
5.  Inspector of the Great House(?)
6.  Inspector of the Tenants(?) of the Great House.

FAMILY OF IMBY

Wife:  Nefert.

THIS Mastaba is situated at the south-western end of the street running east from the Courtyard of the Uninscribed Rock-cut Tomb (see General Plan). It is partly cut in the native rock and partly built of local stone. Its entrance faces north; the lintel, of white limestone (Pl. LVI, 2, and fig. 155), had fallen and was found lying in the debris in front of the Mastaba. It is inscribed with two lines of hieroglyphs, incised and coloured blue, reading ←.

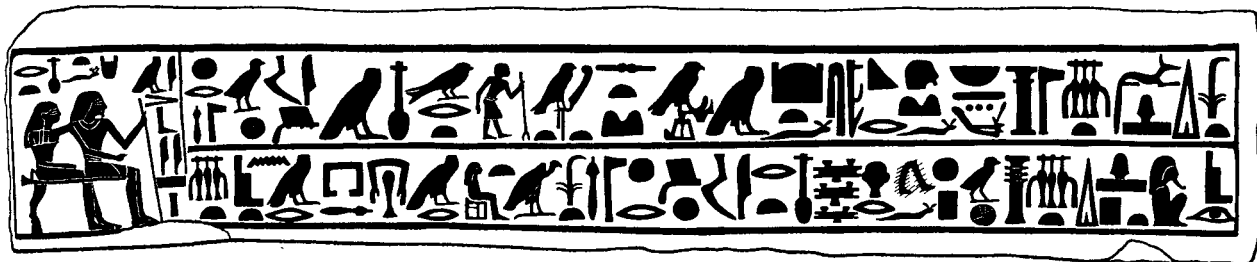



FIG. 155. Lintel of the Mastaba of Imby.

(1) 'A boon which the King gives, a boon which Anubus Presiding over the God's dwelling, Lord of the Sacred Land, He who presides over his Hill, (gives), that he (Imby) may be buried in the necropolis of the western desert, at a very good old age, as one who is honoured in the presence of the Great God'. (2) 'A boon which Osiris, who presides in Dadu (Busiris), gives, that he may walk on the goodly ways, as one who is honoured before the Great God, the Overseer of the *Ka*-servants of the King's Mother, the Director of the Royal Palace and of the landholders, Imby (and) his wife, Nefert'. Note that the group  at the end of line 2 serves also to determine the personal name Imby as well as .

A drum of white limestone, much weathered but still *in situ* over the entrance (Pl. LVI, 1), has incised on it a horizontal line of hieroglyphs reading ←.

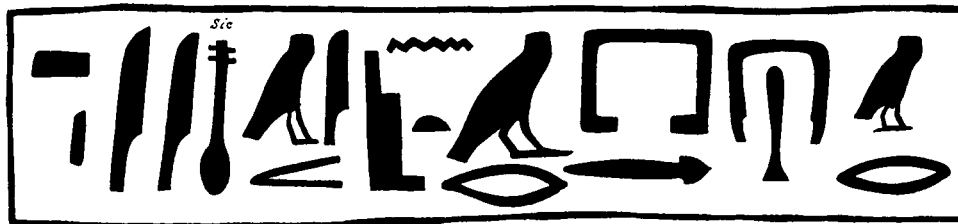



FIG. 156. Drum of Entrance Doorway to the Mastaba of Imby.

'The Overseer of the *Ka*-servants, the Director of the Royal Palace, Imby'. Note here that there is a scribal error  for  in the personal name.

The jambs of the doorway are uninscribed; the door was of one leaf. Immediately before the entrance there was found lying on the ground a large slab of local stone (Pl. LVI, 1) beneath which was the skeleton of a man. The doorway gives access to a short passage running from west to east, which leads to another passage at right angles to the first one; this second passage measures 10 ms. by 1.05 ms. Both passages are partly cut in the rock and partly built of local stone. The long passage was roofed with large slabs of limestone, each measuring about 1.25 ms. by 60 cms. by 20 cms.; nine of these roofing-slabs are still in place. Several skeletons were discovered in the passage which had evidently been used as a place of burial in late times. At a distance of 1.35 ms. from the northern end of the passage is a roughly carved False-door (1 m. by 40 cms.), without any inscriptions. At a distance of 6.90 ms. from the northern end is a doorway, also uninscribed, which gives access to the Mortuary Chapel. In the western wall of this Chapel there are two False-doors. The first is immediately opposite the entrance and is composed of two slabs of local limestone. On its lintel is incised a figure of Imby's wife facing ← and seated on a chair (fig. 157). Before her is a horizontal line of hieroglyphs reading → 'The One concerned with the King's Affairs, his wife, Nefert'.

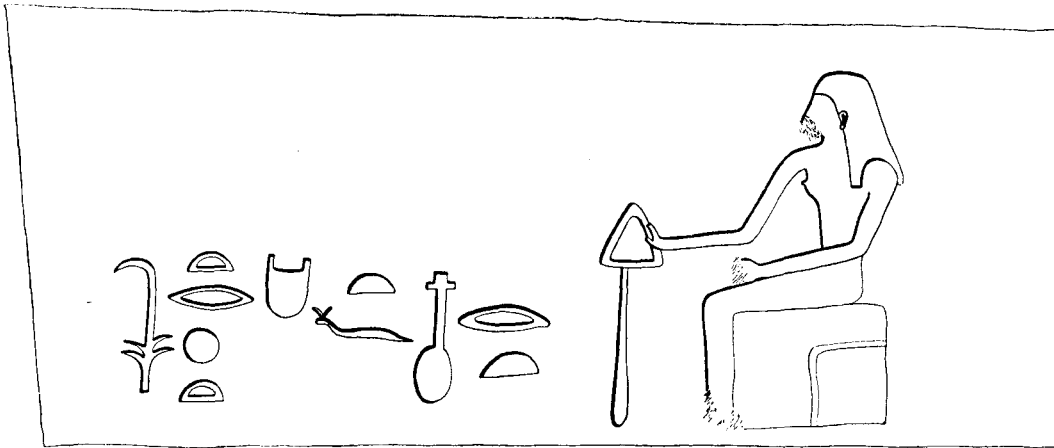

FIG. 157. Lintel of False-door No. 1, in the Mortuary Chapel of Imby.

On the left-hand side of the western wall is a second False-door (Pl. LVI, 3, and fig. 158); this measures 2 ms. in height and 73 cms. in width. The outer lintel and jambs, as well as the drum and inner jambs, are uninscribed. On the panel above the inner lintel is incised a seated figure of Imby holding in his right hand a long staff. Before him was his name, but of this only the two last hieroglyphs remain. On the inner lintel is a horizontal line of hieroglyphs reading ←: 'The Overseer of the *Ka*-servants of the King's Mother, Imby'.

Between these two False-doors, at a height of 1.25 ms. from the floor, is the square aperture (7 cms. by 7 cms.) to the Serdab of Imby; this Serdab measures 1.25 ms. in length, by 0.95 m. wide, by 1.30 ms. high. In it was found a Statuette of Imby (Pl. LVII). This is of limestone, painted, and measures 68 cms. in height, while the breadth across the shoulders is 26 cms. Imby is represented seated upon a stool; he wears a short black wig, a broad necklace, and a loin-cloth. His skin is coloured red; the eyebrows and eyelashes are black and his moustache is represented by a thin black line. The left fore-arm rests upon his left thigh with the hand open, palm downwards. The right fore-arm rests on his right thigh with the hand closed. The legs and feet



FIG. 158. Panel and Inner Lintel of the False-door of Imby.

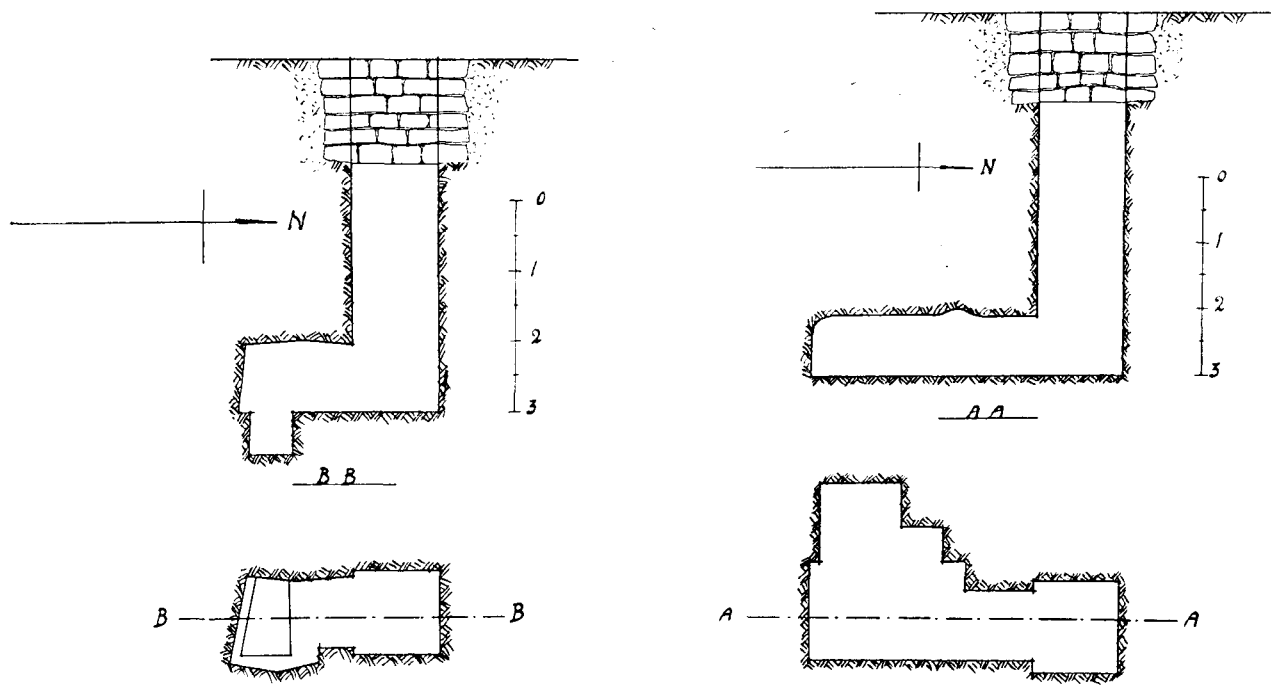



FIG. 159.

FIG. 160.

are slightly separated from one another. On the front of the stool on either side of Imby's legs are incised his name and titles, reading:—

Right side: 

Left side: 

The stool and pedestal were painted black but only slight traces of the paint remain.

SHAFTS. *Shaft No. 109* (fig. 159), 5 ms. deep, with Sarcophagus Chamber at bottom on south side. There is a rectangular cutting in the floor of the chamber for the reception of the dead body.

Shaft No. 110 (fig. 160), 5.40 ms. deep, with Sarcophagus Chamber at bottom on south side. In this chamber were found two skeletons lying on the floor on their left sides with heads north.

THE MASTABA OF WESER

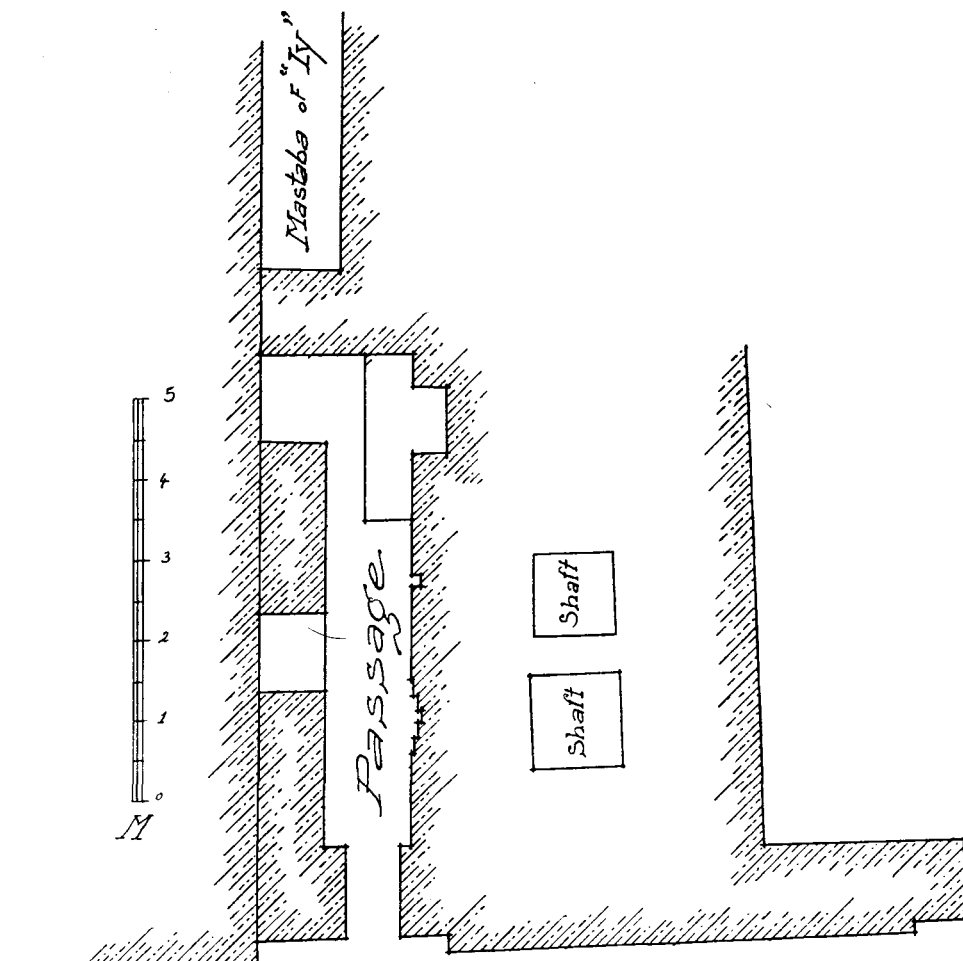

Mastaba of Weser.

FIG. 161. Plan of the Mastaba of Weser.

THIS Mastaba is situated to the east of that of Imby and west of that of Fifi (see General Plan). Its façade faces north, is built of large blocks of local limestone, and is plain (Pl. LVIII), except

for its lintel which is inscribed. The entrance doorway is not symmetrically placed in the centre of the façade but is nearer to the western side than to the eastern. The lintel is composed of two large blocks of limestone, measuring respectively 1.77 ms. by 42 cms. and 65 cms. by 40 cms., and is badly weathered. The inscription upon it is incised and originally consisted of two horizontal lines of hieroglyphs, but only the first signs of the first line are preserved (fig. 162). It reads ← and gave (1) the $\downarrow \triangle \text{---}$ formula to (?); (2) for 'pr-hrw-offerings at the feasts of the



FIG. 162. Lintel of the Entrance to the Mastaba of Weser.

Opening of the Year, at the New Year, at the feast of Thoth, at the *W3g*-feast, at every feast of every day, of the first of the month and at the first of the half-month, (for) the Overseer of the *Ka*-servants, Weser'. At the end of the inscription there is a figure of Weser seated on a chair and behind him is a woman, probably his wife, seated upon the ground; her left hand is raised to her breast and her right hand is open and rests upon her thigh. Below the lintel is a large drum cut in Turah limestone (fig. 163). It is inscribed with two horizontal lines of hieroglyphs reading ←: (1) 'The One concerned with the King's Affairs, the Steward, the Overseer of the *Ka*-servants, (2) the Honoured One in the presence of the Great God, the Lord of Burial, Weser'.

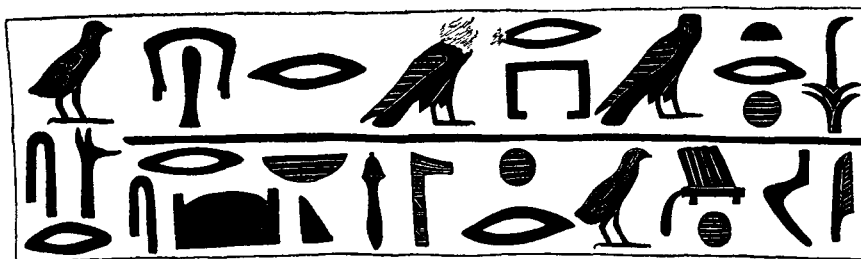

FIG. 163.

Beyond the doorway is a narrow chamber, 6.15 ms. long by 90 cms. broad. On its western wall, at a distance of 97 cms. from the entrance, is an uninscribed False-door of a single slab of Turah limestone. Further on, at a distance of 1.20 ms. is another False-door carved in the wall; its upper part has been broken off and is missing. Beyond this again, at a distance of 1.50 ms. is a niche, 84 cms. by 46 cms. by 1.90 ms., cut in the rock. In front of this niche is a rectangular platform also cut in the native rock (2 ms. by 60 cms. by 45 cms.), extending to the southern wall of the chamber. In the eastern wall there are two niches; a shaft is cut in the floor of the first; the second is opposite the niche in the western wall.

SHAFTS. There are two Shafts in the Mastaba. The first (fig. 164), behind the first False-door, is 2.20 ms. deep with an unfinished chamber at the bottom on the west side. It contained only

a few human bones. The second Shaft (fig. 165), behind the second False-door, is 5.20 ms. deep, with a Sarcophagus Chamber below on the west side. This chamber is roughly cut and unfinished.

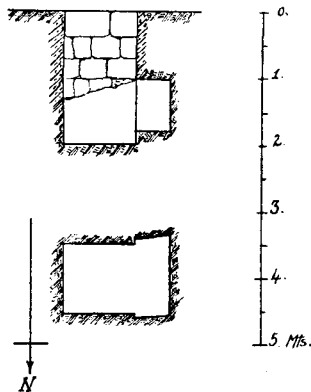

FIG. 164.

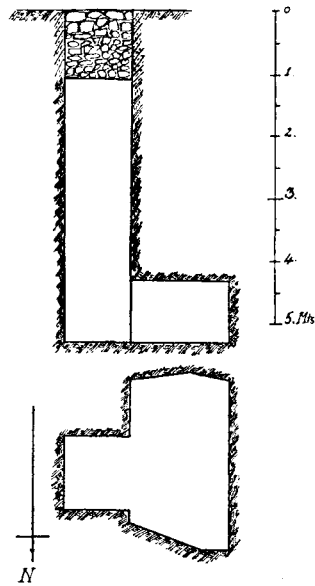





FIG. 165.

MASTABA OF  FEFI, called  PTAHSEZEFA

TITLES OF FEFI

1.  'He who is concerned with the King's Affairs'.
2.  'Overseer of the *Ka*-servants'.

FAMILY OF FEFI

Wife:  Hetepheres with the title  'She who is concerned with the King's Affairs'.

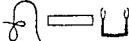
Son:  Weshka.

Daughter:  Neferkaues.

THIS Mastaba is situated to the left of that of Weser and in the same street. The area to the east of it has not yet been cleared; therefore the street, which runs eastwards from the court of the large Rock-cut Mastaba (p. 89), at present stops here.

The Mastaba measures 11.80 ms. by 8.30 ms. It is partly cut in the native rock and partly built of slabs of local limestone. The entrance is to the north and the façade is bounded by projections on both sides of the jambs (Pl. LIX). The lintel is broken away but seventeen fragments of it were found lying on the ground by the doorway (see fig. 167).

The drum above the doorway remains *in situ*; it is of Turah limestone and bears an inscription in relief (see fig. 168) reading 'He who is concerned with the King's Affairs, the Overseer of the

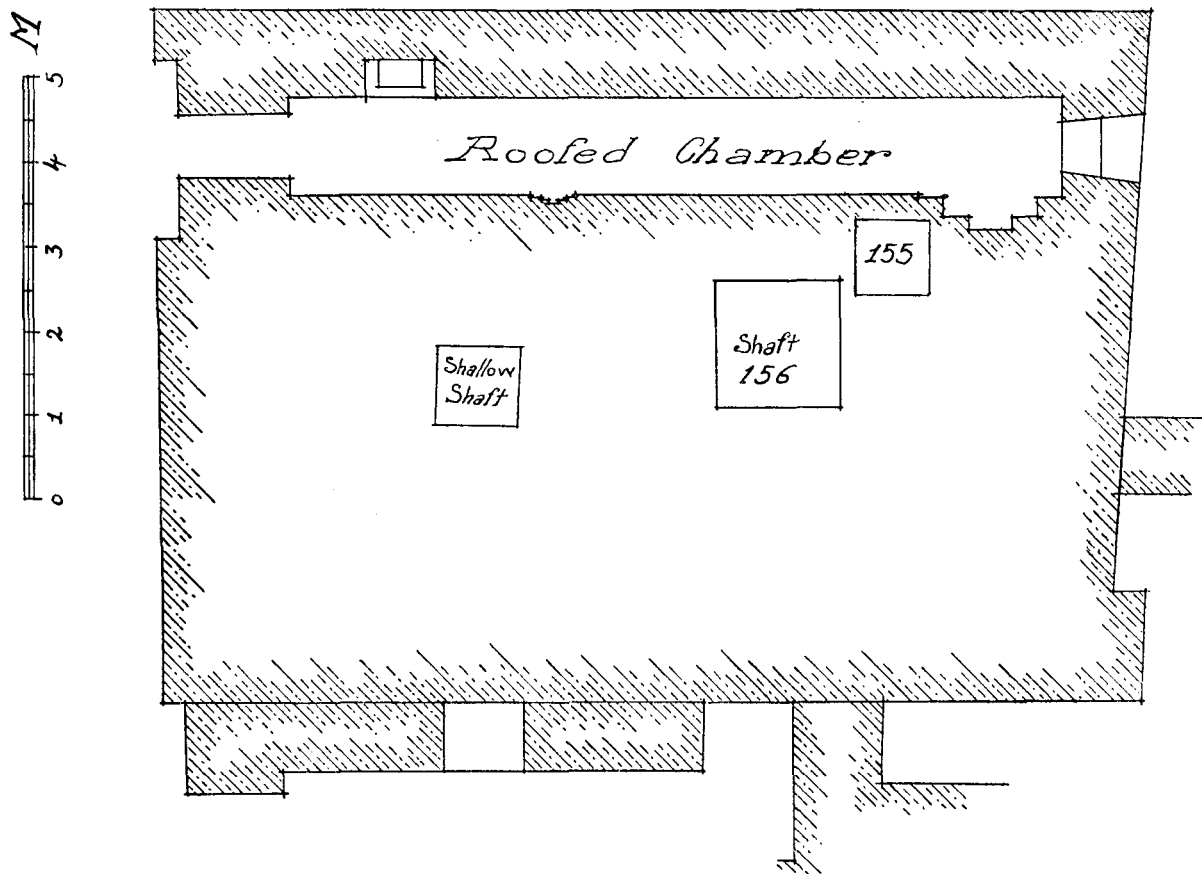

FIG. 166. Plan of Mastaba of Fefi.

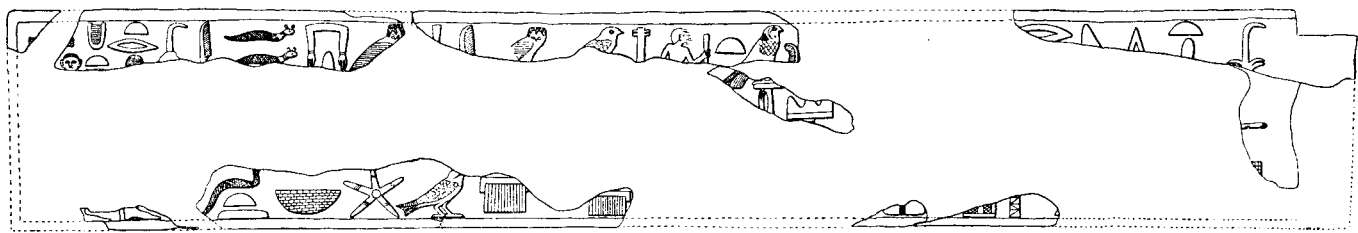

FIG. 167. Fragments of the Lintel.

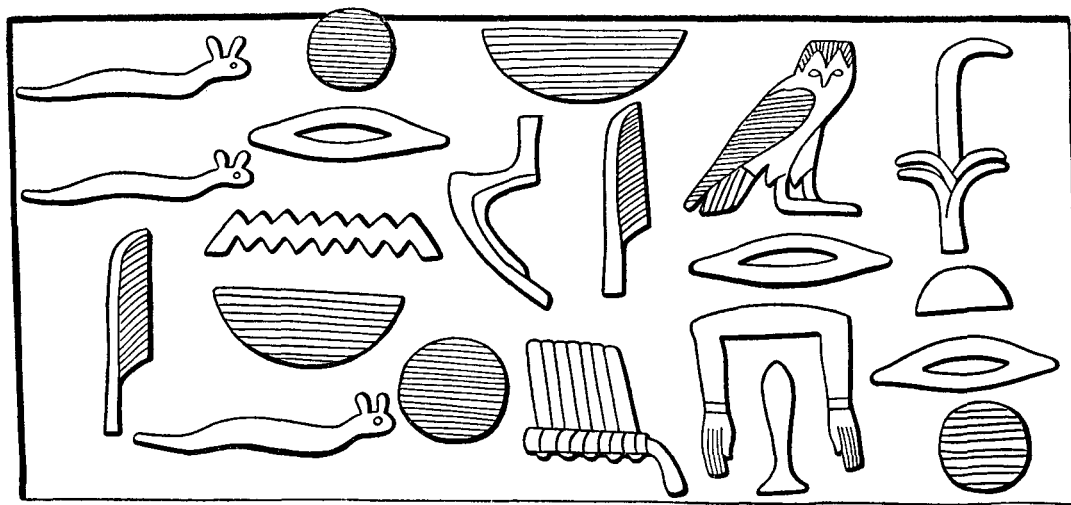

FIG. 168. Inscription on Drum of Doorway.

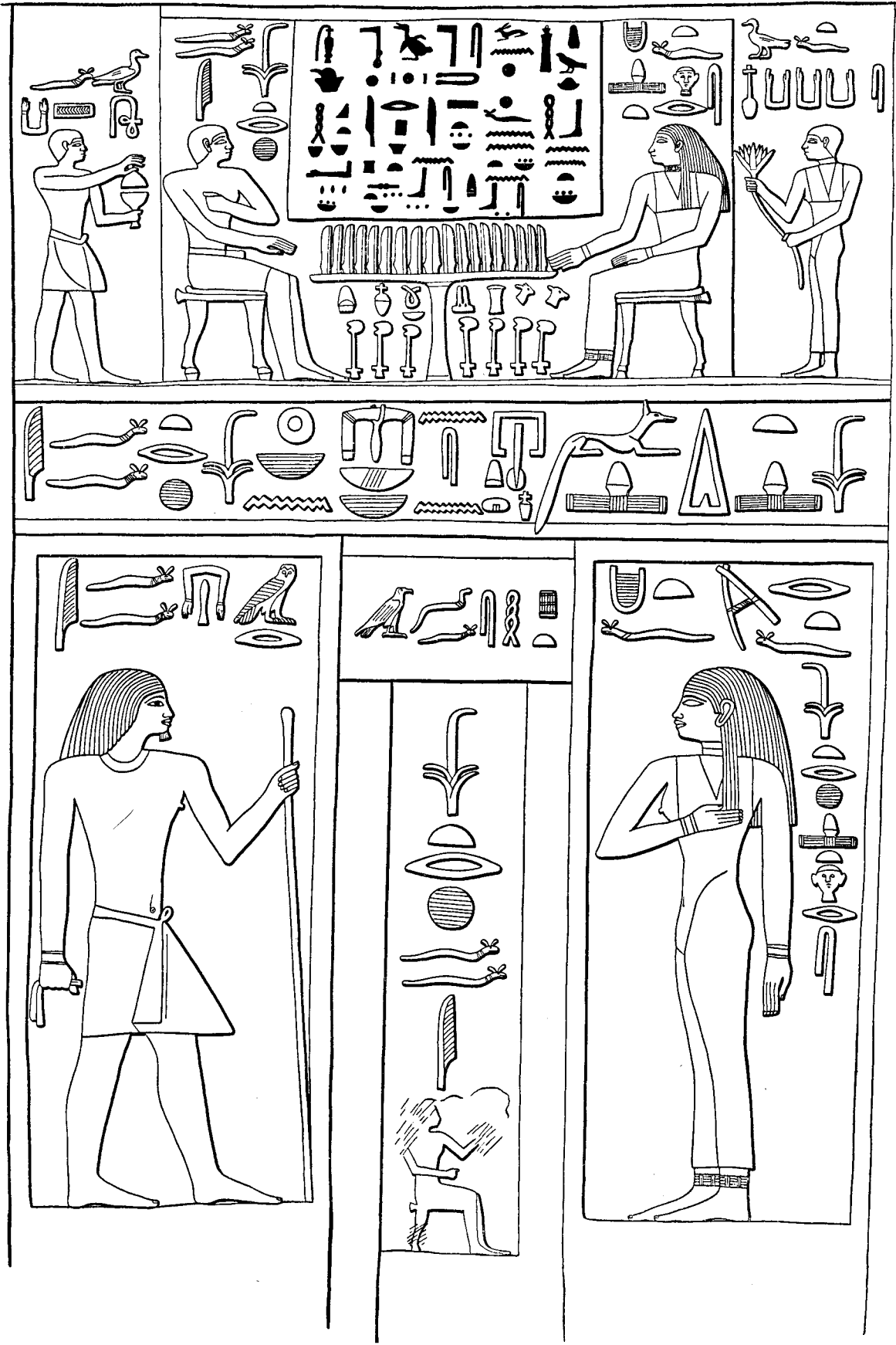

FIG. 169. Inscribed False-door of Fefi.

Ka-servants, the Honoured Master of his Lord, Fefi'. The socket of the door is still visible behind the left jamb. The entrance to the chamber was found blocked by a wall of stone built in later times, possibly to protect an intrusive burial. The doorway gives access to a long, narrow, roofed chamber, 9.30 ms. long by 1.15 ms. wide. The roof consisted of eleven limestone slabs; nine remain in place, two have fallen. In the right-hand wall, at a distance of 2.85 ms. from the entrance, is a small uninscribed false-door composed of two slabs of white limestone raised 90 cms. above the floor. Near the end of the right-hand wall is a second false-door (Pl. LX). This is of

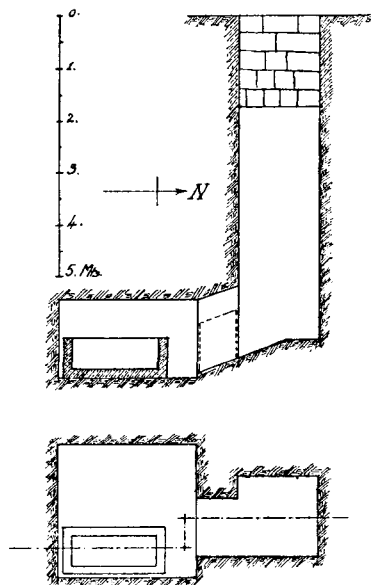

FIG. 170.

Turah limestone. Its outer lintel and jambs are uninscribed. The inner part is sculptured with scenes in relief and inscriptions partly in relief and partly incised (see fig. 169). The slab above the inner false-door is sculptured with a scene of offerings. In the centre is the offering-table carved in relief, but the offering-list above it is incised. On the left-hand side of the table Fefi is represented seated on a chair; on the right-hand side is figured his wife Hetepheres also seated on a chair. Behind Fefi stands his son Weshka burning incense in a censer. Behind Hetepheres stands the daughter Neferkaues holding a lotus-flower with a long stalk. Below this sculptured slab is a lintel with a horizontal line of hieroglyphs in relief, reading 'A boon which the King gives, and a boon which Anubis gives; that the voice (of the offerer) may go forth for them with bread and beer in every festival and every day to the One concerned with the King's Affairs, Fefi'. Beneath the lintel is figured the drum and upon it is inscribed in relief the name Ptahsezefa. On the left-hand jamb is a figure of 'the Overseer of the *Ka*-servants, Fefi' sculptured

in relief; he is represented in the attitude of walking with the left leg thrust forward. He wears a wig and is clad in a loin-cloth pointed in front; around his neck is a necklace and on his right wrist a bracelet. In his left hand he holds a long staff, and in his right a handkerchief. On the right-hand jamb, sculptured in relief, is a figure of 'His wife, his beloved, She who is concerned with the Affairs of the King, Hetepheres'. She is represented standing with her right hand raised to her breast; her left arm hangs down by her side. She wears a long wig and a long tight-fitting garment reaching to near the ankles. Around her neck is a collarette; on her wrists are bracelets, and around her ankles, anklets. The door consists of a single panel; on it is sculptured in relief Fefi's name and title; here, after the name Fefi, is his seated figure.

The Serdab itself contained no trace of any statue and was used in later times as a burial-place. Between the roof and the inner wall of the chamber is a rectangular window for light.

SHAFT. The Shaft of Fefi (fig. 170) measures 1.45 ms. by 1.50 ms. at the top and it is sunk in the rock to the west of the chamber. It goes down 5.58 ms. through the native rock and leads to the Sarcophagus chamber, which is cut on the southern side of the shaft and is rectangular in shape; it contains the sarcophagus of fine white Turah limestone (Pls. LXI-LXV). The lid was found lying on its side to the right of the sarcophagus buried beneath a heap of stones. The Sarcophagus had been plundered in ancient times and was filled to the brim with debris, on top of which was a decomposed skeleton. Among the stones by the lid was found a damaged head of a white limestone statue, and three more pieces of the same statue were discovered while

clearing the shaft (Pl. LIX, 2). The sides and ends of the sarcophagus are elaborately sculptured to represent the four sides of a rectangular palace (Pls. LXI-LXV). Such decoration is not unusual for sarcophagi of the Old Kingdom, but here there is shown an additional detail; the hoops and cords binding the mats that were stretched between the wooden pilasters are represented.¹ At the ends of each of the two sides of the sarcophagus there are inscriptions in relief:

1. 'A boon which the King gives and a boon which Anubis in front of the divine booth gives, (namely) the very good burial for Ptahsezefa in what he made for himself.'

2. 'A boon which the King gives and a boon which Anubis, Lord of the Sacred Land, gives, (namely) the burial of Fefi in the place and in honour with the god and men.'

3. 'A boon which the King gives and a boon which Anubis in front of the divine booth gives, (namely) the burial in the land of the west, he being grown very old as a possessor of honour with the Great God, Fefi.'

4. 'A boon which the King gives and a boon which Anubis, Lord of the Sacred Land, gives, that the voice (of the offerer) may go forth for bread, beer, cakes, oxen, and fowl, in the necropolis in every festival of thine (?), every day in honour with the God, Ptah(se)zefa.'

THE MASTABA OF IY 

FIG. 171. Plan of the Mastaba of Iy.

This Mastaba is situated to the south of the Mastabas of Fefi and Weser, and east of that of Imby (see General Plan). It is composed of two chambers built of local limestone blocks, with its

¹ Compare Quibell, *The Tomb of Hesy*, Pls. VIII and IX.

façade facing south. The jambs of the entrance doorway are broken off at about half their height and the lintel which they supported was found lying on the ground in front of the entrance (Pl. LXVI). This lintel is inscribed with two horizontal incised lines of hieroglyphs (fig. 172) reading ←

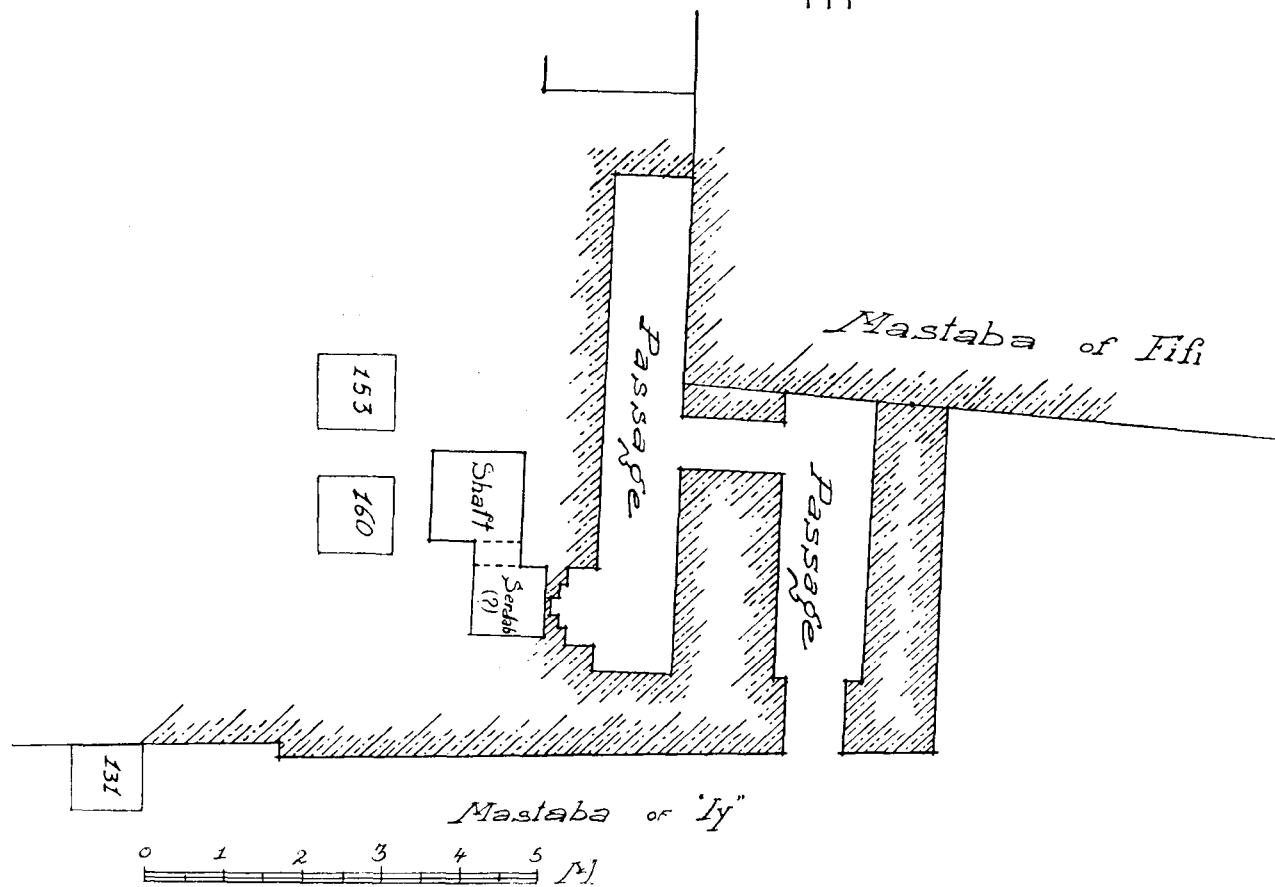
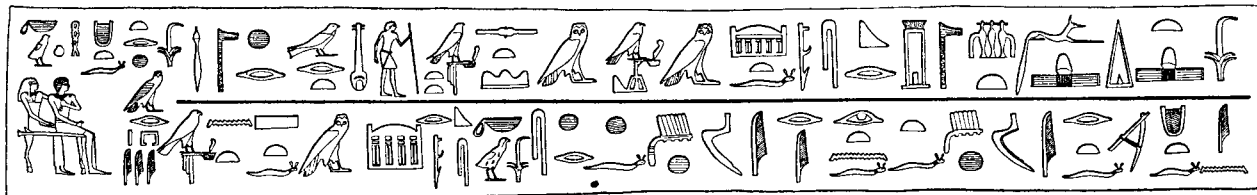





FIG. 172. Lintel of Entrance Doorway to the Mastaba of Iy.

(1) 'A boon which the King gives, a boon which Anubis presiding over the God's Dwelling (gives), that he may be buried in the necropolis of the West (after) having reached a very good old age (honoured) by the Great God; (2) It is his beloved wife, whom he honoured, who made it (i.e. the tomb)—because he was honoured by her—when being buried in his tomb of the west; the One concerned with the Affairs of the King, the Steward, Iy (and) his wife Heknu'.

The door was composed of one leaf and opened inwards; the socket is still intact. This door gives access to a narrow chamber, in the western wall of which is a small uninscribed False-door. Beyond this is an opening in the western wall that gives access to a long narrow chamber; the lintel and jambs of the doorway are not inscribed. This second chamber measures 6.40 ms. by 95 cms. by 2.60 ms. high, and it has two False-doors on its western wall. The first, or northern one, measures 1.75 ms. by 70 cms., and is not inscribed. The second (fig. 173) is larger with an outer lintel and panel of white limestone; the jambs and drum are of local stone.

The inscription upon the lintel reads ←: (1) 'A boon which the King gives, a boon given to Anubis presiding over the God's Dwelling, that he may be buried in the Western Desert after a very good and long old age, the possessor of honour before the Great God, the One concerned with the Affairs of the King, the Steward, Iy (and) his beloved wife Heknu', (2) That offerings may come forth to him at the voice at the Festivals of the New Year, of the Opening of the Year, of Thoth, of W3g, the Great Festival, the Feast of the Epiphany of Min, the Feast of   , and the Feasts of every Month and Half-month, and every Day; the Steward Iy'. At the end of these two lines of inscription Iy and his wife are represented seated before a Table of Offerings. In the Panel below the Lintel was a scene of Iy and his wife seated before a Table of Offerings with a list of the offerings above and at the side of the Table. On the right-hand side of the scene is the figure of a man standing and making an offering; behind Iy and his wife are standing figures of two children. Above the scene is an inscription reading ←: 'A boon which the King gives, a boon of Anubis, that offerings may come forth at the voice to him, that there may be offered offerings every day for the One concerned with the Affairs of the King, the Steward Iy; his wife, possessing honour, Heknu, made it for him'. Below the scene is another horizontal line of hieroglyphs reading ←: 'A boon which the King gives, a boon of Anubis, Lord of the Sacred Land, that he may be buried in the Western Desert after a good old age, the One concerned with the Affairs of the King, Iy; his wife Heknu'. On the right- and left-hand sides of the Panel, that is on the upper part of the outer jambs of the False-door, are figures of Iy and his wife with their names and titles above them. On the outer jambs below the figures of Iy and his wife are (1) on

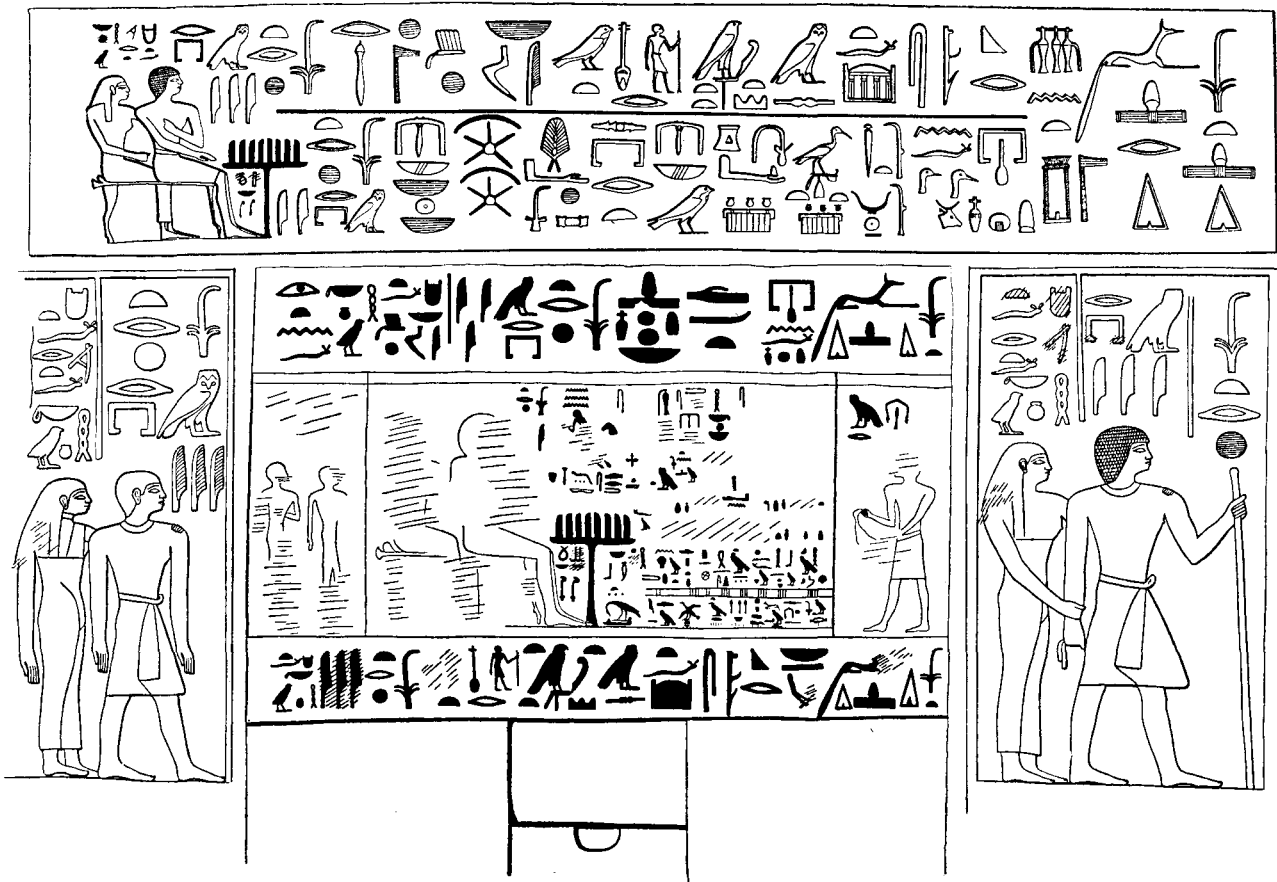

FIG. 173. Upper part of the False-door in the Mastaba of Iy.



FIG. 174.



FIG. 175.

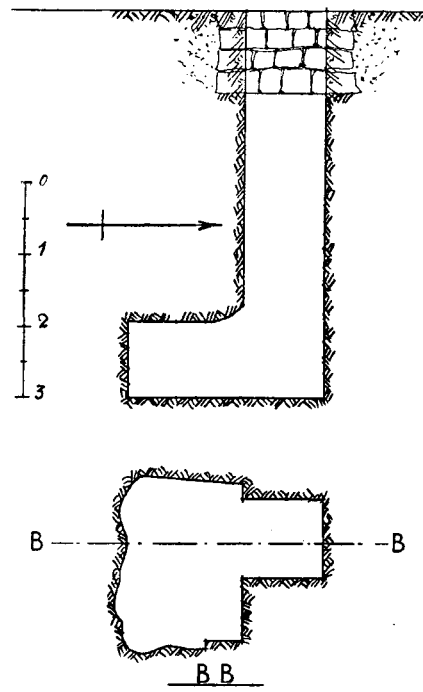

FIG. 176.

the southern jamb, a man figured in relief (fig. 174), facing→ and offering incense in a censer which he holds in his left hand; above him is incised an inscription reading 'His eldest son Inefert'; (2) on the northern jamb, a man figured in relief (fig. 175), facing← and holding a scribe's palette in his left arm-pit, and reed-pen over his ears; his name and titles, which were in front of him, have been weathered away.

Immediately behind the inscribed False-door is a Serdab but no Statuette was found in it. It had been re-used in ancient times as a burial-place.

Shaft. This is situated immediately to the north of the Serdab and is 5.40 ms. deep with a small sarcophagus chamber at bottom cut in the southern side. Contents: a few scattered human bones.

MASTABA OF MERSU-ANKH

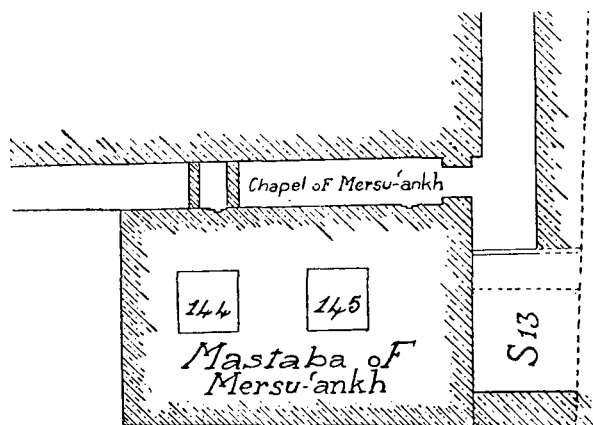
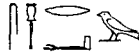

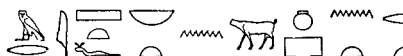



FIG. 177. Plan of the Mastaba of Mersu-ankh.

TITLES OF MERSU-ANKH

1.  'Companion of Re-wer'.¹
2.  'Overseer of the Young Men of the Palace'.¹
3.  'Overseer of all his (Re-wer's) properties in the Interior and those which are in the Exterior'.
4.  'Inspector of the *Ka*-servants'.
5.  'The Beautiful Youth'.

¹ Professor Junker suggests that these titles should be read 'The Overseer of the Young Men of the Estate of the Companion Re-wer'.

FAMILY OF MERSU-RANKH

Mother. Rudsaues with title 'Overseer of the Weavers of the Palace'.

Eldest daughter. Ii-mert.

Younger Daughter. Hathor-wer.

Sons: (1) Khnem-hes-ef.

(2) Ptah-nefer-seshem.

Other people named in the tomb whose relationship to Mersu-rankh is not specifically mentioned.

Iti.

Per-rankh-es.

Khenu.

Per-en-neb.

THE Mastaba of Mersu-rankh is built on a slope of the native rock in the north-west corner of the path leading to Serdab No. 13 of Rer-wer (see General Plan). It measures on the outside 5.45 ms. by 3.45 ms. by 2.35 ms.



FIG. 178. Lintel.

The Chapel is a narrow chamber (3.60 ms. by 0.68 m. by 2.05 ms.) with entrance (1.45 ms. by 0.58 m. by 0.45 m.) to the south. The lintel and jambs are of local yellowish limestone. The threshold, elevated about 45 cms. above the floor of the pathway, is composed of two slabs of local stone. On the lintel (1.05 ms. by 0.45 m. by 0.35 m.) the owner of the tomb is represented three times, in three different attitudes, facing → (Pl. LXVII and fig. 178). On the right-hand

¹ This sign represents a weaver; see fig. 184.

side he is shown with left leg thrust forward, arms hanging down his sides with hands open, and wearing a short plain loin-cloth. The head of the figure has weathered away and in front is a vertical column of hieroglyphs reading '[Overseer] of the Young Men of the Palace, Mersu-ankh'. In the second figure he is represented with left leg forward and clad in a long kilt pointed in front; on his neck is a necklace; in his right hand he holds a $\frac{1}{2}$ -baton, and in his left a long staff. Before him is a vertical column of hieroglyphs reading '[The Honoured one] before the Great God, Mersu-ankh'. The third figure shows him leaning upon a staff, with left leg forward, and clad in a long kilt pointed in front but not as large as that of the second figure. The right hand is raised and rests upon the top end of the staff, the left arm hangs down over the staff. Before this figure is a vertical column of hieroglyphs reading '[The Inspect]tor of the *Ka*-servants, Mersu-ankh'; behind it there is another vertical column reading '[The Honoured one] before his Lord, Mersu-ankh'.

On the jambs are two identical columns of hieroglyphs (see fig. 179) reading: $\downarrow \rightarrow$ 'The Overseer of the Young Men of the Palace, the Inspector of the *Ka*-servants, the Honoured One before the Great God, the Beautiful Youth, Mersu-ankh'.

On the thickness of the jambs on either side the owner of the tomb is represented in a walking attitude as if coming out of the chapel (figs. 180, 181), his arms hang down at the sides with the hands open. He wears a short kilt, a necklace of three bands coloured green, and a wide loin-cloth pointed in front. The knot of the girdle which secures the loin-cloth is green. The body is coloured dark red. Above his head and in front of his face are incised his name and titles: the hieroglyphs are coloured green.

The right and left walls of the Chapel are built of six courses of local stone. The floor is cut in the native rock. On the western wall near the entrance is an inscribed false-door built of four slabs of Turah limestone (see fig. 182). The inscription on the lintel reads \rightarrow : 'A boon that the king gives and Anubis Presiding over the God's Dwelling; that he be buried in the Necropolis after old age, Mersu-ankh, loving life'. On the outer jambs of the false-door are two vertical columns of hieroglyphs. That on the left reads $\leftarrow \downarrow$: 'The Companion of Re-wer eternally,¹ the Overseer of the Young Men of the Palace, the Overseer of all his (Re-wer's) properties in the interior and those which are in the exterior, Mersu-ankh.' That on the right reads $\downarrow \rightarrow$: 'The Companion of Re-wer,² I am his Honoured One more than any of his men. It is I, the Honoured One of the God (and) the Honoured One of his Master who did not commit anything against any man.'

On the panel above the entrance of the false-door the owner of the tomb is represented seated on a chair before an offering-table. Mersu-ankh's body is here coloured green, his wig is black, and the chair and offering-table is painted green over black. Above is his name with title, and the hieroglyphs for 'bread, beer, geese and oxen' with the numeral '1000' below each. On the inner lintel beneath this scene Mersu-ankh's name with title is repeated. On the inner jambs of the false-door are figures of Mersu-ankh's family; all the figures are painted green. On the left-hand jamb are three figures arranged one above the other facing \rightarrow . The uppermost is Mersu-ankh's mother Rud-sua-es; the second is a male named Iti; the third a female named

¹ Professor Junker would read 'the Overseer of the Young Men of the Estate of the Companion Re-wer'.

² Professor Junker would read 'I am honoured by the Companion of Re-wer more than all his people'.

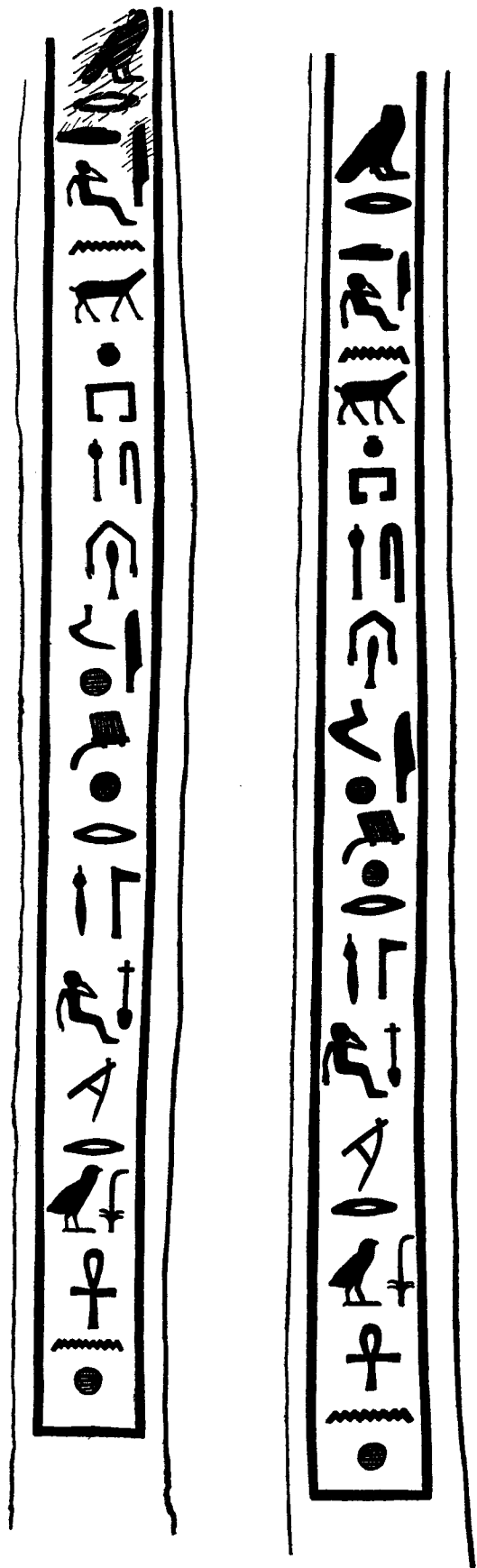

FIG. 179. Jambs.

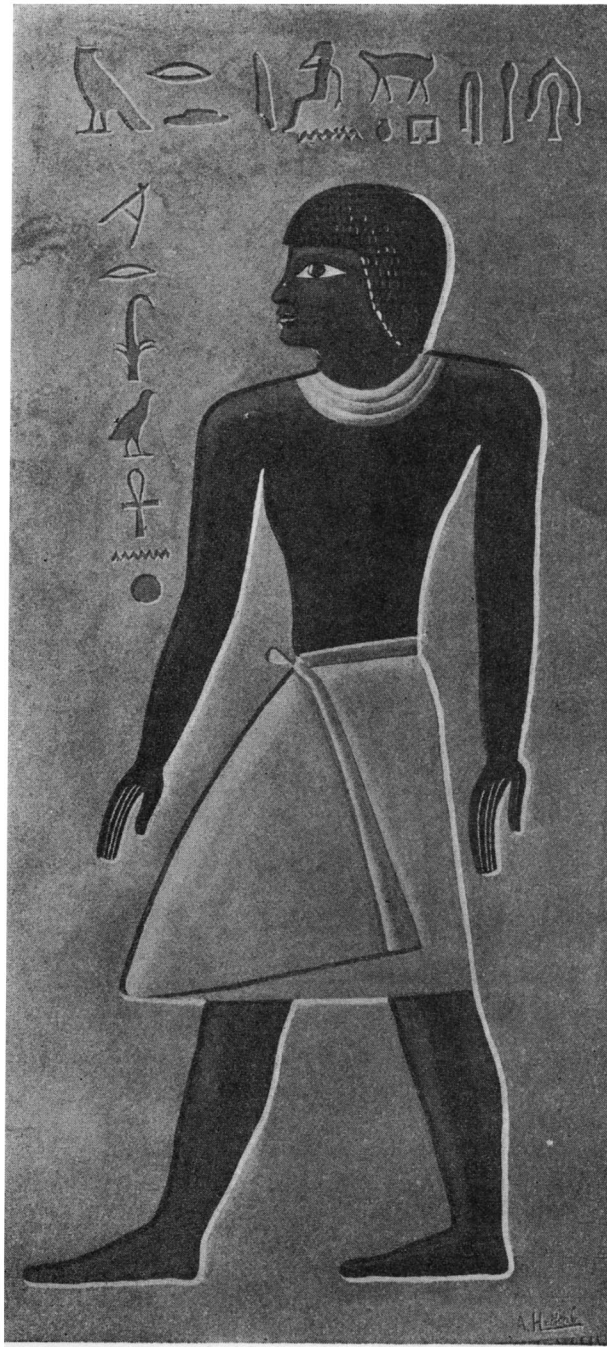

FIG. 180.

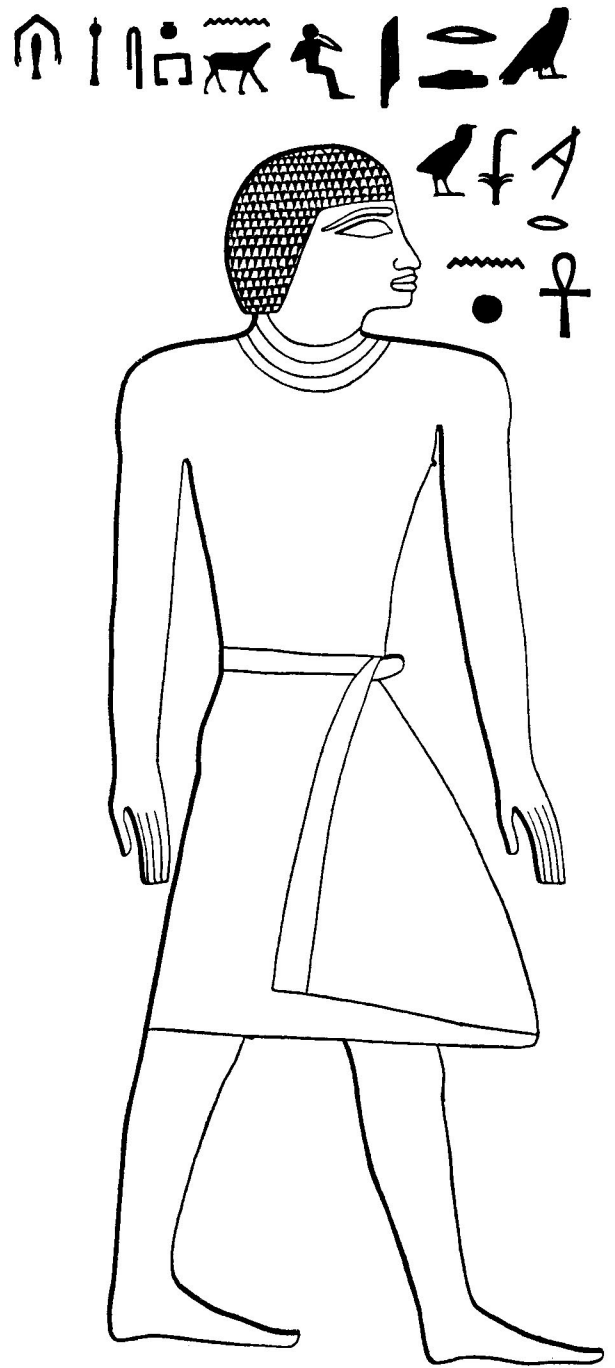

FIG. 181.

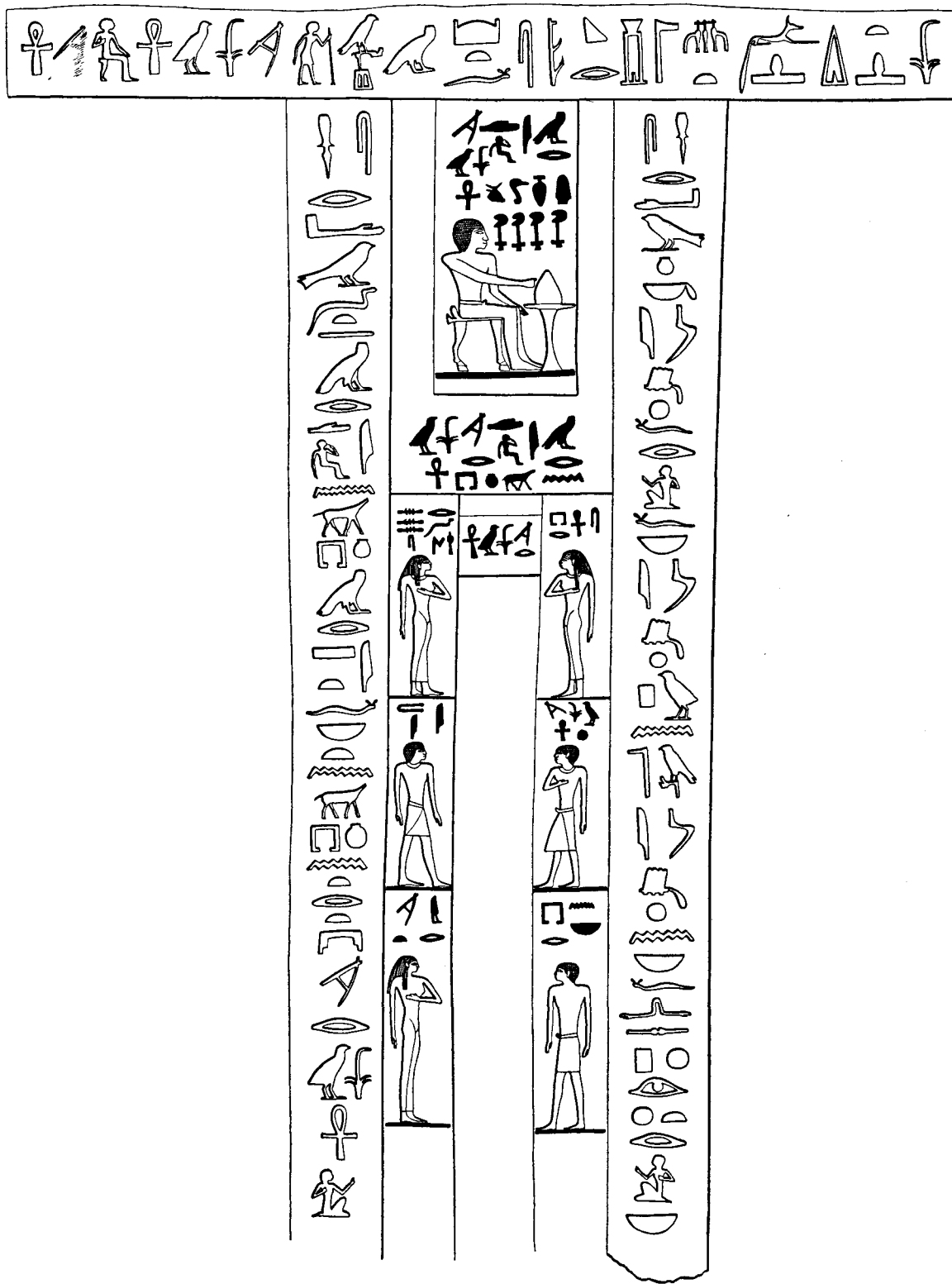

FIG. 182.

Ir-mert. On the right-hand jamb are also three figures arranged one above the other facing ←. The uppermost is a woman named Per-rankh-es; the second is Mersu-rankh himself; and the third a man named Per-en-neb. On the drum between the jambs is the name 'Mersu-rankh'. The lower part of these jambs is painted black.

In front of the false-door were found four inscribed offering-tables. The first two were placed one above the other (Pl. LXVIII, 1); the other two were found lying side by side.

OFFERING-TABLE NO. 1 (Pl. LXVIII, No. 2). White limestone, measuring 35.50 cms. by 26.50 cms. by 10.50 cms. Rectangular in shape with two equal rectangular basins narrowing from top to bottom; one is for beer, the other for water. The work is good and the offering-table complete. *Inscriptions*: Four incised lines of hieroglyphs around the upper surface of the table and one vertical column down the centre:—

Top. ← 

Right side. ←↓ 

Bottom ← 

Left side. ←↓ 

Centre ←↓ 

(Top) 'A boon that the King gives, a boon of Anubis Presiding over the God's Dwelling; his burial in the Necropolis of the Western Desert', (Right side) 'that offerings may come forth for him at the Voice in the Feast of Thoth, the Feast of *W'g*', (Bottom) 'in the Monthly and Half-monthly Feasts, in every festival every day, the Honoured One before the Great God', (Left side) 'the Overseer of the Young Men of the Palace, the Inspector of the *Ka*-servants Mersu-rankh', (Centre) 'the beloved one of his Lord, the adolescent, Mersu-rankh'.

OFFERING-TABLE NO. 2 (Pl. LXIX, No. 3). White limestone, measuring 26 cms. by 19.50 cms. by 10 cms. Rectangular in shape with one rectangular basin narrowing from top to bottom. The work is good and the table is complete except for slight weathering of the inscription in the top left-hand corner. *Inscriptions*: Four incised lines of hieroglyphs around the upper surface of the table:—

Top. ← 

Left side. ←↓ 

Right side. ↗ 

Bottom. ← 



(Top) 'A boon that the King gives, a boon of Anubis, that offerings may come forth for him at the Voice in every Monthly and Half-monthly festival', (Left side) 'the Overseer of the Young Men of the Palace', (Right side) 'the Inspector of the *Ka*-servants Mersu-rankh', (Bottom) 'A

thousand offering-tables, a thousand loaves of bread, jars of beer and delicacies, a thousand oxen, geese, and oryxes (and) fine linen and alabaster tables, Mersu-rankh'.

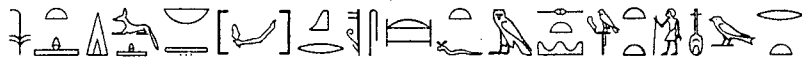
OFFERING TABLE NO. 3 (Pl. LXIX, No. 4). White limestone, measuring 48 cms. by 31.50 cms. by 12 cms. Rectangular in shape with a rectangular basin narrowing from top to bottom. The work is fair but the surface has much flaked away and a great part of the inscription is lost. *Inscriptions*: Four incised lines of hieroglyphs around the upper surface of the table.

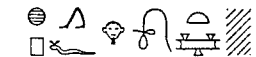
Top. ← 

Right side. ←↓ 

Left side. ←↓  Bottom. ← 

OFFERING TABLE NO. 4 (Pl. LXIX, No. 2). White limestone, measuring 22 cms. by 11 cms. by 5 cms. A rectangular slab finely cut with a rectangular basin narrowing from top to bottom at one end and a circular table in relief with two smaller circular depressions having raised rims (one chipped) at the other end. *Inscriptions*: Three lines of incised hieroglyphs giving the name and titles of Mersu-rankh:—

1. ↓  2. ←  3. ← 

At the extreme northern end of the chapel are two serdabs, one at a higher level than the other. The southern wall of the upper one is built on the northern wall of the lower. The aperture of the lower serdab is rectangular in shape and measures 4 cms. by 20 cms. Above it are two horizontal lines of hieroglyphs (fig. 183).

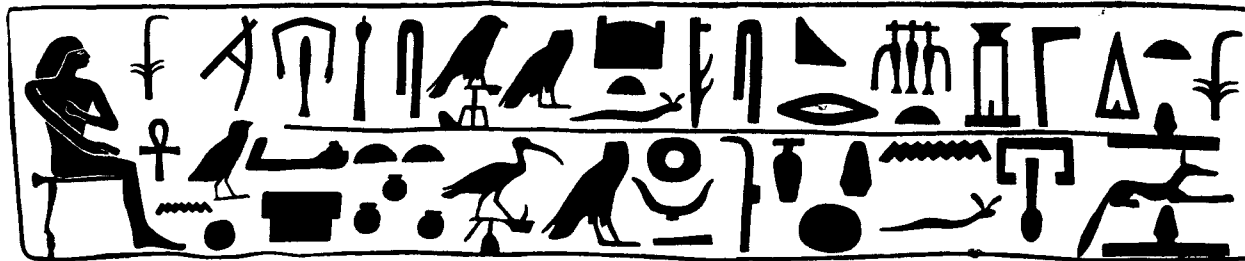

FIG. 183.

(1) 'A boon that the King gives and Anubis Presiding over the God's Dwelling: his burial in the West, (2) that offerings come forth to him at the Voice at the Opening-day-of-the-Year Feast and at the Feast of Thoth, the Inspector of the *Ka*-servants Mersu-rankh'.

At the end of the inscription Mersu-rankh is figured seated on a chair: he is coloured green over a wash of black.

In the left-hand wall of the chapel is a false-door (Pl. LXIX, 1 and fig. 184); this is of white limestone. Only the upper part of it (about 65 cms.) was visible when the tomb was opened; the lower part was hidden by the serdab wall. This false-door was dedicated by Mersu-rankh to his mother Rud-sau-es. On the lintel are two lines of hieroglyphs reading ←: (1) 'The Overseer of the Young Men of the Palace, Mersu-rankh'; (2) 'His Mother, the Overseer of the Weavers (of the Palace) Rud-sau-es'.

Right-hand jamb: a vertical column of hieroglyphs reading \downarrow , 'The Overseer of the Weavers of the Palace, the Honoured One before the Great God, Rud-sau-es'.

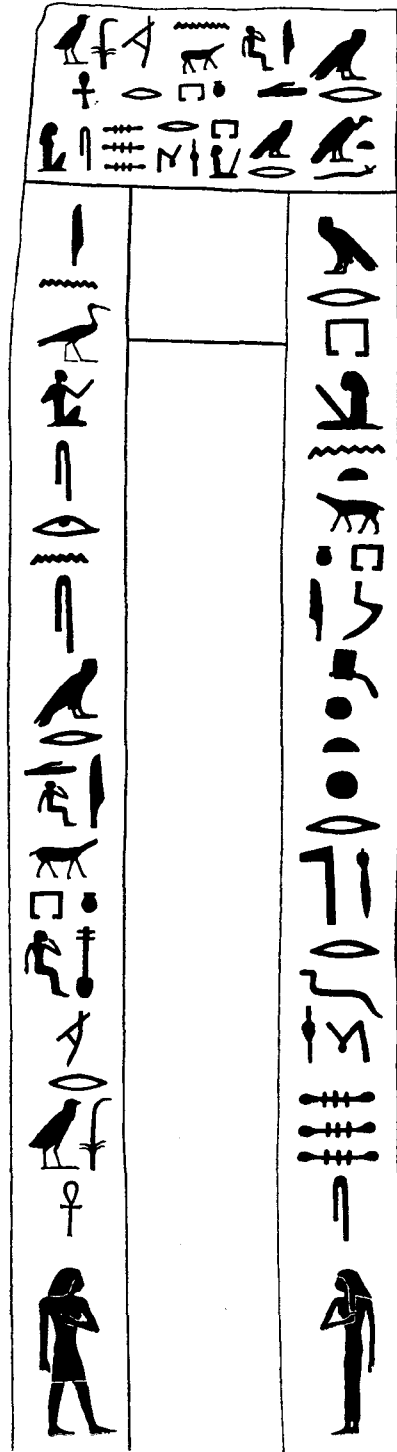

FIG. 184.

Left-hand jamb. $\leftarrow\downarrow$, 'It is her Son who made it (*i.e.* the false-door) to her, the Overseer of the Young Men of the Palace, the \downarrow , Mersu-rankh'.

In the northern wall of the lower Serdab, the aperture of the upper one is visible. It is situated in the middle of the wall at about 57 cms. from the ceiling of the lower Serdab. This aperture (40 cms. by 5 cms.) is nearly twice as large as the aperture of the lower Serdab. This may be explained by the number of statuettes that were found in the Serdab.

The surface of the southern wall of the upper Serdab—i.e. that in which the aperture exists—is divided into three parts (see fig. 185). The uppermost contains a horizontal row of large

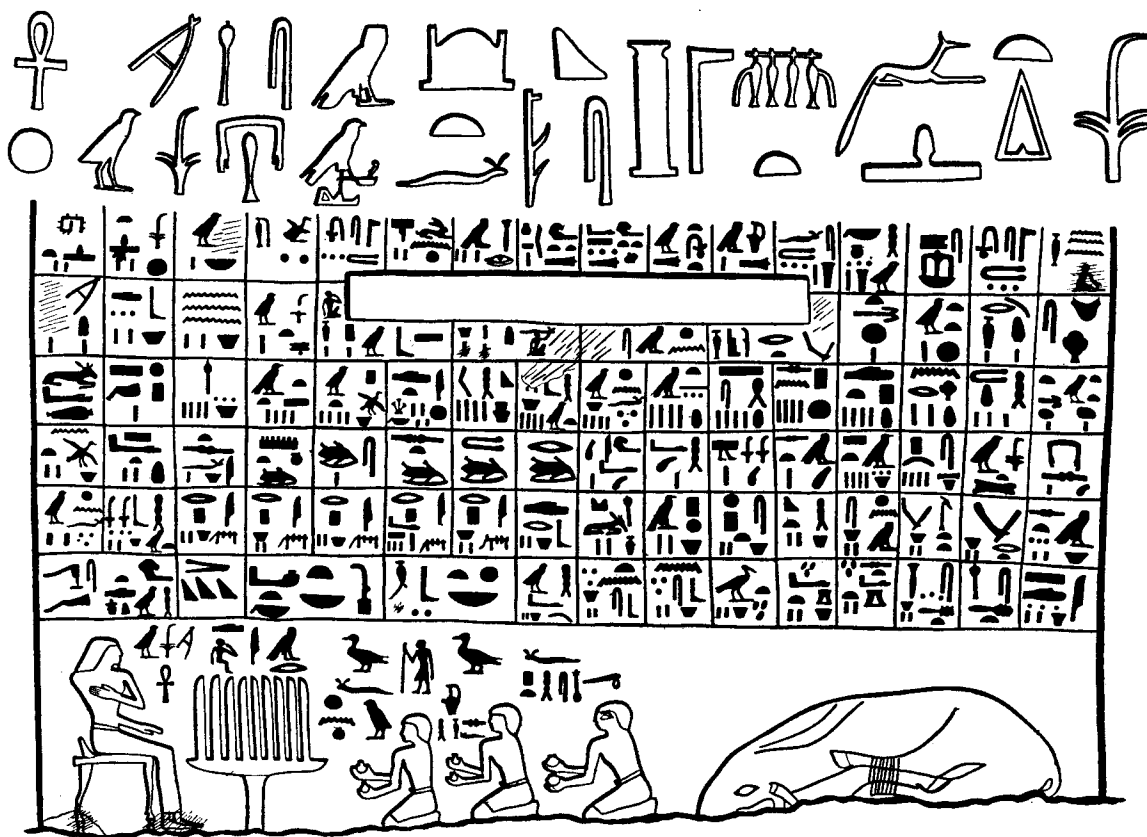

FIG. 185. Southern Wall of the Upper Serdab.

hieroglyphs reading: 'A boon which the King gives, a boon which Anubis, Presiding over the God's dwelling, (gives), that he may be buried in the west, the Inspector of *Ka*-servants, Mersu-rankh.' The second part contains a long list of offerings. In the lower part is a representation of Mersu-rankh seated before a table of offerings. Before him and over the offering-table is a horizontal line of hieroglyphs reading: 'The Overseer of the Young Men, Mersu-rankh.' Before the offering-table are figured three sons: (1) 'His eldest son, Khenu'; (2) 'His son, Hesef-Khnum'; and (3) 'His son, Ptah-nefer-seshem'. Behind these figures is a bull bound ready for sacrifice.

SHAFTS.

No. 144 (fig. 186), measuring 1 m. by 1 m. by 3.60 ms. in depth. The burial chamber is to the west and measures 1.50 ms. by 1.10 m. Contents: some broken human bones.

No. 145 (fig. 187), measuring 1 m. by 1 m. by 7.40 ms. in depth. The burial chamber, cut in the rock directly under Serdab No. 13 of *Re-r-wer*, is 1.50 ms. by 1.50 ms. The burial chamber is to the

west and its floor is sunk 60 cms. below the bottom of the shaft. Contents: Among the debris filling the shaft were found the statuette of Mersu-rankh No. 4 (see Pl. LXXVI), the pedestal of a statuette of a man (Pl. XXI, p. 20), and the pedestal of a triple group of Re-rwer (Pl. XXII, p. 21).

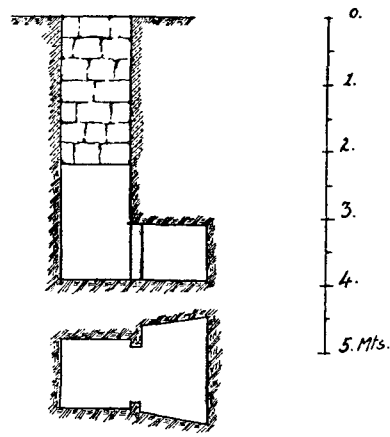

FIG. 186.

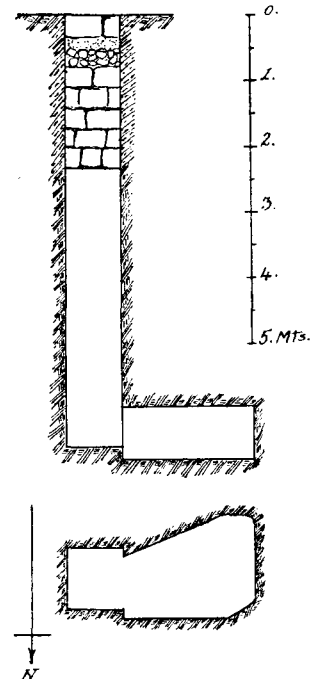

FIG. 187.

SERDAB NO. I. TRIPLE STATUETTE.

No. 1. Group of three figures all representing Mersu-rankh (Pl. LXX). Limestone, painted. Height 65 cms., breadth 57 cms. The standing figure on the right is 56 cms. high and 17 cms. across the shoulders; the central figure is 57 cms. by 20 cms. across the shoulders; the figure to the left is 56 cms. high by 20 cms. across the shoulders. The work is good and the preservation excellent. Two of the figures of this group are seated, the third is standing with his left leg forwards. It is probable that these three figures represent Mersu-rankh at different periods of his life; the standing one shows him as a youth, the central one as a full-grown man, and the third in old age. The standing figure wears a black close-fitting wig which hides the ears, and round his loins is a loin-cloth with one side crimped. His arms hang at his sides and the hands are closed over a \square . Both the seated figures have long wigs falling behind the shoulders and covering the upper part of the ears. The natural hair of the central figure is visible on the forehead, but the hair of the third is entirely hidden under the wig. The eyebrows and lashes of all three statuettes are coloured black, and all three have their eyes very wide open. Each wears a broad necklace, painted green, but that of the third differs from the other two in having three pairs of beads, one in the middle, the other on each side of the shoulder. The hands of each of the seated figures rest on the thighs; the left hands are open and lay flat on the loin-cloths; the right hands are closed and hold handkerchiefs. Both wear the loin-cloth with pleated end; the pleated part is painted red, the rest white. The girdle on all the three figures is green; the bodies are painted red. The spaces between the arms and sides of the bodies, and between the legs are coloured

black. Three vertical lines of hieroglyphs are incised down the fronts of the chairs and continued on the top of the pedestal. These read from right to left.

1. $\leftarrow \downarrow$  ^{sic} ?
2. $\downarrow \rightarrow$  ^{sic} ?
3. $\downarrow \rightarrow$ 

STATUETTE NO. 2.

No 2. 'The Breweress' (Pl. LXXI). Limestone, painted. Height with pedestal 27 cms.; height of figure 24.5 cms.; breadth of shoulders 7.5 cms. The work is realistic and its preservation good except for a fragment broken away from the left leg. It was found facing the triple group No. 1. The woman is represented leaning over a large vase with shallow basket-work sieve on top, stirring the fermenting barley for making beer. Her wig falls upon her shoulders and covers her neck; her natural hair is visible on the forehead. Her eyebrows and lashes are painted black; her cheeks are full. She wears a necklace which is coloured green and white. She has prominent breasts and wears a white robe which covers the lower part of her body, from the navel to a little below the knee. Her body is coloured dark yellow. The shallow basket-work sieve is painted dark yellow and black. The vase is dark red imitating pottery. The pedestal is very roughly carved.

SERDAB NO. 2.

No. 1. Double Statuette of Mersu-rankh (Pl. LXXII). Limestone, painted. Height with pedestal 59.5 cms. Right figure, height 52.5 cms.; breadth across the shoulders, 15.5 cms. Left figure, height 51 cms.; breadth across the shoulders 15 cms. The headdress of the two figures is identical: a short black wig covering the back part of the head and ears. The faces are well sculptured. Both figures wear necklaces, coloured white, green and blue, and white loin-cloths, triangular in front. Both figures also have the left leg forwards but the position of the arms is different. The right statuette has the left arm raised, the hand open and resting on the right side of the chest immediately below the shoulder; the right arm hangs down the side and the hand grasps the \square . In the left statuette the position of the arm is reversed, i.e. the right arm is raised to the left side of the chest and the left arm hangs down at the side. The faces and uncovered parts of the body are painted red. Between the two figures is a plinth reaching up to near the shoulders and the base or pedestal extends beyond the feet. Plinth and pedestal are painted black. On the outer face of the plinth between the arms of the two figures is a vertical line of incised hieroglyphs reading $\leftarrow \downarrow$  . This part of the plinth projects a short distance beyond the lower part. On this lower part there is another vertical line of hieroglyphs which is continued on the pedestal, reading

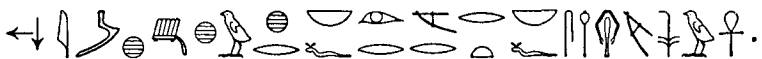
$\leftarrow \downarrow$ 

By the feet of the figures are two vertical lines of hieroglyphs reading $\leftarrow \downarrow$ .

No. 2. Group of a man and a woman, probably Mersu-rankh and his wife (Pl. LXXIII). Lime-

stone, painted. Height with pedestal 50.5 cms.; height of largest figure 46 cms.; breadth across chest 27 cms. These two figures are represented in a standing position; the legs of the man are slightly separated; those of the woman are close together. The man wears a short wig covering the ears and great part of the forehead. His eyebrows and eyelashes are painted black and the pupils of the eyes white. He has a small moustache which is represented by a thin black line. He wears a necklace of seven bands, coloured blue and green alternately. Around his loins is a loin-cloth with one end folded over in front. His arms hang down at his sides and in each hand he grasps a \square . His body is coloured red and the nipples of his breasts are indicated by a black dot. The woman wears a wig reaching to the shoulders and fitting low on the forehead. Her eyebrows and eyelashes are painted black. She wears a necklace consisting of eight bands of blue and green with a row of drop-shaped beads below. She is clad in a long white close-fitting sleeveless garment with shoulder straps. On her ankles are anklets coloured blue, yellow, and black. Her right arm is placed around the man's shoulders, the fingers of the hand appearing over the man's right shoulder. Her left arm hangs at her side with the hand open. Her skin is painted yellow. Behind the figures is a broad plinth and below the feet a pedestal. There are no inscriptions on this group.

No. 3. A group of three figures representing Mersu-rankh and his two daughters (Pl. LXXIV). Limestone, painted. Height with pedestal, 43 cms. These three persons are represented standing; Mersu-rankh is in the centre with his daughters on either side of him. Mersu-rankh's figure is 36.5 cms. high and 9 cms. across the shoulders. He wears a short black wig covering the ears. His eyebrows and eyelashes are black. He wears a necklace consisting of bands coloured blue, green and black, and a white loin-cloth crimped on one side. His arms hang down at his sides and the hands grasp the \square . His left leg is thrust forwards. The colour of his body is red. The taller of the two girls wears a medium length wig spreading outwards down the sides of the face but not reaching to the shoulders; beneath the wig, on her forehead, her natural hair is indicated. The colour of her skin is yellow. Her eyebrows and eyelashes are painted black. She wears a necklace of bands of black, white and blue, and a long close-fitting sleeveless white garment with broad shoulder straps. On her left wrist is a bracelet and on her ankles, anklets. The smaller of the two girls is similarly clad to her sister and has the same yellow-coloured skin, but her arms are differently placed; her left arm enfolds her father's waist and her right forearm is placed across her waist with the open hand resting on Mersu-rankh's right arm. Behind this group is a plinth, and below a pedestal, on which the three following inscriptions are incised:—

In front of the central figure: $\leftarrow \downarrow$  'The Inspector of the *Ka*-servants Mersu-rankh'.

In front of the tallest girl $\leftarrow \downarrow$  'His eldest daughter, Ymert'.

In front of the smaller girl $\leftarrow \downarrow$  'His daughter, Hathor-wer'.

SHAFT NO. 145.

No. 4. Statuette of a Man, probably Mersu-rankh (Pl. LXXVI). Limestone, painted. Height 53 cms. Breadth across the shoulders, 15.5 cms. The man is represented standing with left leg forwards. He wears a short black wig. The eyebrows and eyelashes are black and the pupil of the eye is marked by a white dot in the middle of the black iris. The colour of the skin is red. He

wears a necklace but its colouring has weathered away. The chest and shoulders are broad and the neck thick and short. The arms hang down the sides and the hands grasp the ☐. He is clad in a white loin-cloth with triangular front. The plinth backing the statuette and the pedestal are painted black. There are no inscriptions. A part of the left shoulder was broken off and has been restored.

SHAFT 151.

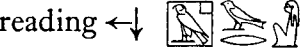
No. 5. Three fragments of a Group of Two Figures representing Mersu-rankh and Hathor-wer (Pl. LXXV). Limestone. Dimensions of the lower part, 18 cms. by 25 cms. Height of the man's head, 10 cms. Height of the woman's head, 11 cms. These two figures were represented standing on a pedestal with a broad plinth at the back; the man has his left leg forwards; the woman has her feet close together. The man wears a close-fitting short wig; the woman a short wig spreading outwards down the sides of her face but not reaching to the shoulders; beneath the wig on the forehead the natural hair is indicated. The torsos of both figures are lost; no trace remains of the loin-cloth of the man, but the legs of the woman are clad in the long close-fitting garment usually worn by women. On the plinth between the two figures is a vertical line of hieroglyphs reading . On the left side of the woman is another vertical line of hieroglyphs reading . The front of the pedestal is curved. These three fragments were found in Shaft No. 151.

NOTES ON THE FLINT IMPLEMENTS FOUND DURING THE COURSE OF THE EXCAVATIONS

BY P. PAUL BOVIER-LAPIERRE, S.J.

(Pl. LXXXI)

1°. Trois éclats de taille (silex); ne semblent pas avoir été utilisés; sans intérêt spécial.

2°. Deux pièces (silex) de Rr-wr. Belles et grandes lames en forme de couteaux à trois facettes sur la face supérieure, à bords tranchants sans retouches (Pl. II, B). Base (côté du bulbe de percussion) retaillée en spatule sur la face supérieure. Extrémité arrondie, retaillée en grattoir caréné sur la face supérieure. Pourraient être des rasoirs non usagés (tranchant parfaitement intact).

3°. Deux pièces (silex). Semblables aux deux précédentes, mais plus massives, à bords plus ou moins émoussés et montrant un poli d'usage, surtout visible sur le bord gauche de la plus grande.

4°. Une pièce (silex). Extrémité supérieure d'une lame de même forme que les deux précédentes, mais montrant en plus des retouches sur le bord droit (face supérieure) ainsi qu'un esquillage d'utilisation sur le bord gauche. Pourrait être un racloir avec grattoir à l'extrémité.

5°. Seize pièces (silex et calcaire siliceux). Éclats minces, étroits et effilés, ordinairement à trois facettes, se terminant en pointe mousse ou aiguë, retouchée ou non. Base retaillée en spatule sur la face supérieure. Bords peu ou pas retouchés, montrant un esquillage d'utilisation et parfois un poli d'usage. Plusieurs pièces brisées.

6°. Cinq pièces (silex) de forme triangulaire, dont une de grandes dimensions, faites avec la base d'un éclat mince et large dont l'extrémité a été retranchée intentionnellement ou non. Face inférieure sans retouches (bulbe respecté). Face supérieure entièrement retaillée, sauf une exception. Extrémité large, retaillée en biseau (légèrement arqué dans un cas), formant un grattoir caréné se terminant à droite et à gauche par une pointe plus ou moins aiguë.

7°. Une pièce (silex), analogue aux grattoirs triangulaires, mais qui en diffère par sa forme allongée, par sa base arrondie en spatule et non taillée en pointe, par l'absence de retaille sur la face supérieure, sauf légères retouches sur les bords.

8°. Cinq éléments de faucilles (silex). Fragments le plus souvent rectangulaires de lames prismatiques, retouchés en dents de scie sur un ou deux bords. Étaient destinés à être fixés sur une monture. Plusieurs montrent un poli d'utilisation très accentué.

9°. Deux racloirs rectangulaires (silex). Fragments de grandes lames coupées à angle droit aux deux extrémités. Face supérieure entièrement retaillée, face inférieure en partie seulement. Ces pièces peuvent être considérées comme constituant à la fois un double racloir et un double grattoir. Trouvées ensemble dans une même tombe de la chambre funéraire. Plutôt 4^{ème} dynastie.

10°. Trois pièces (silex) dites 'couteaux à manche' ou 'à cran' (?). Fréquentes à l'époque prédynastique (par exemple au Fayoum). Une intacte, une brisée en deux morceaux, un fragment. Pourraient être considérées comme des instruments composites, combinaison de racloirs convexes et concaves. Considérées par certains comme ayant servi à l'écaillage des poissons.

11°. Deux fragments (silex) pouvant provenir de 'couteaux à manche' analogues aux précédents.

PLATES



TOMB OF RE'-WER : VIEW OF THE FORECOURT



2

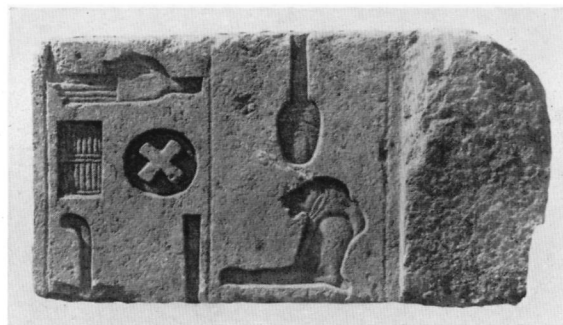

3



4

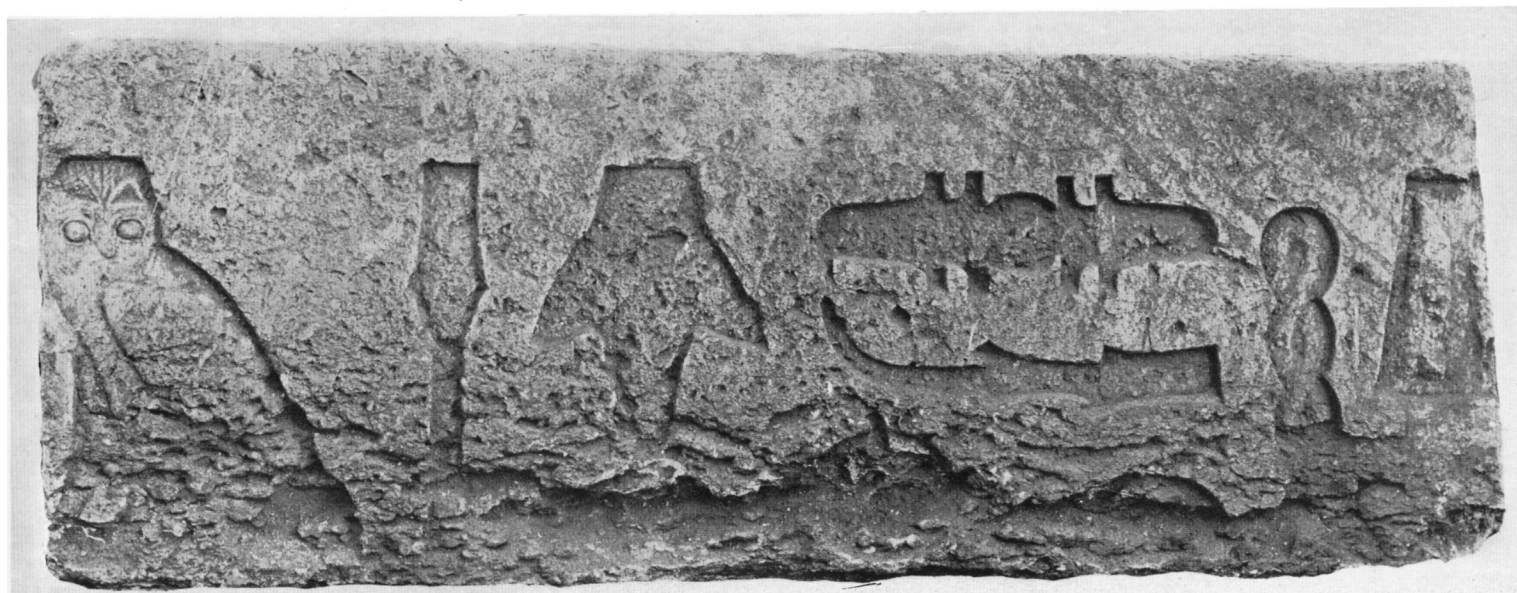

1

TOMB OF RE-WER: FRAGMENTS OF THE LINTEL AND JAMBS



1



2



3

TOMB OF REU-WER: 1 and 2 INSCRIPTIONS ON JAMBS OF PASSAGE DOORWAY AND 3 FRAGMENT OF A SCULPTURED SCENE

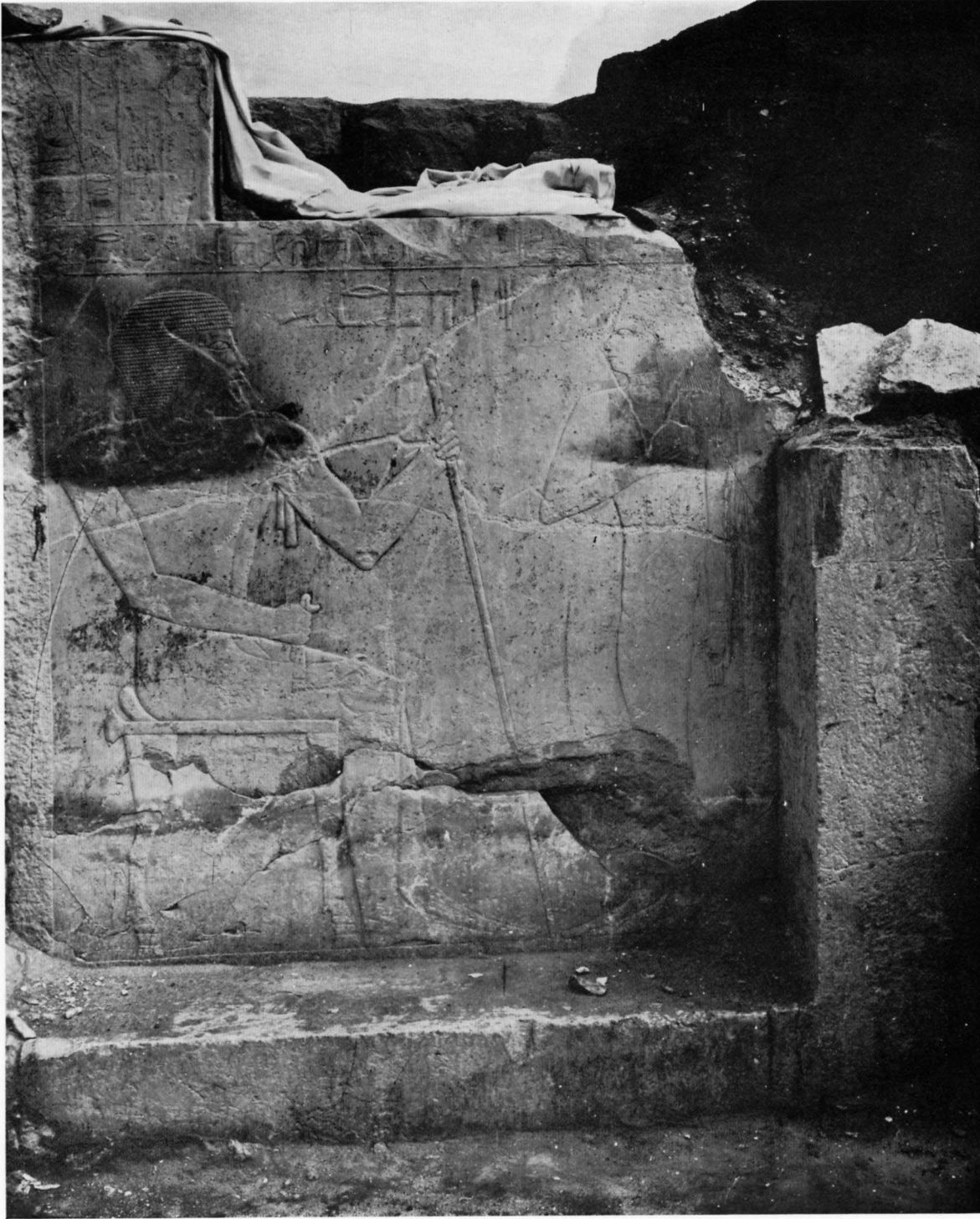

TOMB OF REO-WER: SCULPTURED SCENE OF REO-WER AND HIS MOTHER



TOMB OF RE'-WER: VIEW OF THE OFFERING CHAMBER



A

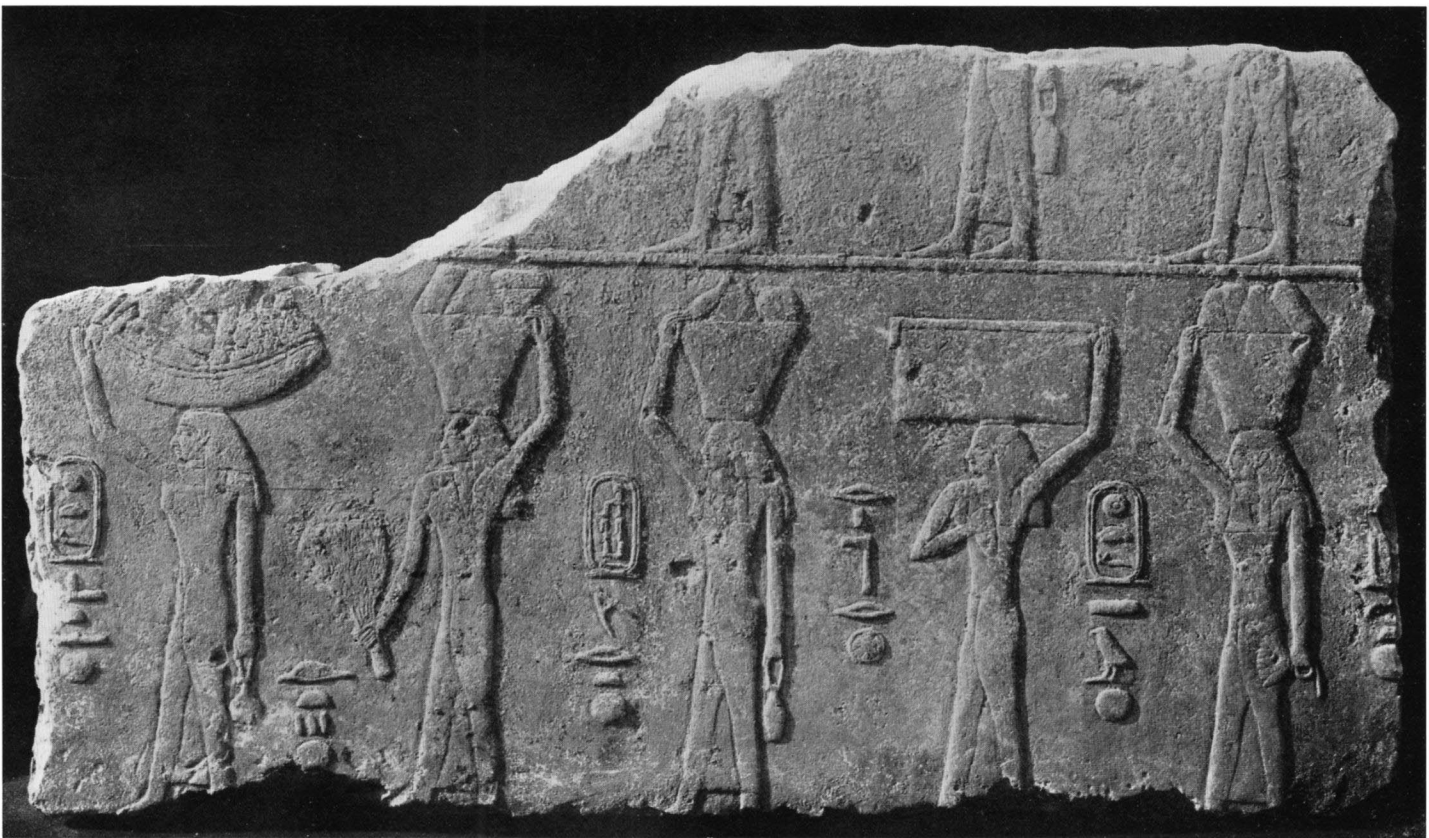

B

TOMB OF RE-WER : SCULPTURED SLABS



I



2

TOMB OF REU-WER: SCULPTURED SLABS

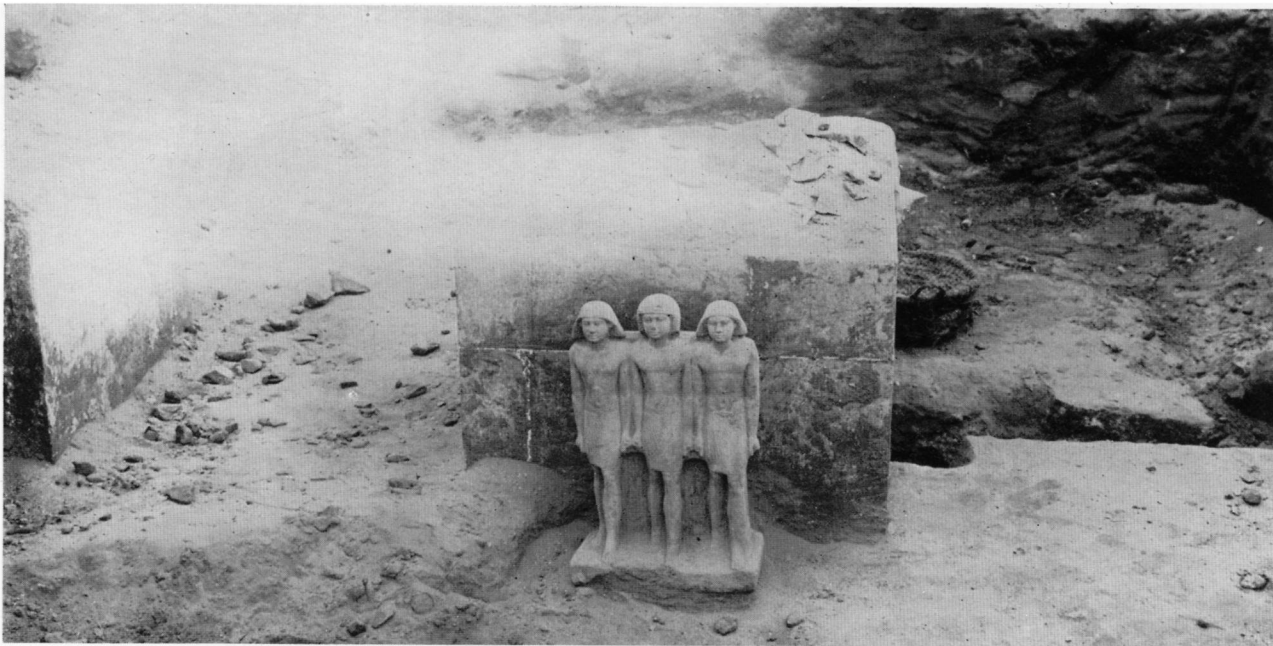

1. TOMB OF RE'-WER: TRIPLE STATUETTE IN PLACE AS FOUND



2. TOMB OF RE'-WER: SCULPTURED SLAB



TOMB OF RE-WER: TRIPLE STATUETTE OF RE-WER

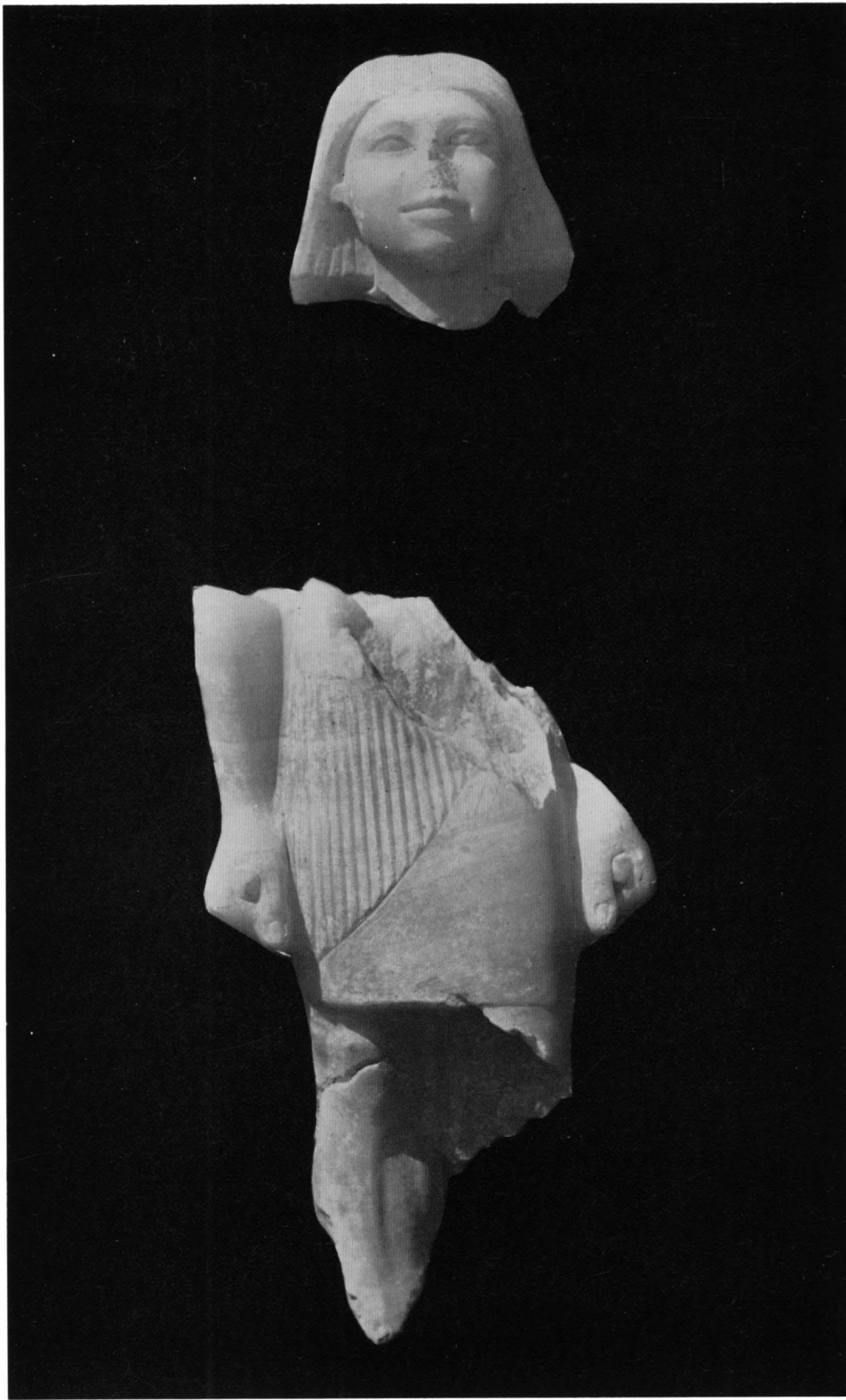

TOMB OF REU-WER: FRAGMENTS OF ALABASTER STATUETTE



I



2

TOMB OF REU-WER : FRAGMENTS OF SCULPTURED SCENES

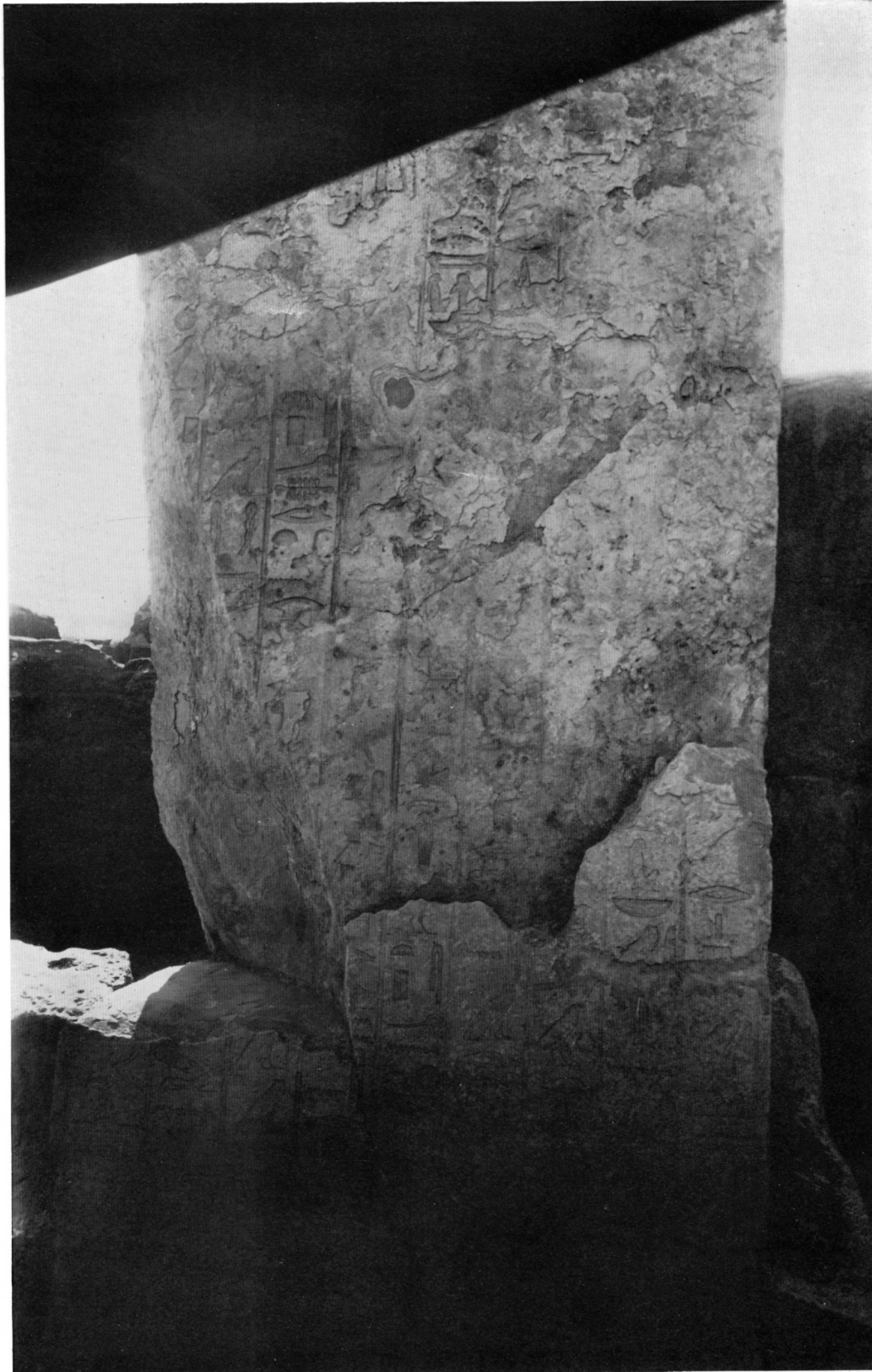

TOMB OF RE'-WER: INSCRIPTION ON PILLAR



TOMB OF RE'-WER: STATUE OF RE'-WER IN SHRINE



3



2



1

TOMB OF REO-WER: 1. FRAGMENT OF JAMB OF DOORWAY TO COURT
2 and 3. FRAGMENTS OF SEATED STATUES OF REO-WER



TOMB OF RE'-WER: VIEW OF STELA AND TWO SERDABS



TOMB OF RE'-WER: VIEW OF CENTRAL COURT



I

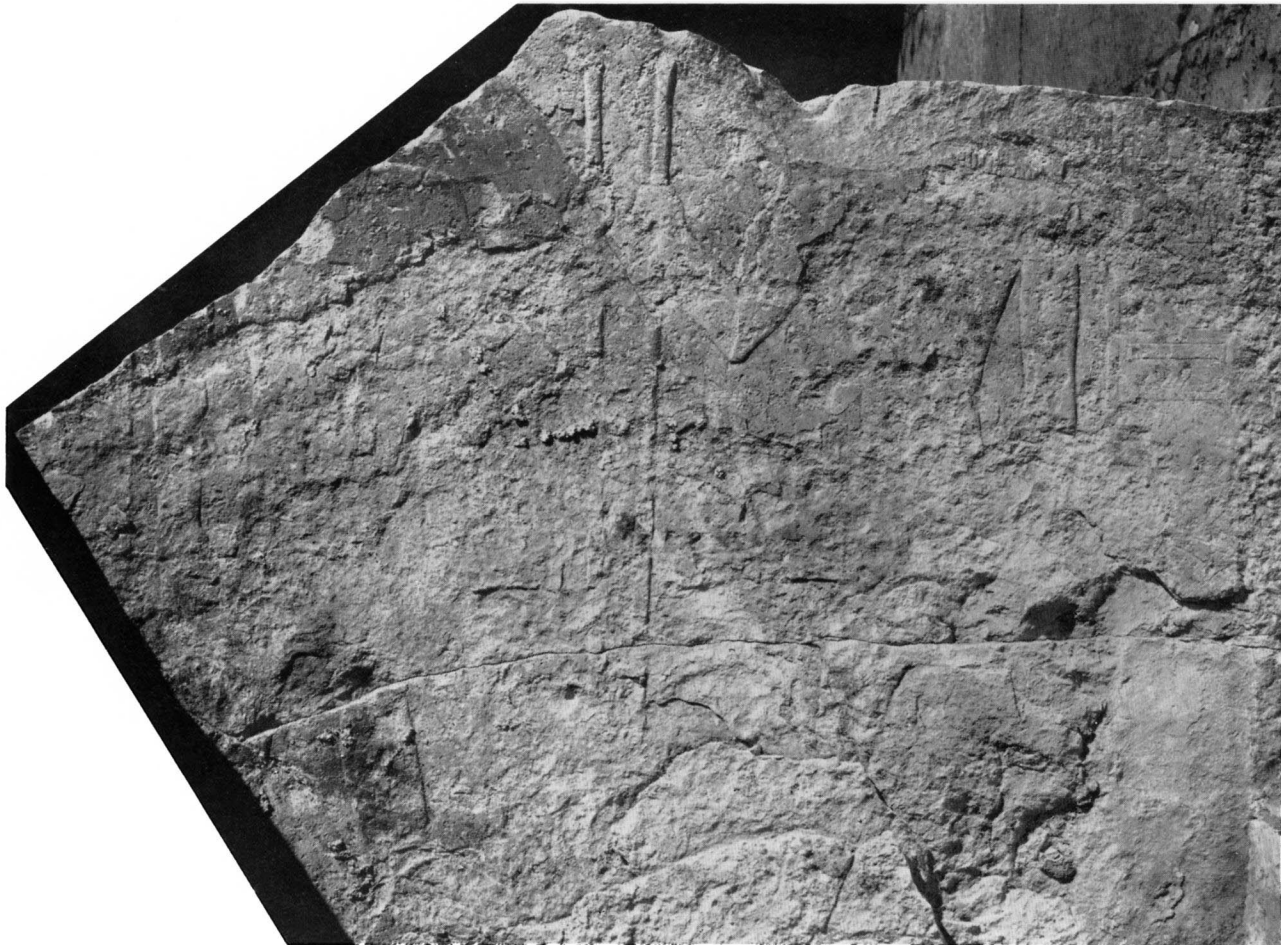

2

TOMB OF REU-WER: 1. FRAGMENT OF ROOFING AND 2 SCULPTURED SLAB IN COURT



TOMB OF REḲ-WER: BIOGRAPHICAL INSCRIPTION



TOMB OF RE-WER: STATUE IN NAOS



TOMB OF REU-WER: VIEW OF SERDAB NO. 13

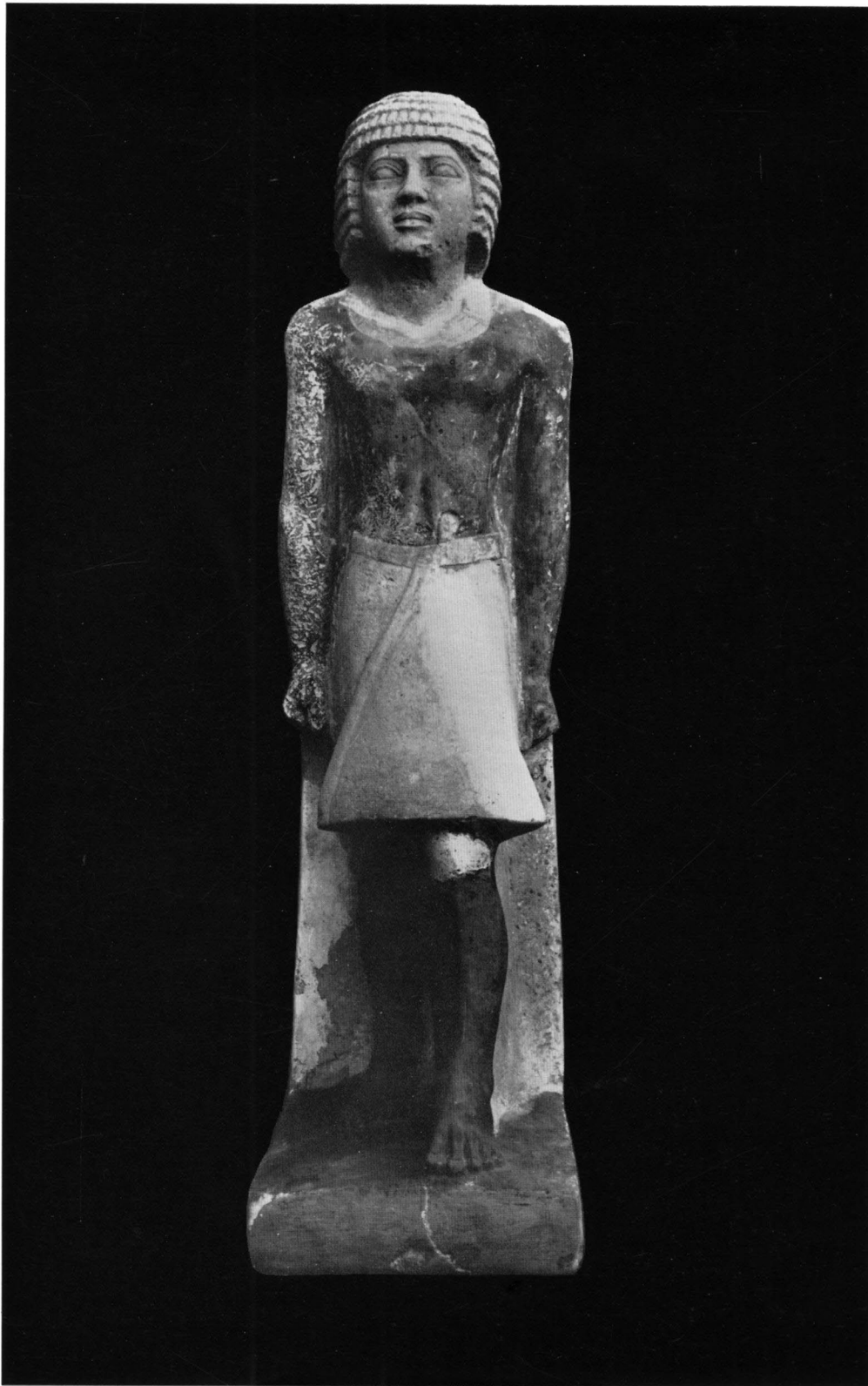

TOMB OF RE'-WER: LIMESTONE STATUETTE



TOMB OF RE-WER : TRIPLE STATUETTE IN LIMESTONE



I



2

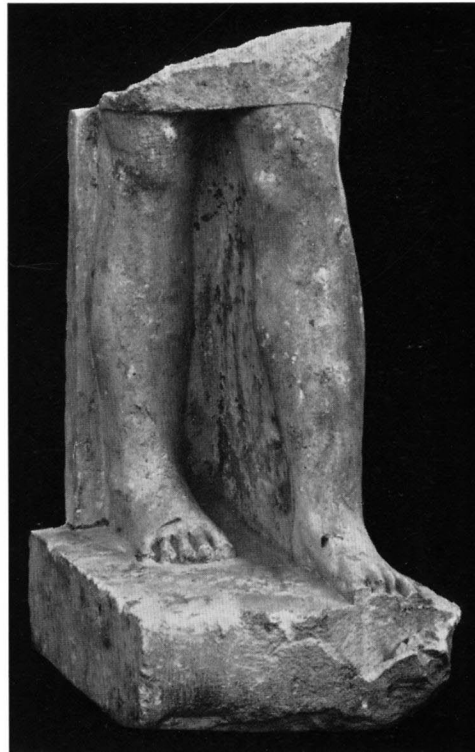

3

TOMB OF RE'-WER: FRAGMENTS OF STATUES



TOMB OF RE'-WER: PROFILE OF THE HEAD OF A LIMESTONE STATUE

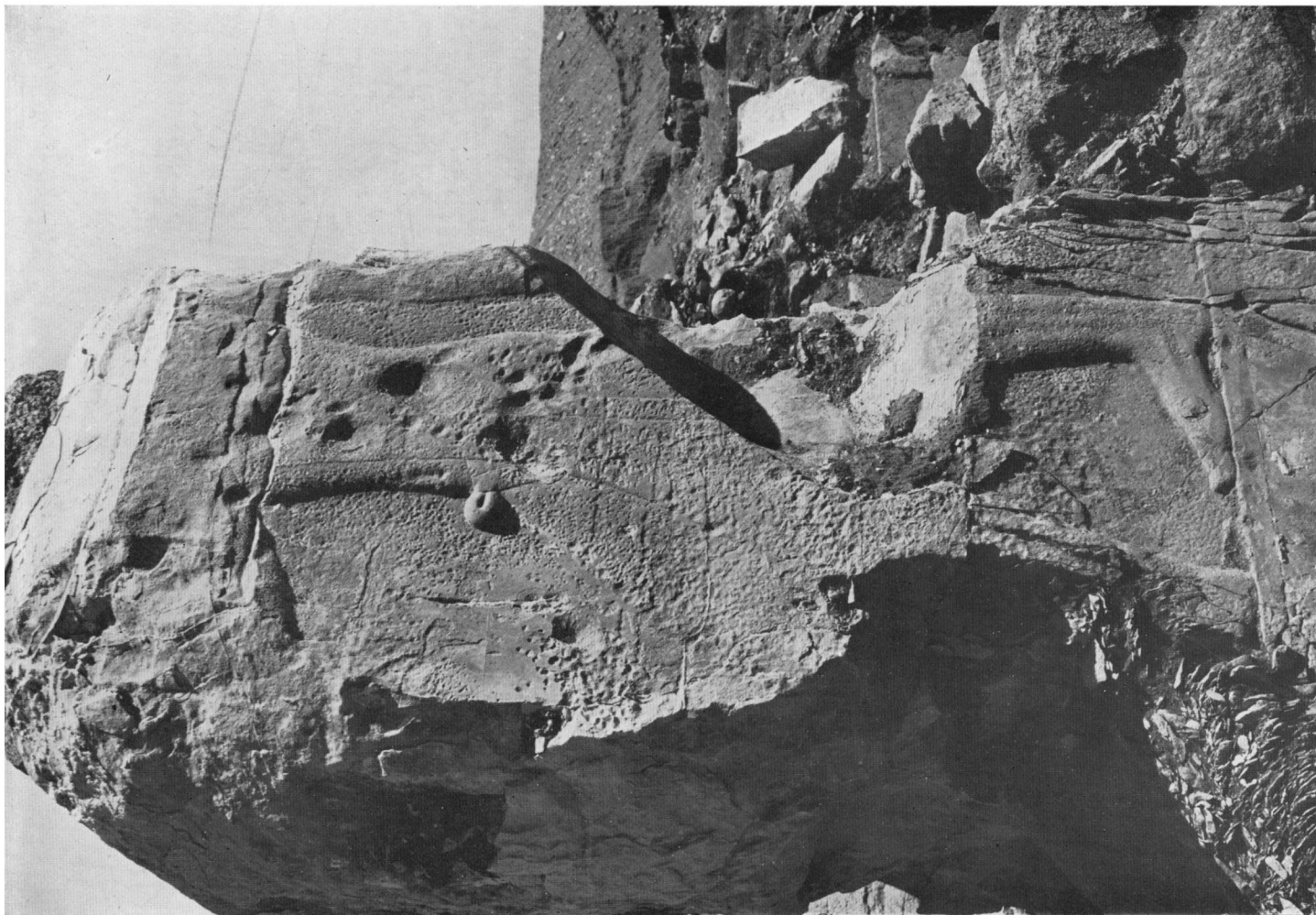

1



2

TOMB OF REU-WER: 1. VIEW OF PILLAR AND 2 VIEW OF THE FIRST ALABASTER ALTAR
IN THE CENTRAL COURT



TOMB OF RE'-WER: VIEW OF BRICK CHAMBER AND NICHE WITH ALABASTER PANEL



TOMB OF REO-WER: NICHE WITH ALABASTER PANEL *in situ*

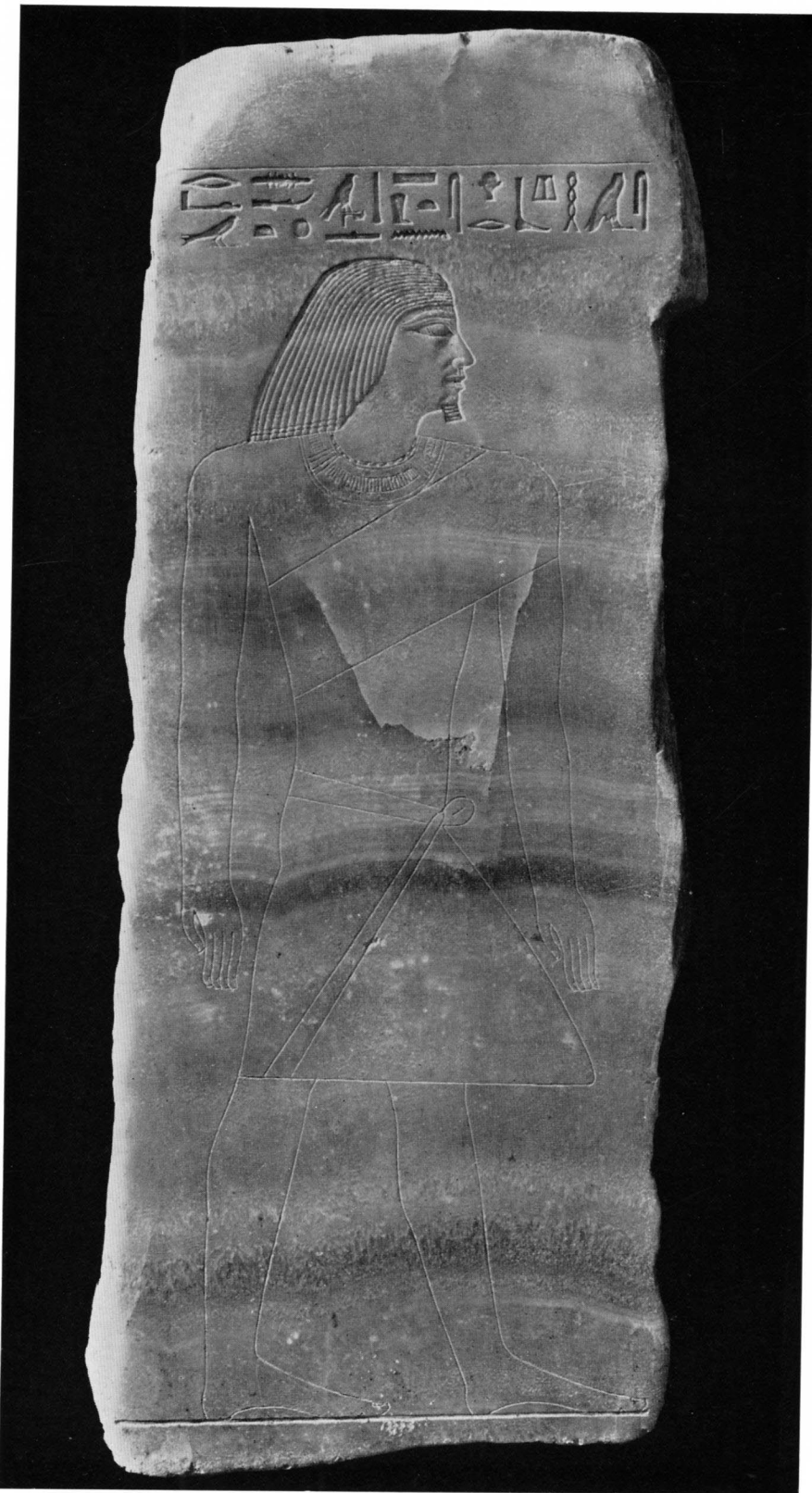

TOMB OF RE-WER: ALABASTER PANEL



TOMB OF RE'-WER: FRAGMENT OF A SCULPTURED SCENE



I



2



3

TOMB OF REO-WER: BASES OF STATUES OF REO-WER AND OF MEMBERS OF HIS FAMILY



TOMB OF REO-WER: VIEW OF ROCK-CUT CHAMBER



TOMB OF REU-WER: THE SECOND ALABASTER ALTAR

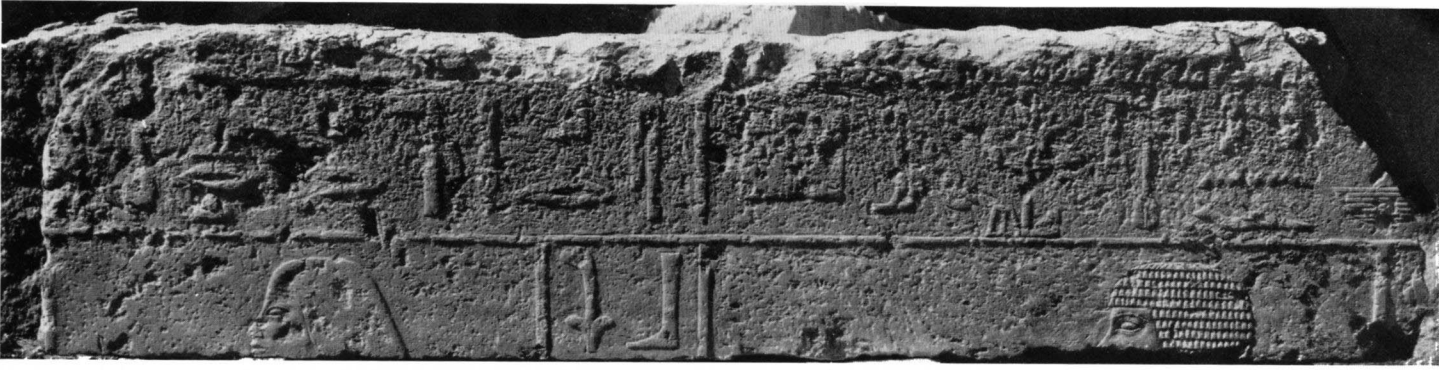

I

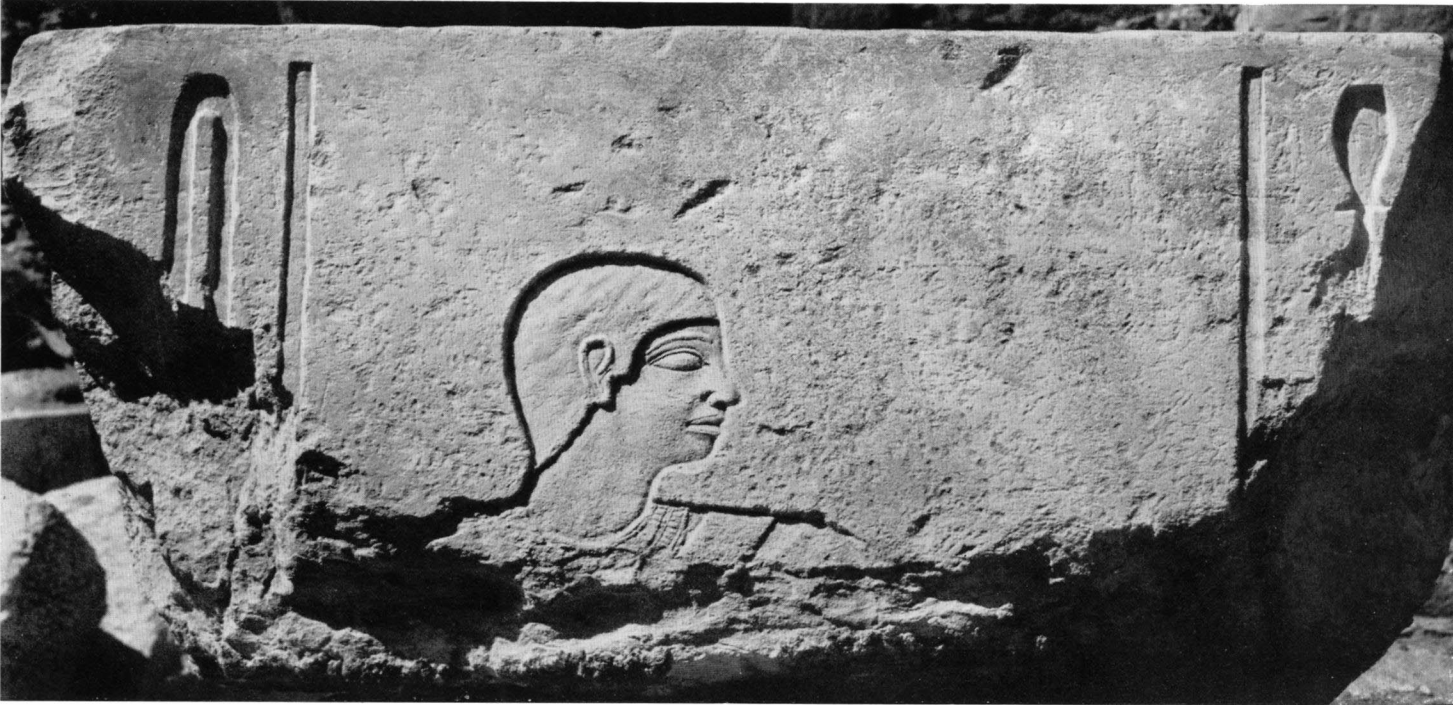

2



3

TOMB OF REU-WER: FRAGMENTS OF SCULPTURED SLABS

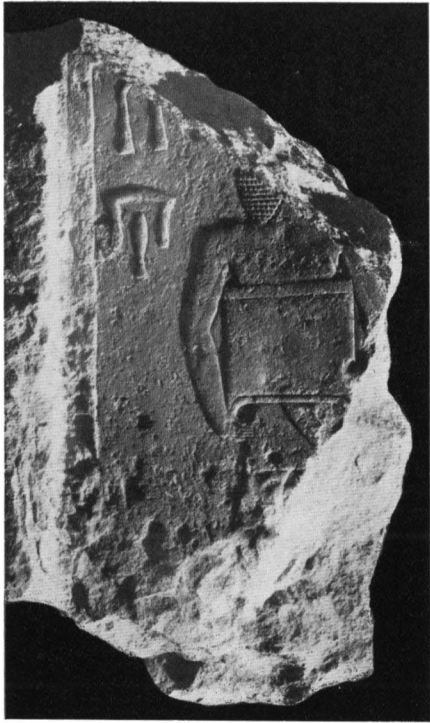

1

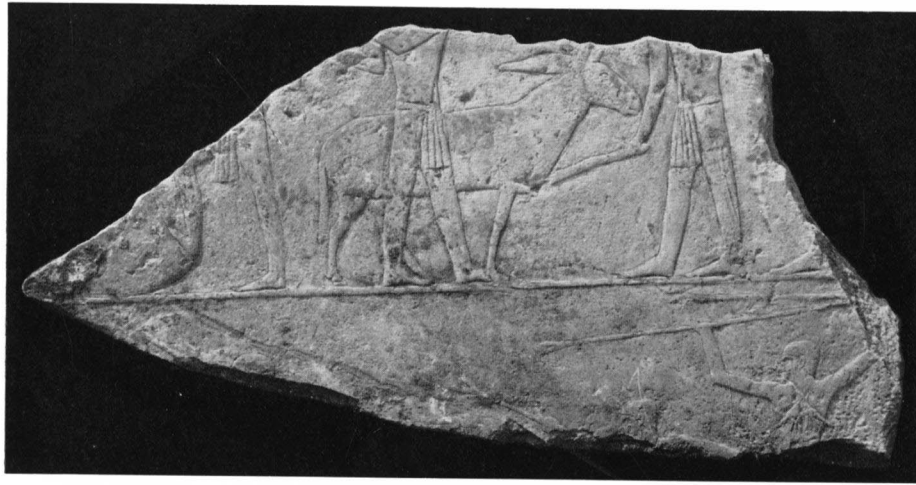

2

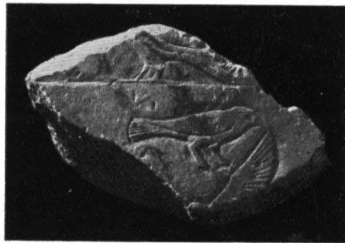

3



4

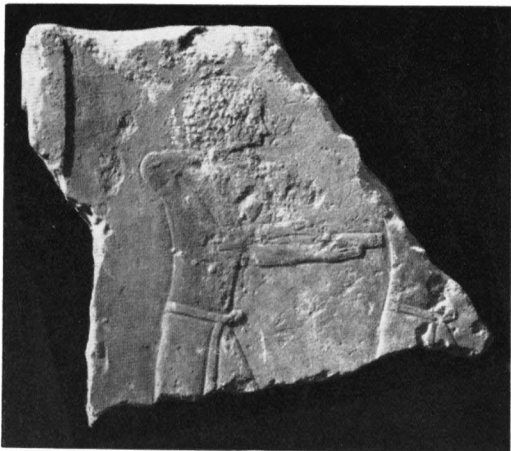

5



6

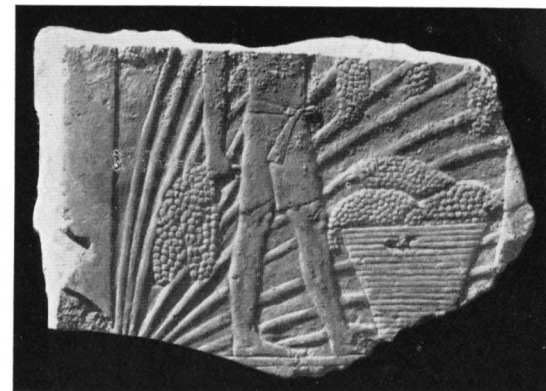

7

TOMB OF RE'-WER: FRAGMENTS OF SCULPTURED SLABS



3. TOMB OF REU-WER: INSCRIBED LIMESTONE SLAB

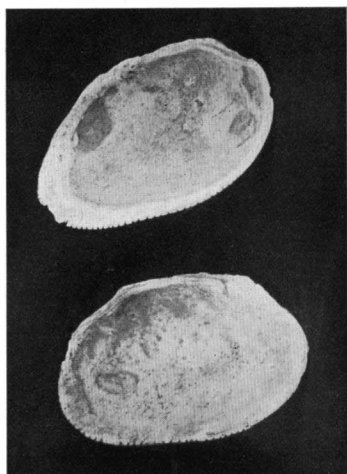

1

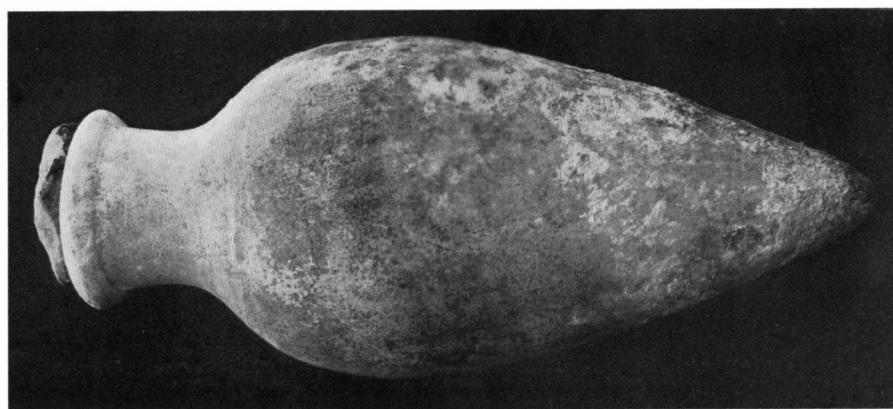

2

SHELLS AND POTTERY VASE
FROM SHAFT NO. 16

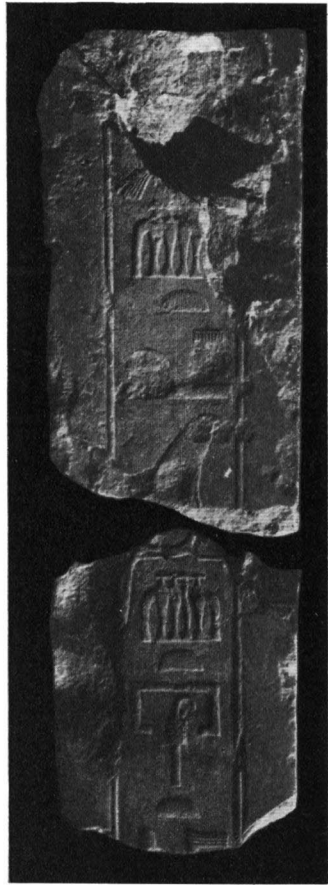

I



2



4



5

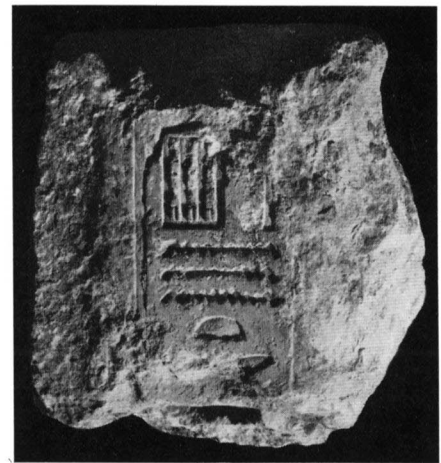

7

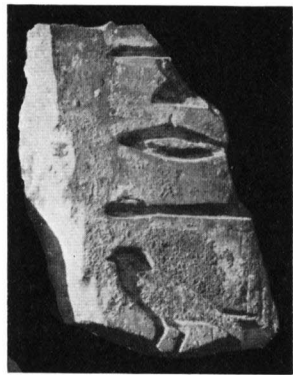

3



6

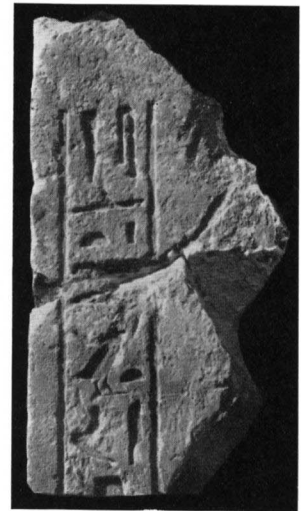

8

TOMB OF RE^c-WER: FRAGMENTS OF INSCRIBED BLOCKS

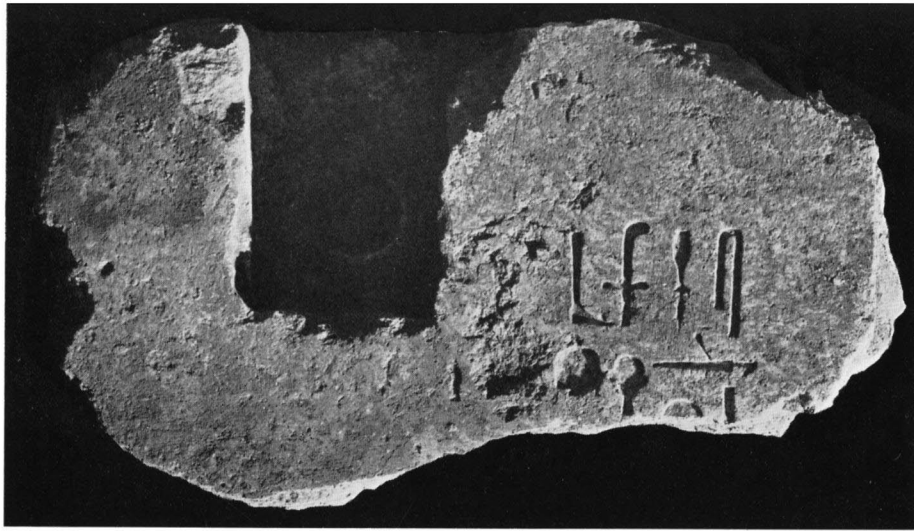

1

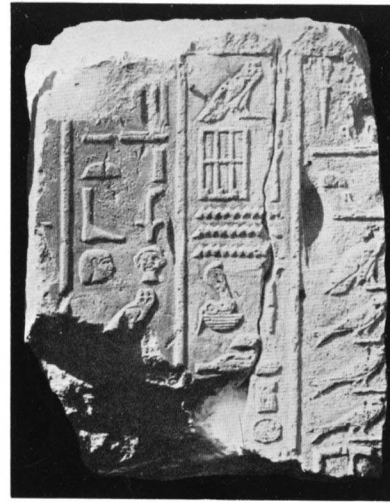

3

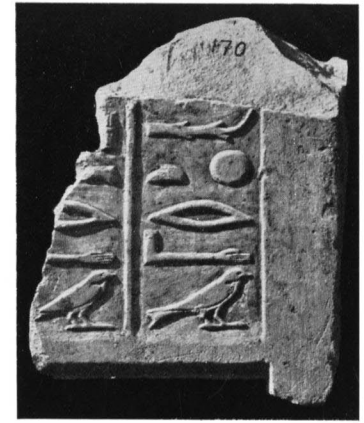

4

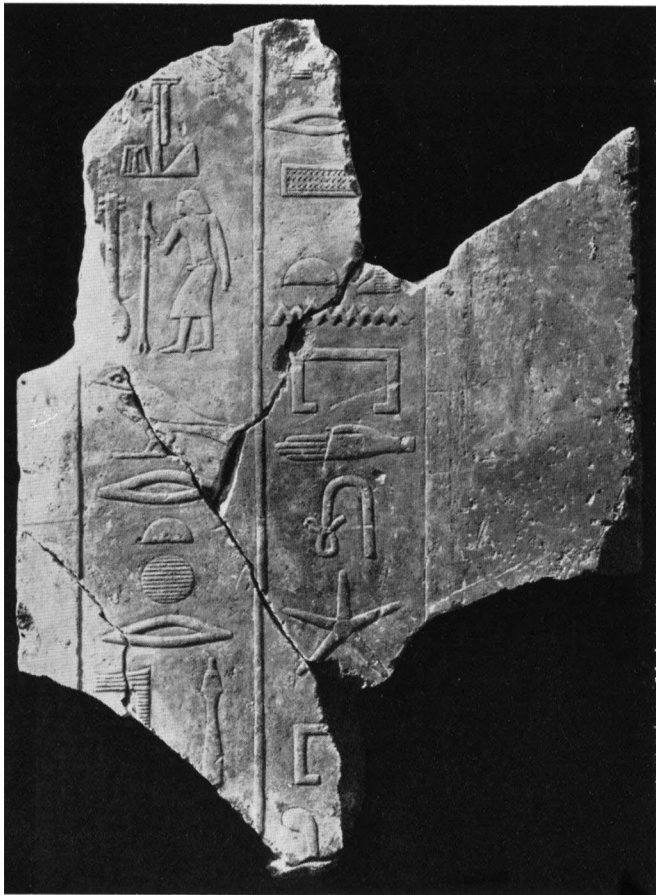

2

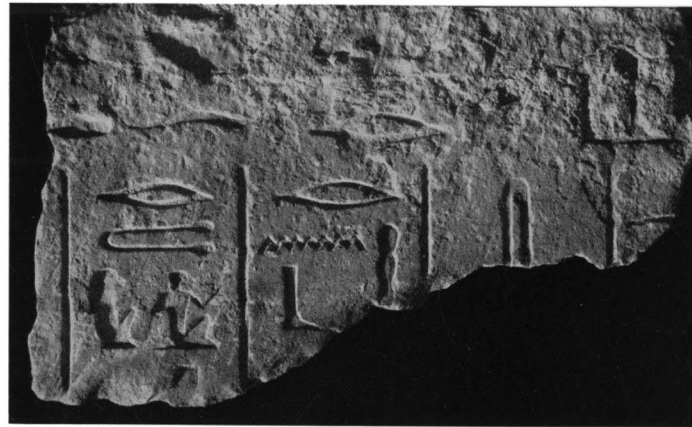

5

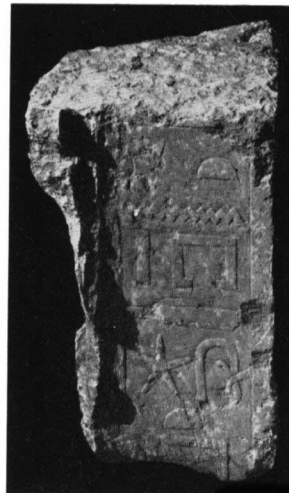

6



7

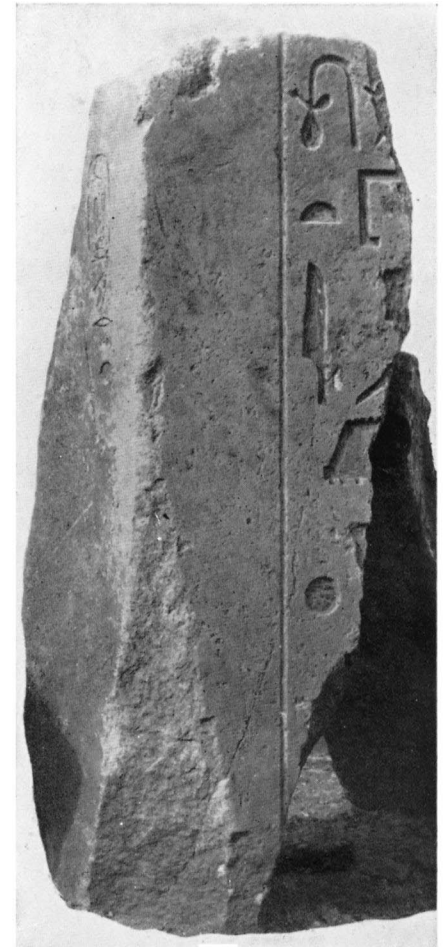

8

TOMB OF REU-WER: FRAGMENTS OF INSCRIBED BLOCKS



I



2

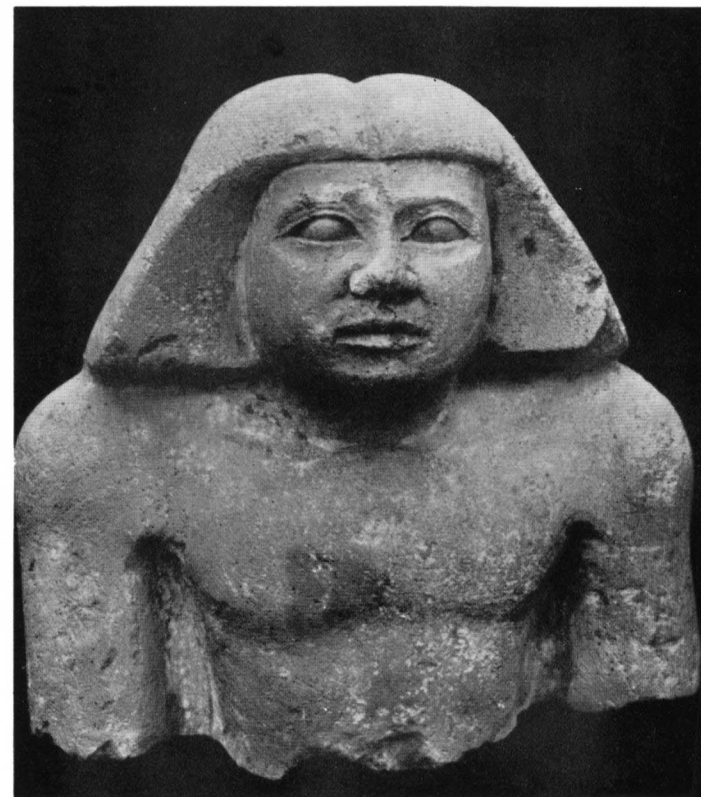

3

TOMB OF RE'-WER: HEADS OF STATUE AND STATUETTES

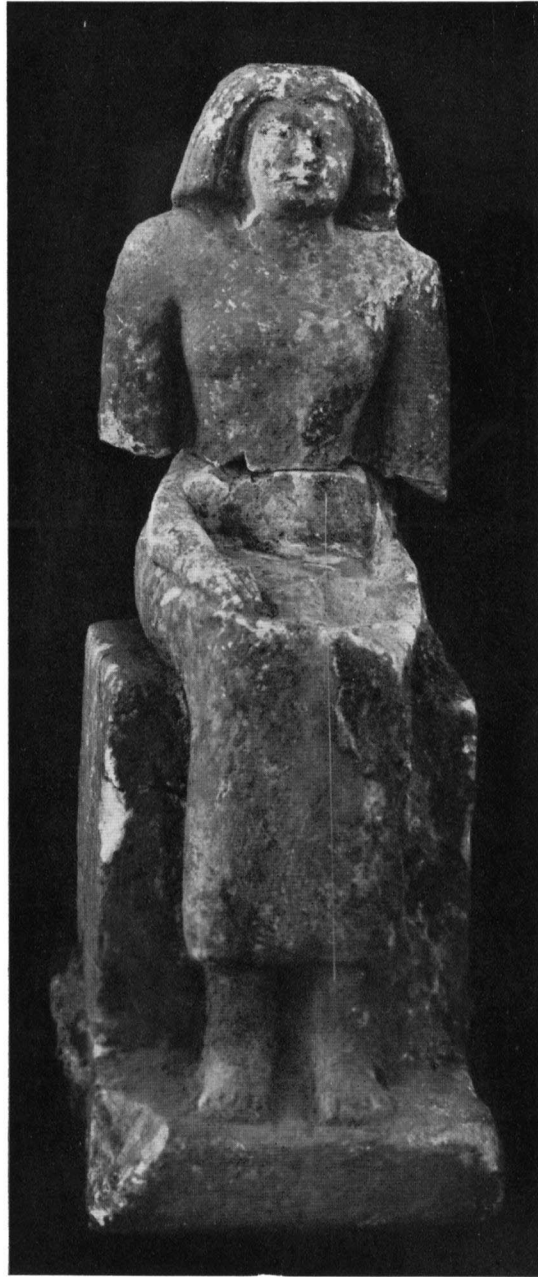

I

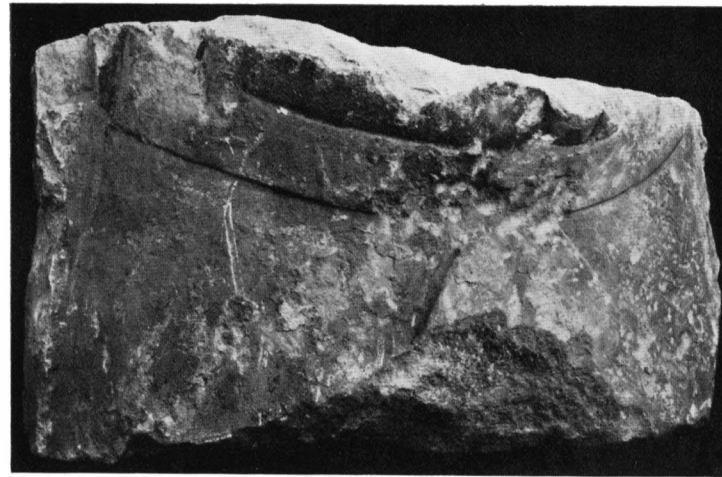

2

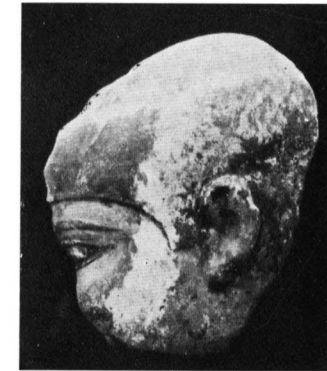

4



3

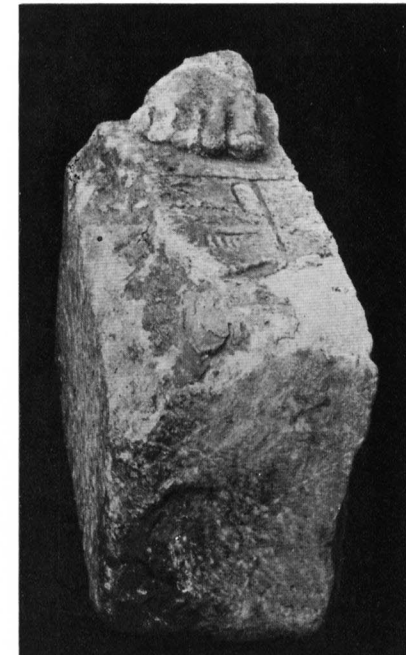

5

TOMB OF REU-WER: STATUETTE AND FRAGMENTS OF STATUES



TOMB OF RE-WER: FRAGMENTS OF LIMESTONE STATUES AND STATUETTES

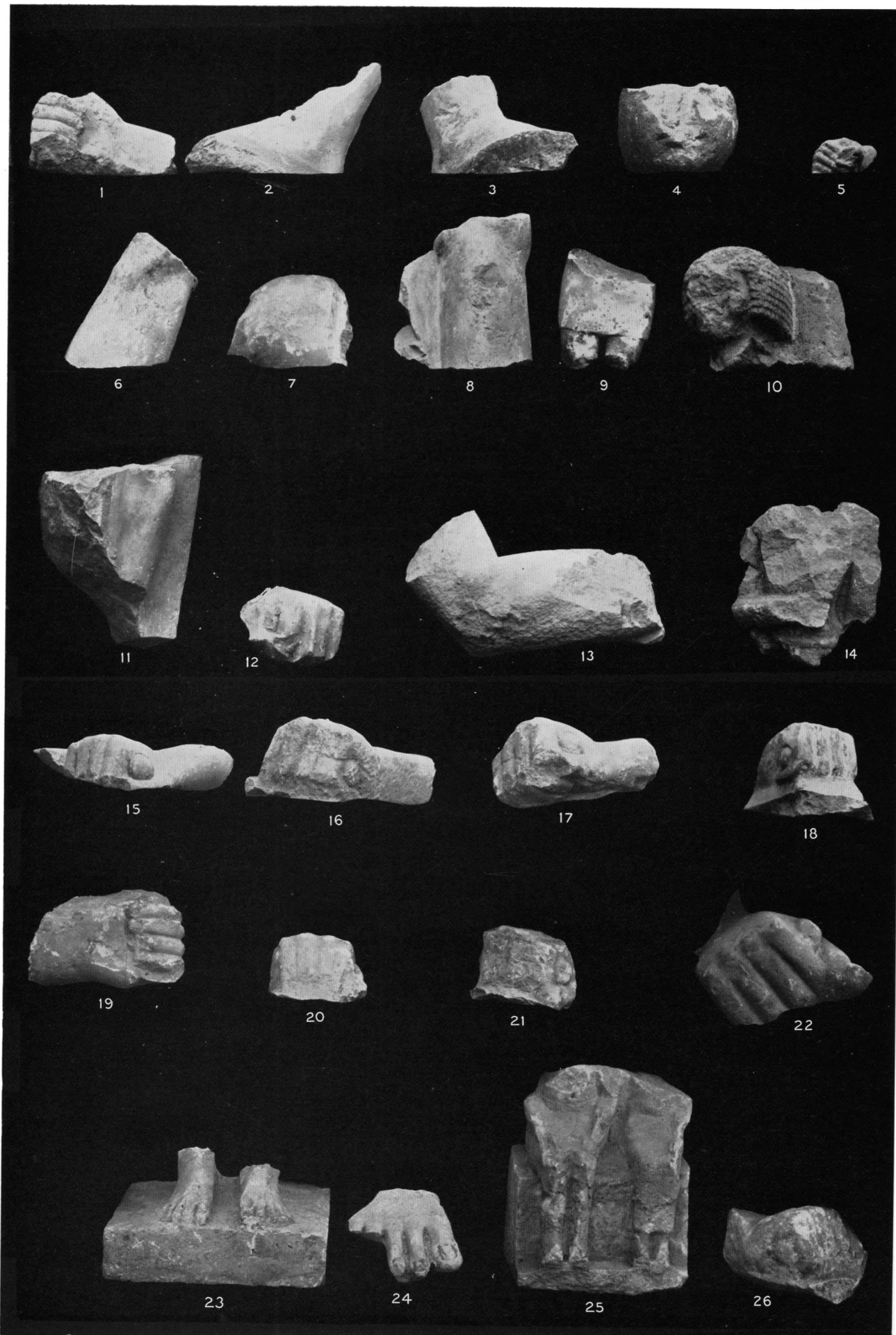

TOMB OF RE'-WER: FRAGMENTS OF LIMESTONE STATUETTES

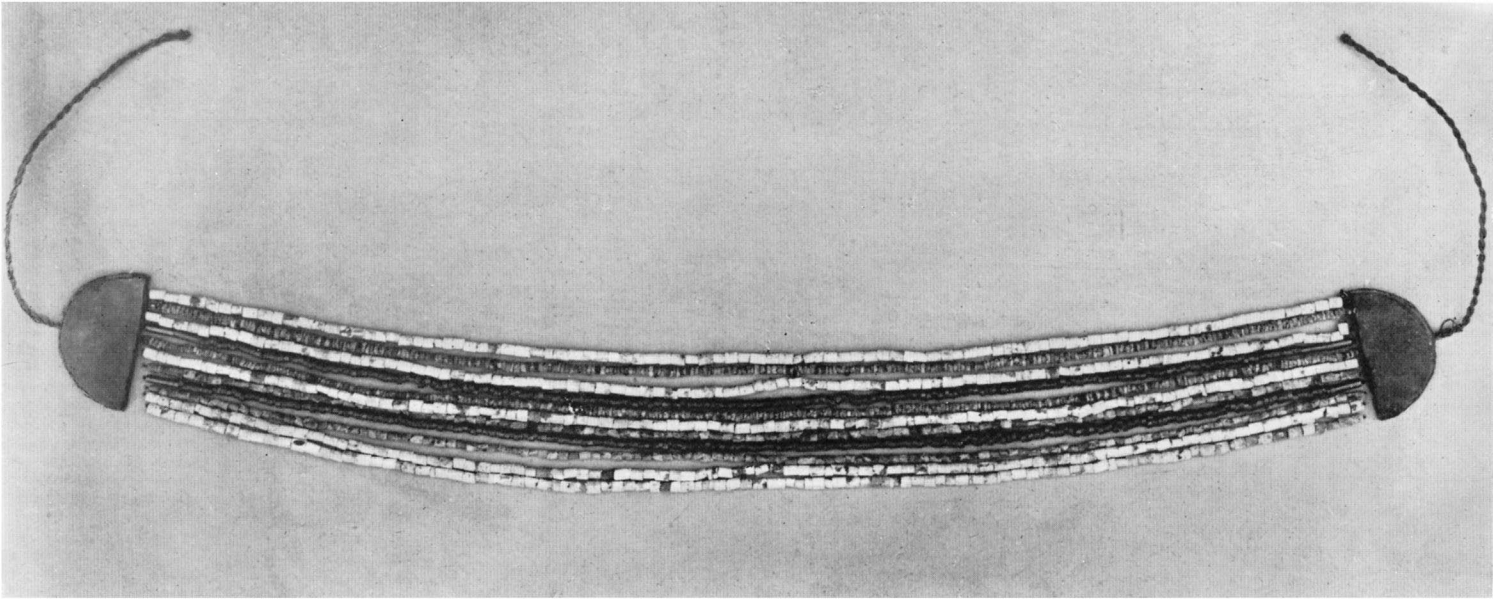

I



2



3



4

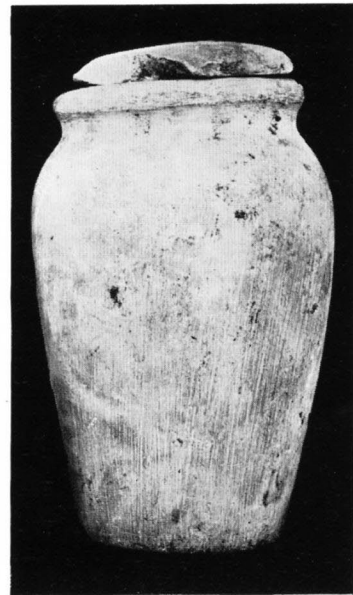
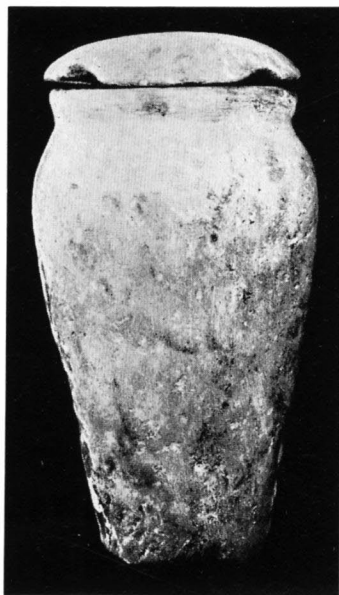
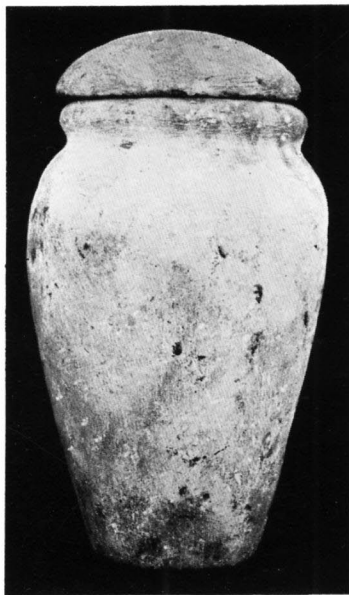

5

TOMB OF MERU-KA : (1) NECKLACE, (2 to 4) FRAGMENTS OF SCULPTURED BLOCKS, and (5) CANOPIC JARS

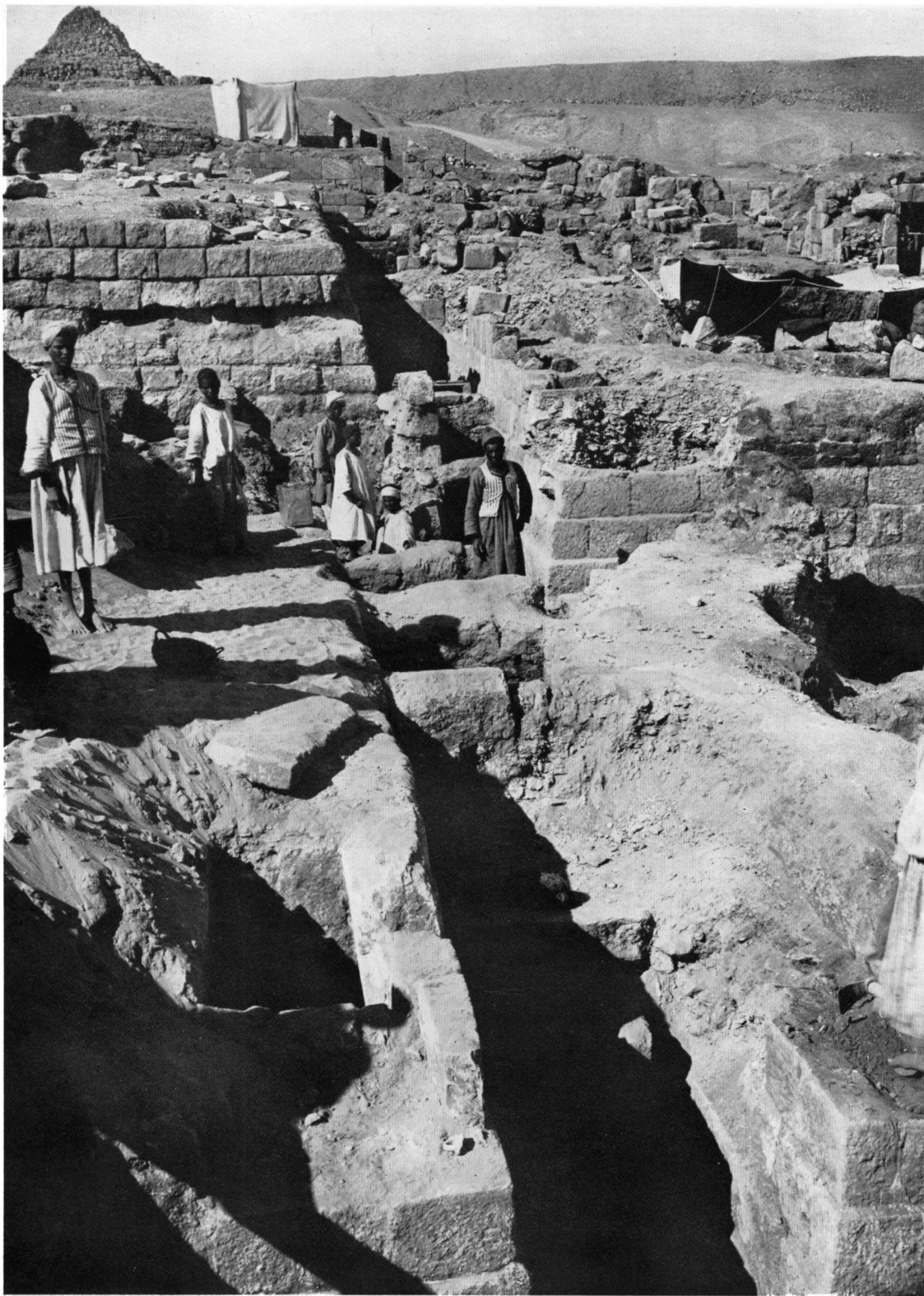

VIEW OF MASTABA OF ZEFA-NESUT



1. FALSE-DOOR OF RE'-WER



2. STATUETTE OF ZEFA-NESUT

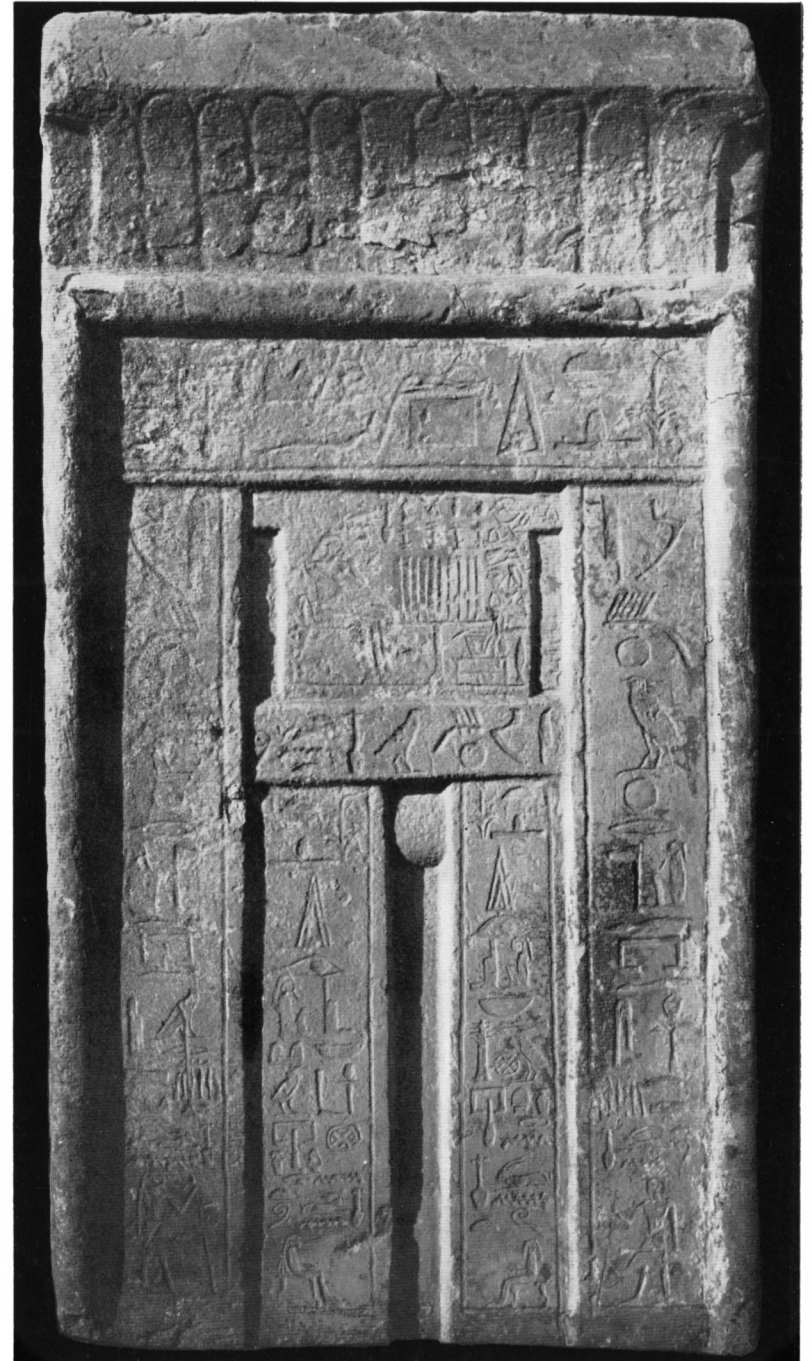

3. FALSE-DOOR OF NEFER-WENT



1. TOMB OF NEFER-WENT : FAIENGE BEADS

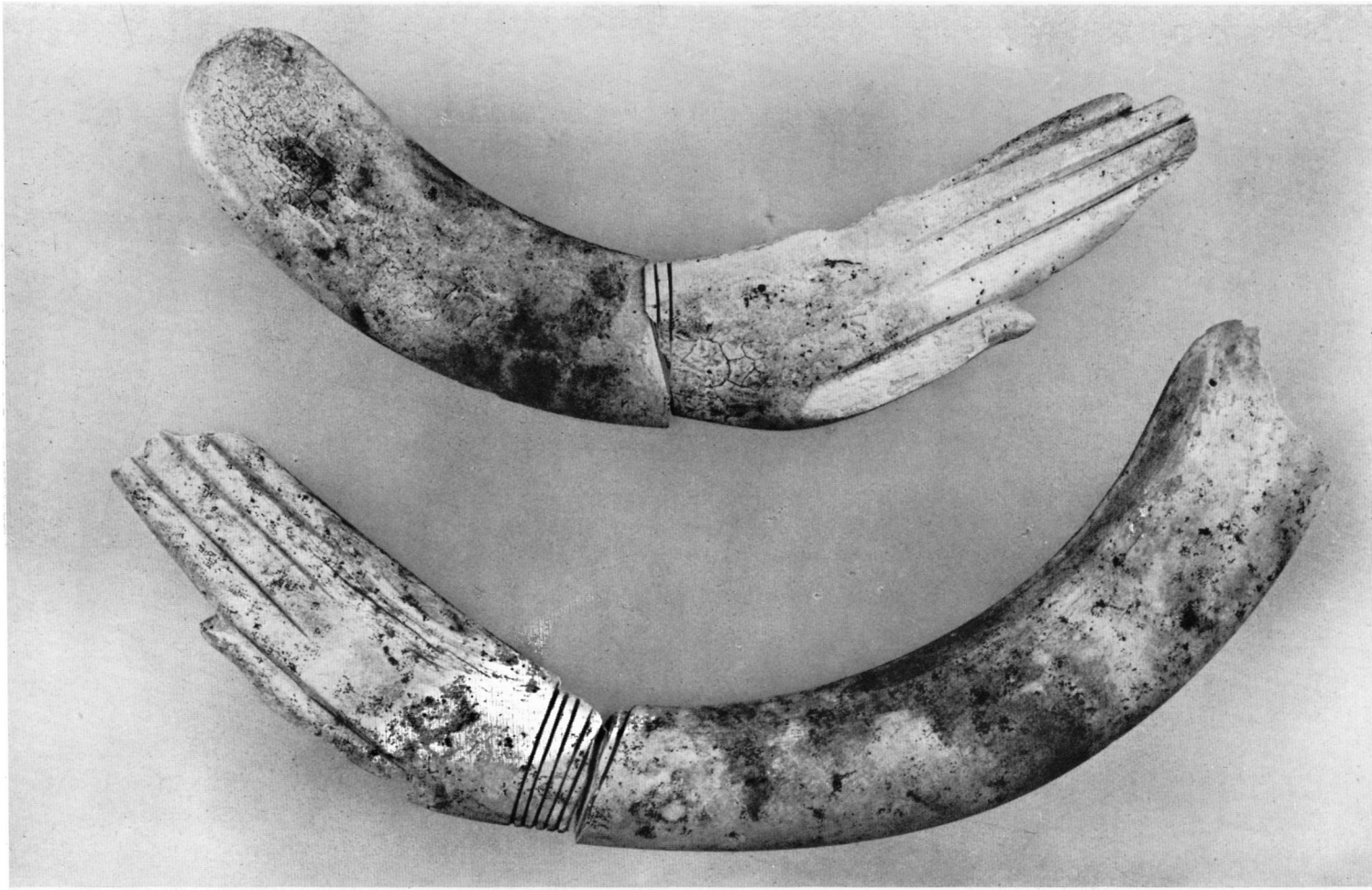

2. IVORY CASTANETS FOUND IN THE COURTYARD OF THE ROCK-CUT TOMB

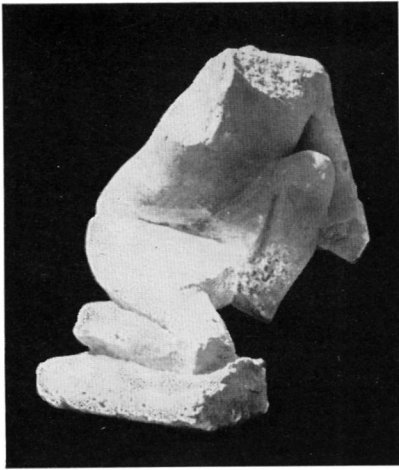

I

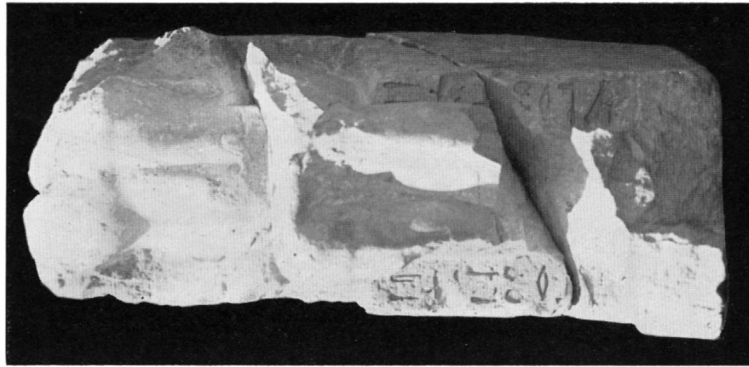

2

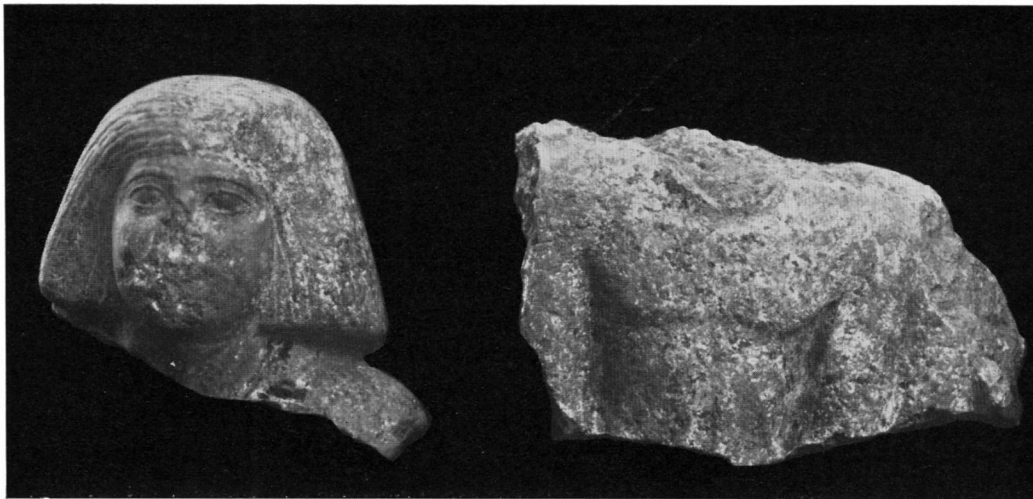

3

4



5

FRAGMENTS OF SCULPTURE FROM THE MASTABA OF SHAFT NO. 35

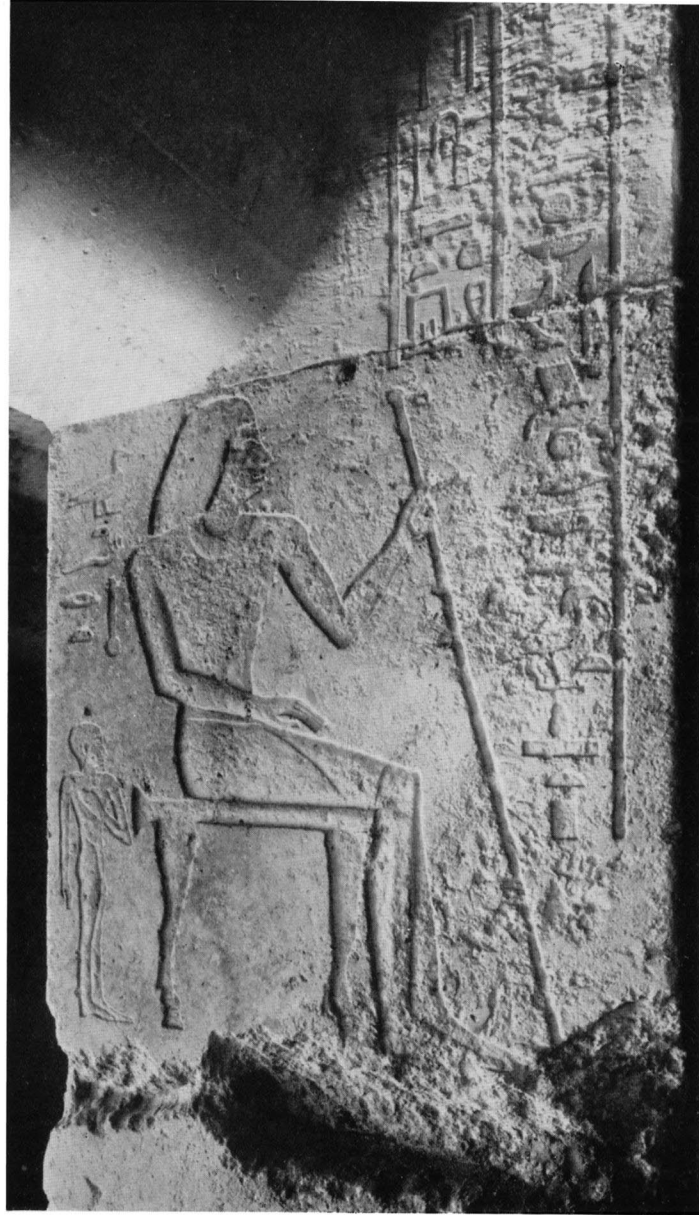

TOMB OF AKHET-HETEP : SCULPTURES ON JAMBS OF ENTRANCE DOORWAY

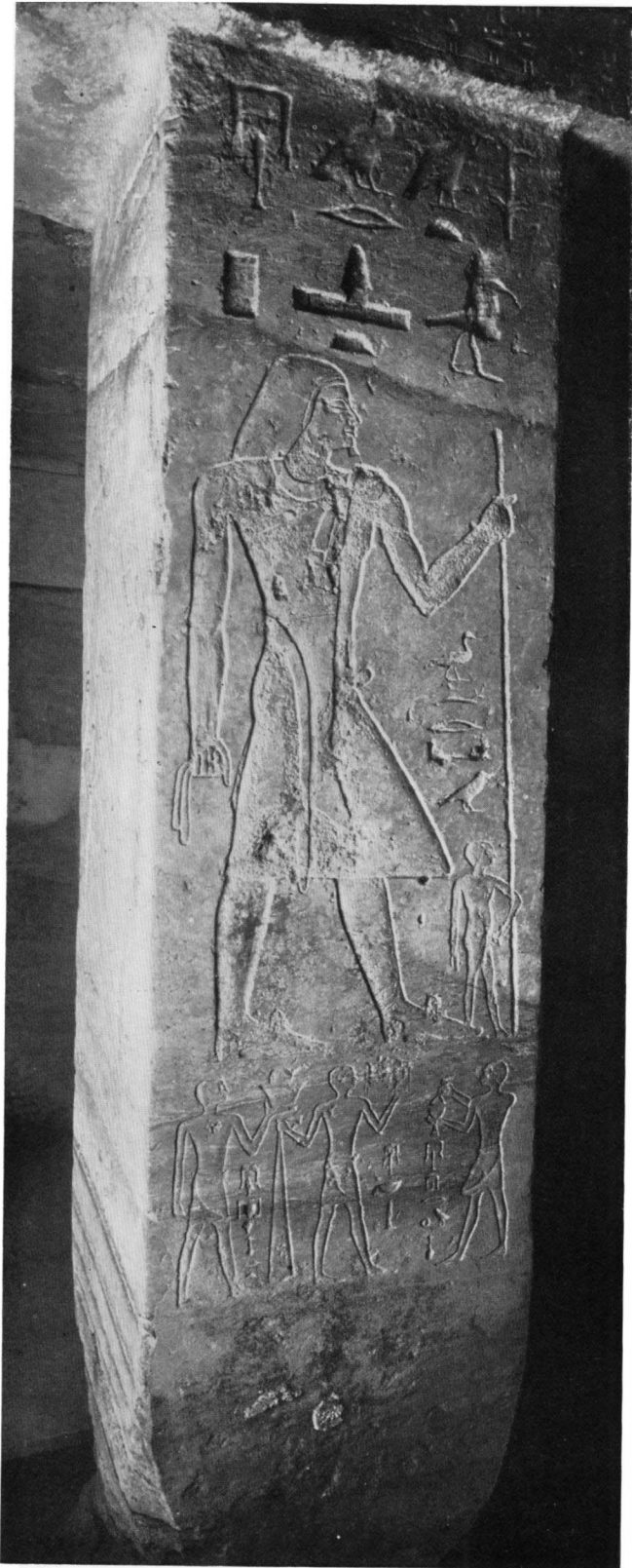

I



2

TOMB OF AKHET-HETEP : SCULPTURED FACES OF PILLAR IN CHAMBER

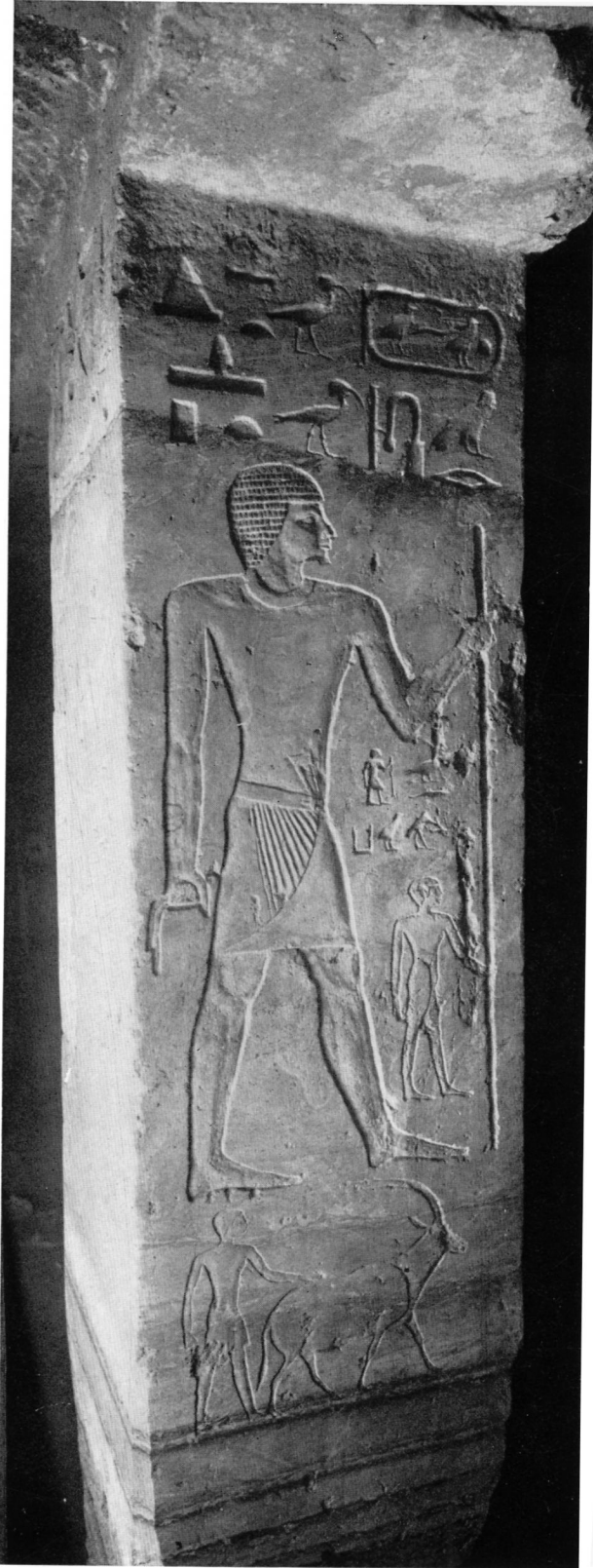

1

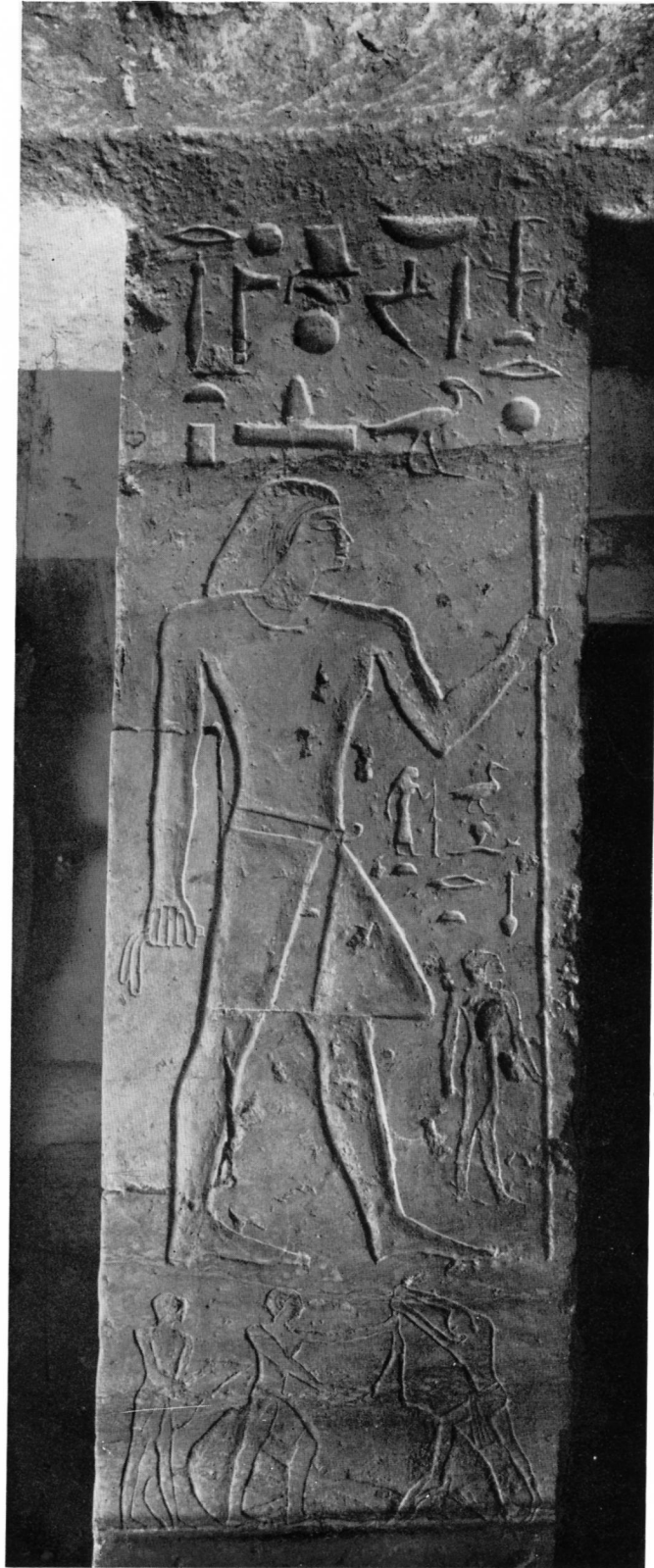

2

TOMB OF AKHET-HETEP : SCULPTURED FACES OF PILLARS IN CHAMBER

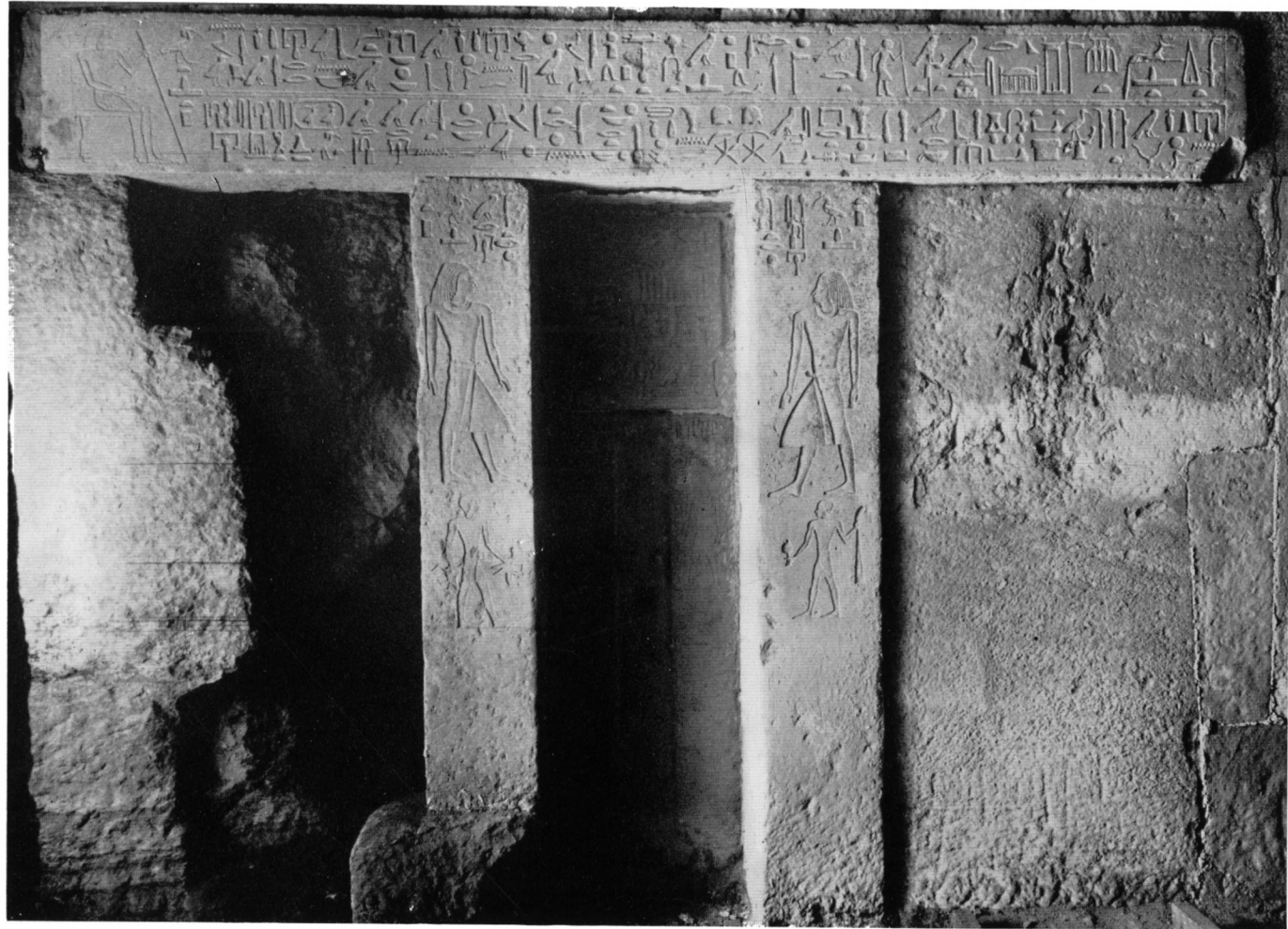

TOMB OF AKHET-HETEP : FALSE DOOR

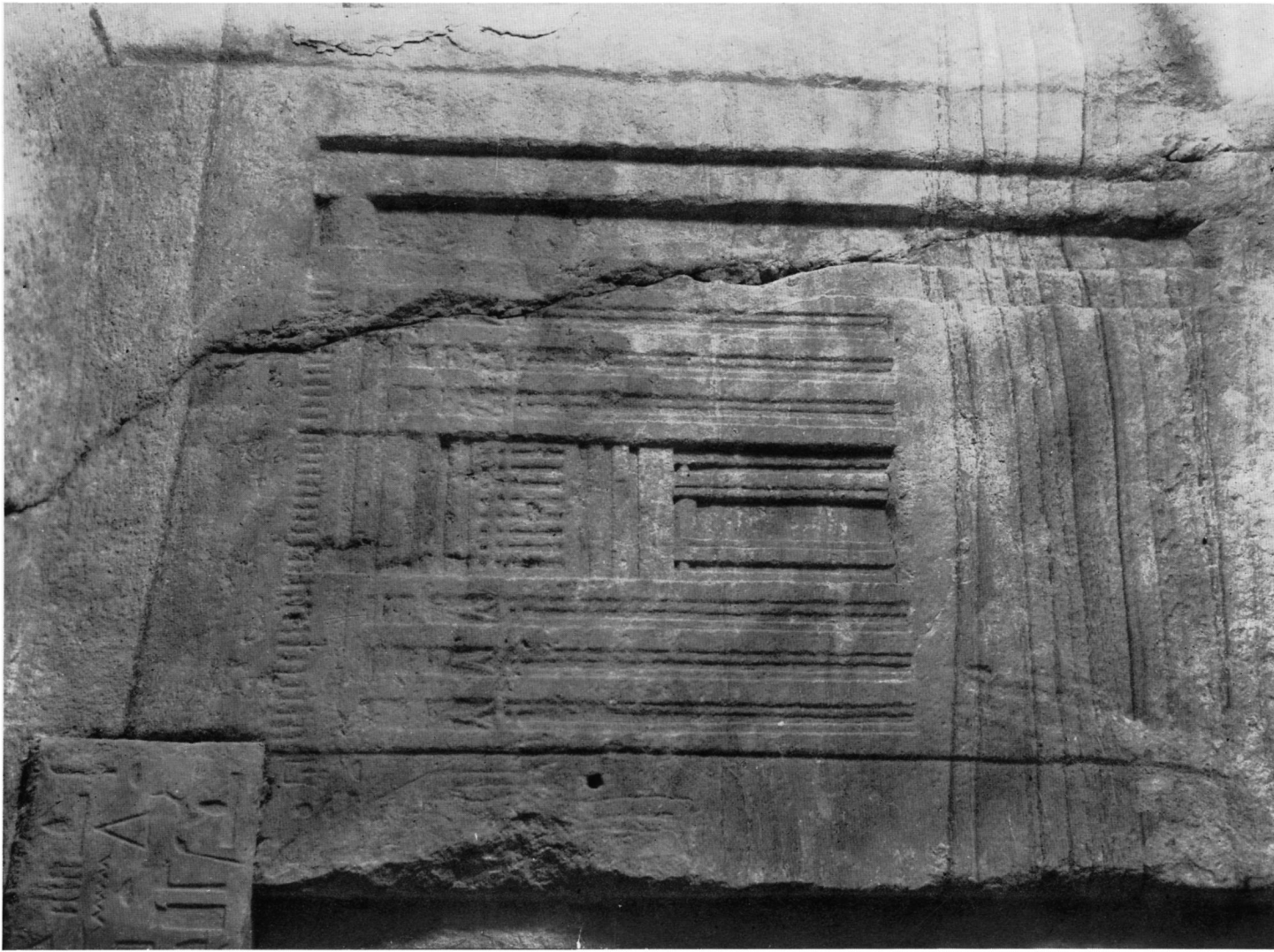

2

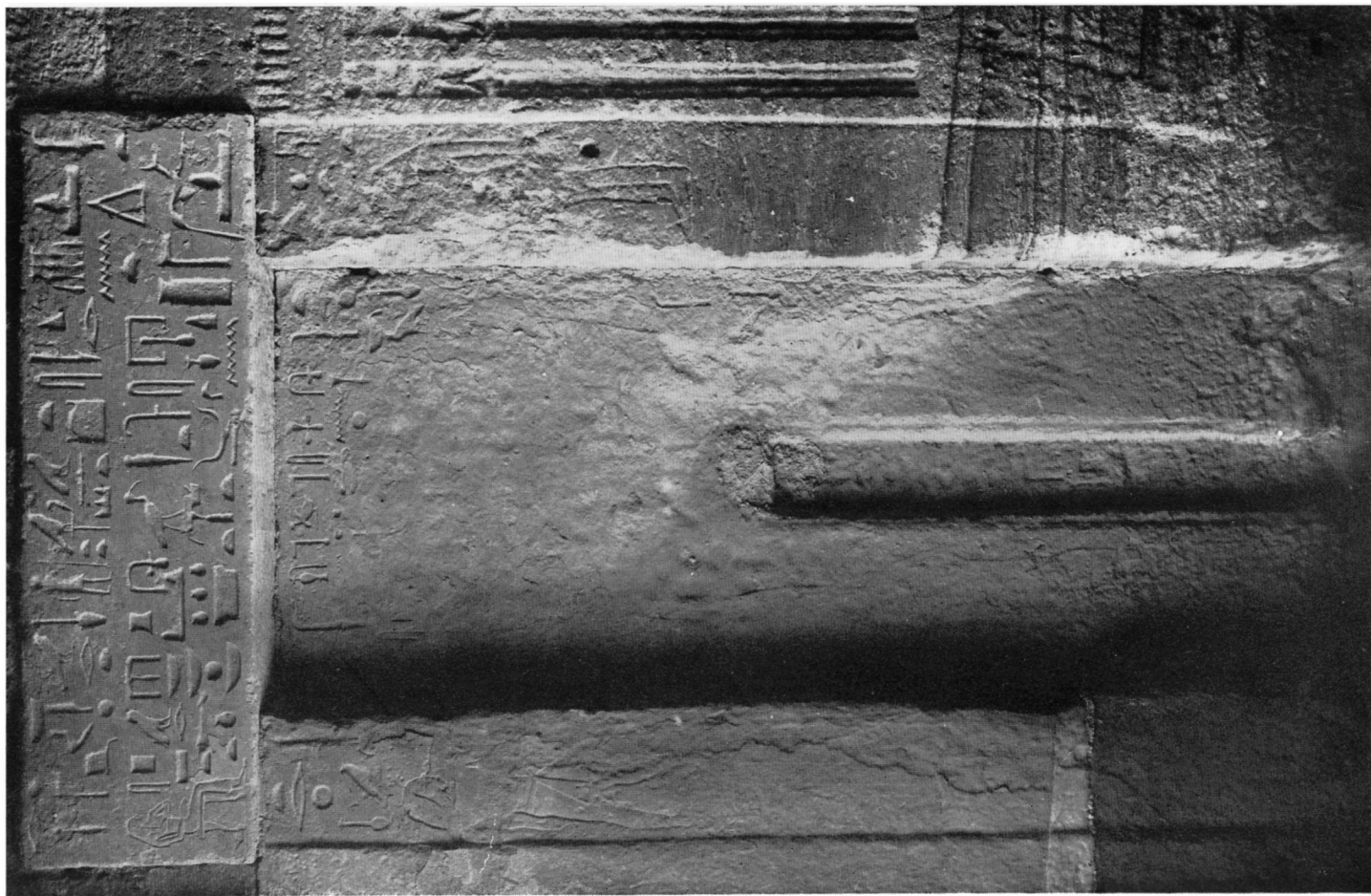

1

TOMB OF AKHET-HETEP : FALSE DOORS



TOMB OF DEDA : VIEW OF ENTRANCE



1. TOMB OF DEDA : SCULPTURED FIGURE IN CHAMBER BY DOORWAY



2. TOMB OF DEDA : FALSE DOOR AND SCULPTURED FIGURES ON INNER WALL



1



2

TOMB OF DEDA : SCULPTURED FIGURES ON WALLS OF CHAMBER



VIEW OF THE FAÇADE OF THE ROCK-CUT TOMB



2



1



3

TOMB OF IMBY : (1) ENTRANCE. (2) LINTEL. (3) FALSE DOOR

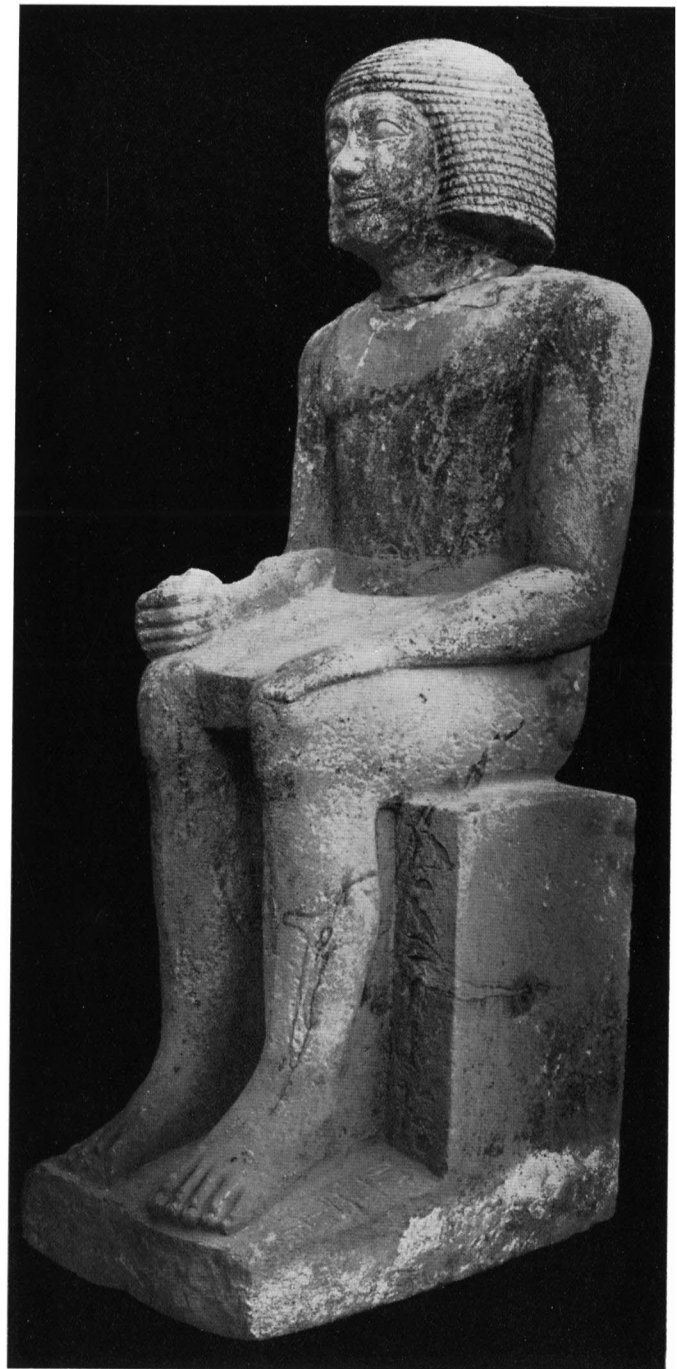
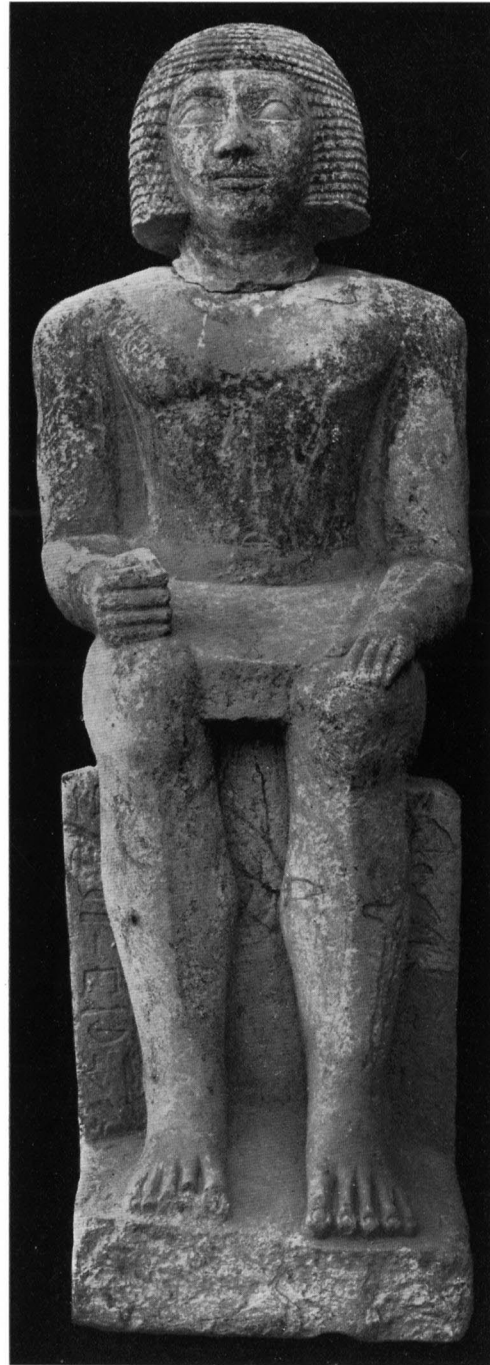
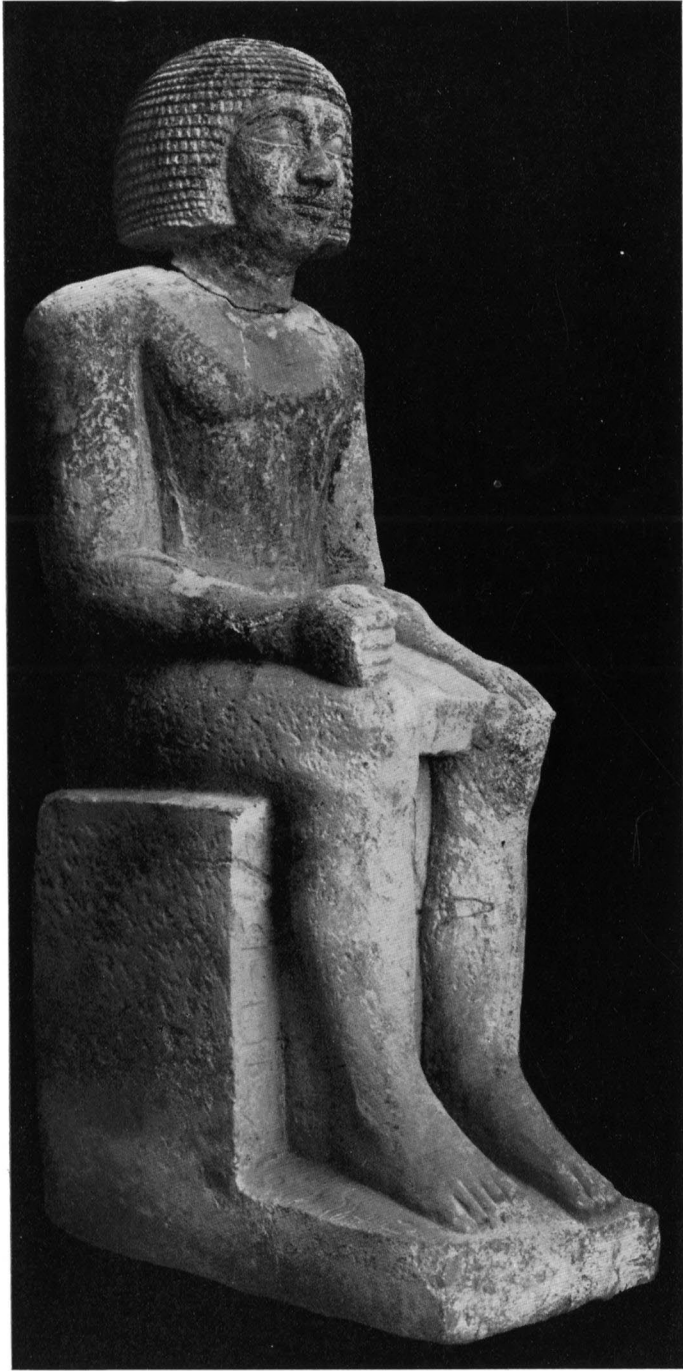

TOMB OF IMBY : LIMESTONE STATUETTE

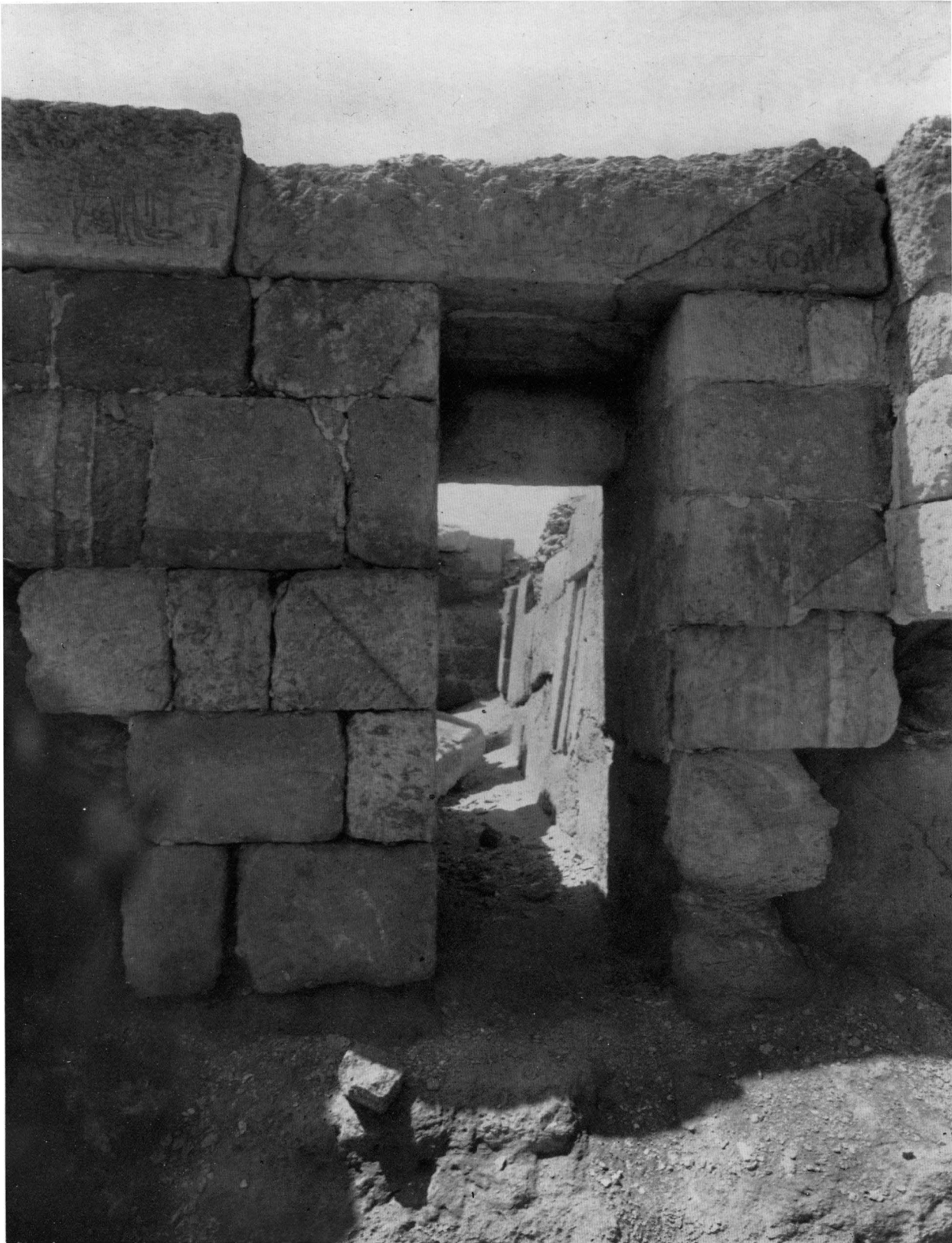

TOMB OF WESER : VIEW OF ENTRANCE



1



2

TOMB OF FIFI : (1) VIEW OF ENTRANCE. (2) FRAGMENTS OF A STATUETTE FOUND
IN THE SHAFT AND SARCOFAGUS CHAMBER



TOMB OF FIFI : THE FALSE DOOR



TOMB OF FIFI: THE SARCOPHAGUS CHAMBER WITH SARCOPHAGUS

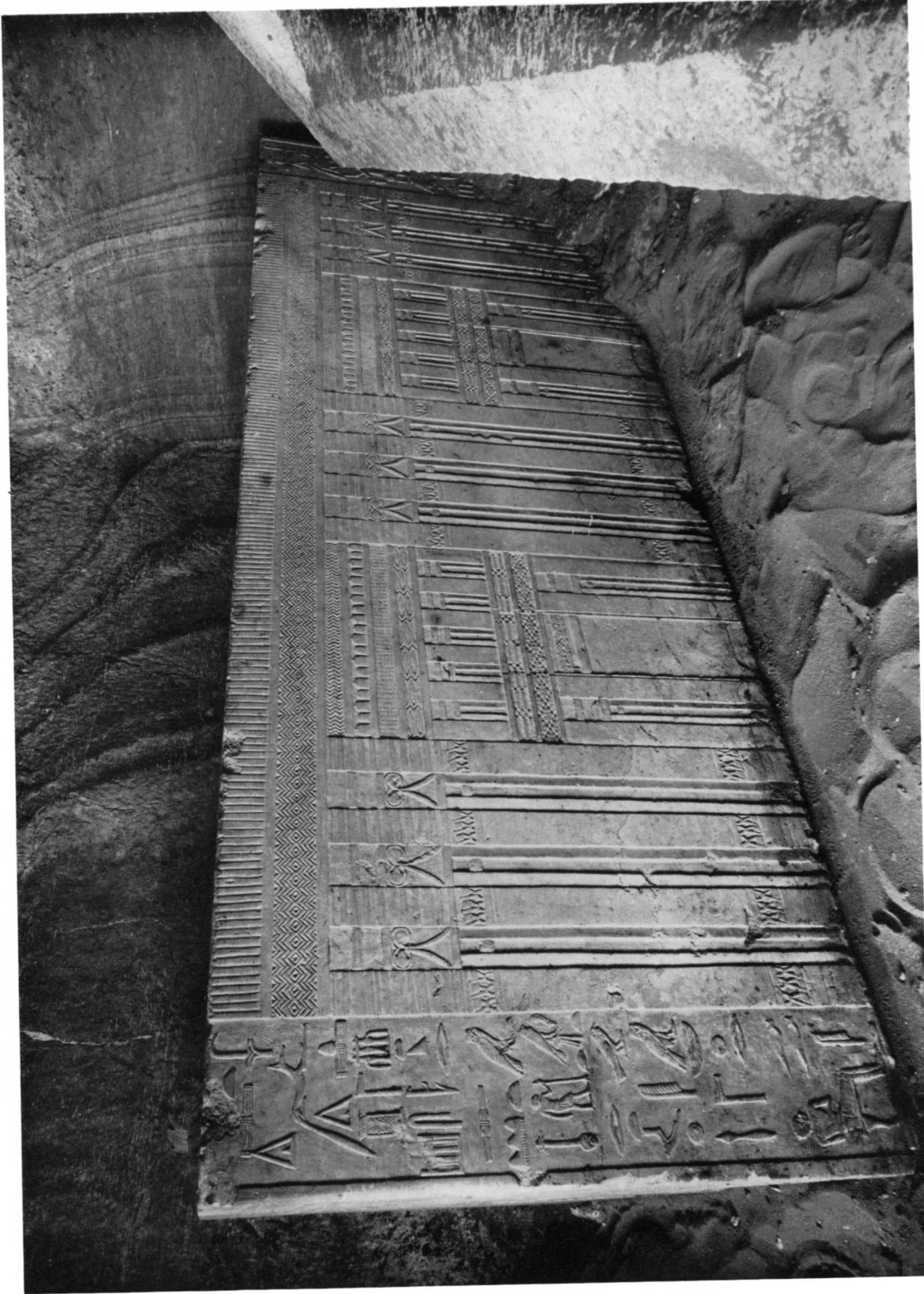

TOMB OF FIFI: VIEW OF SIDE OF THE SARCOPHAGUS IN THE SARCOPHAGUS CHAMBER

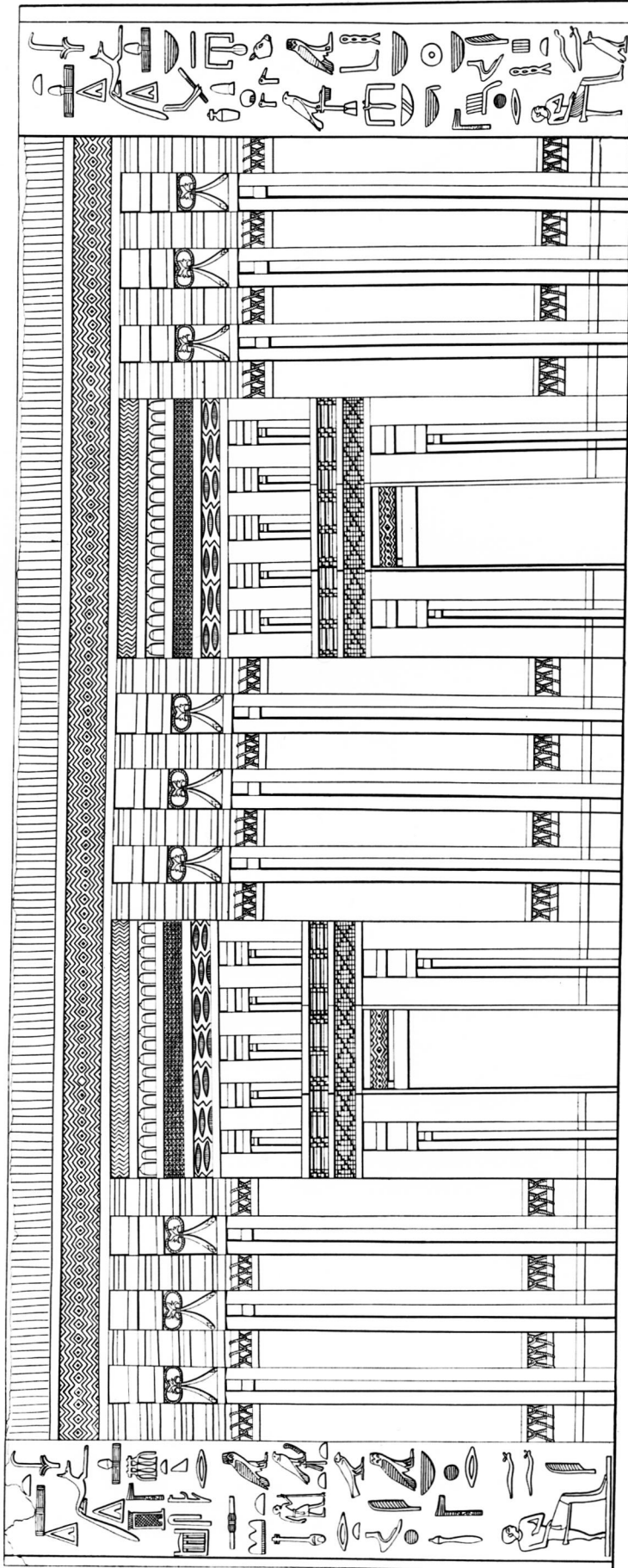

TOMB OF FIFI: WEST SIDE OF THE SARCOPHAGUS

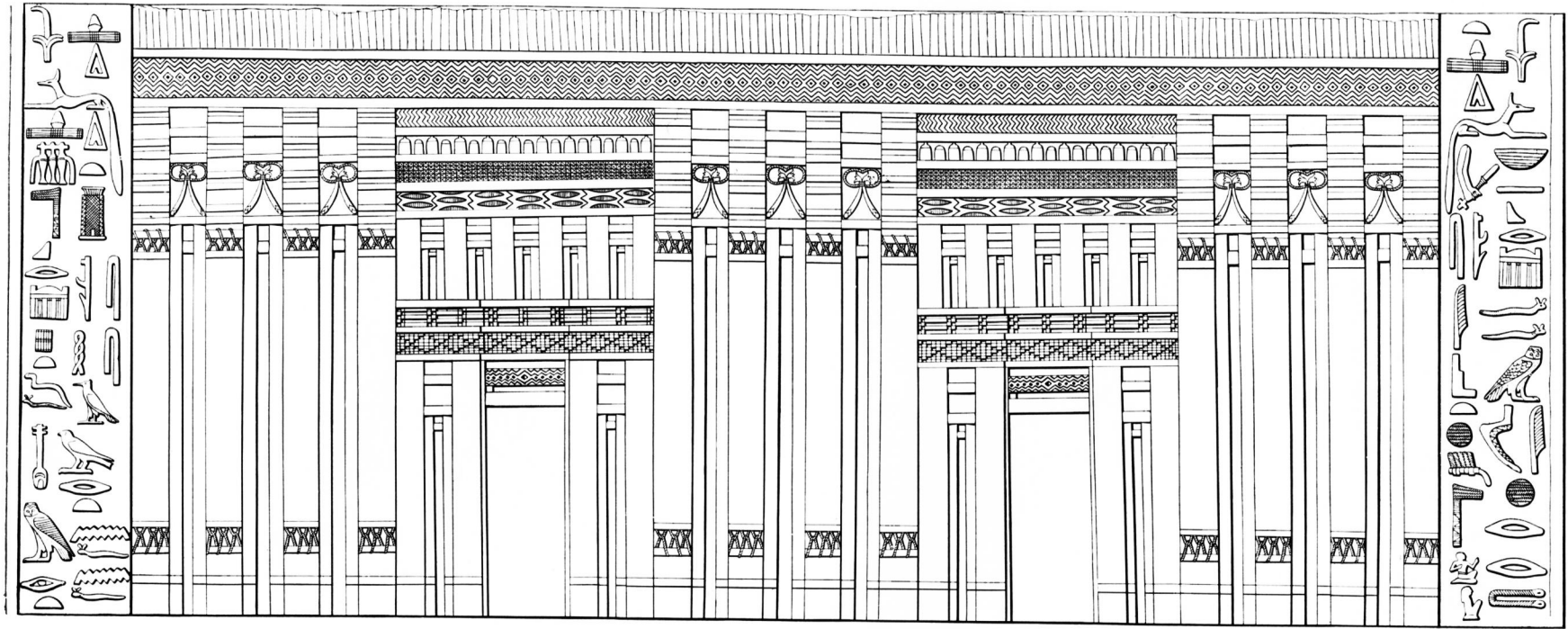

TOMB OF FIFI: EAST SIDE OF THE SARCOPHAGUS

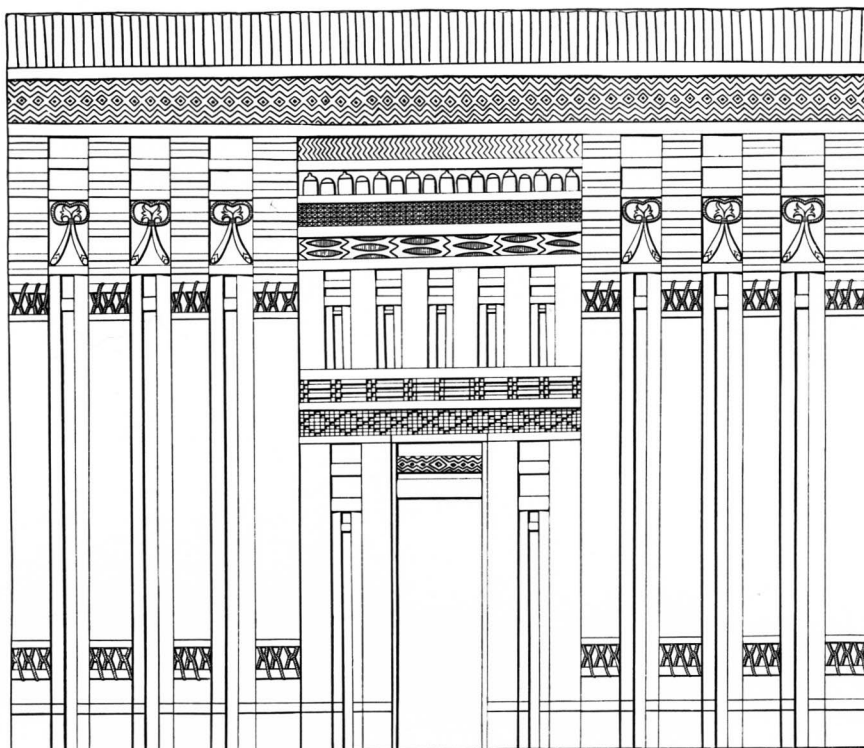

TOMB OF FIFI: NORTH END OF THE SARCOPHAGUS

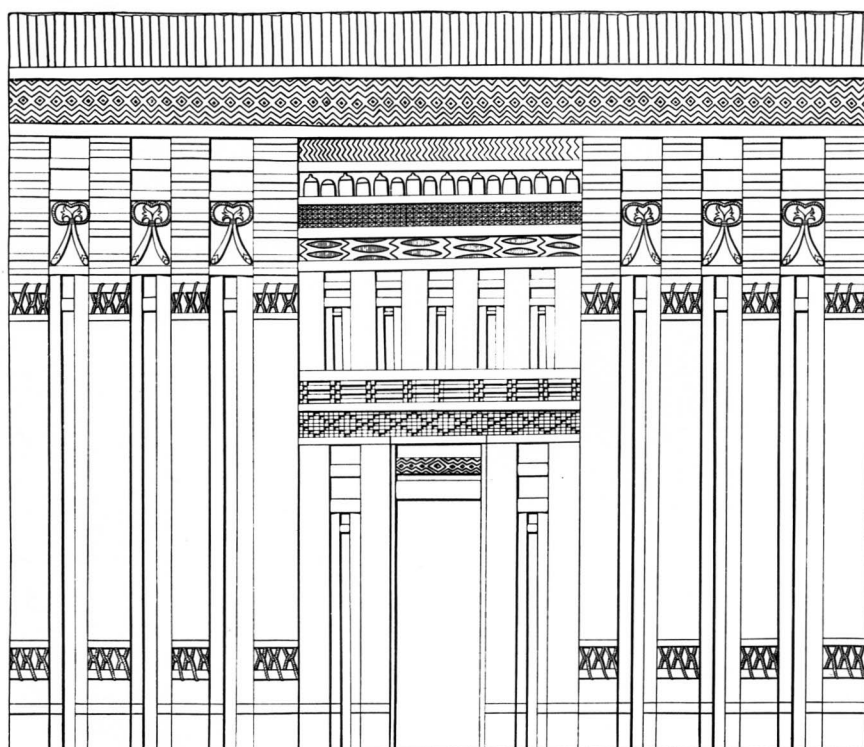

TOMB OF FIFI: SOUTH END OF THE SARCOPHAGUS



TOMB OF IŸ: THE FALLEN ARCHITRAVE BEFORE THE ENTRANCE



TOMB OF MERSU-ANKH: ENTRANCE DOORWAY



1



2



3

TOMB OF MERSU-ANKH: (1) OFFERING-TABLES ON FLOOR OF THE CHAMBER
(2) AN OFFERING-TABLE. (3) FALSE DOOR BY ENTRANCE



2



1



3



4

TOMB OF MERSU-CANKH: (1) FALSE DOOR AT END OF LEFT WALL OF CHAMBER
(2, 3, and 4) OFFERING-TABLES

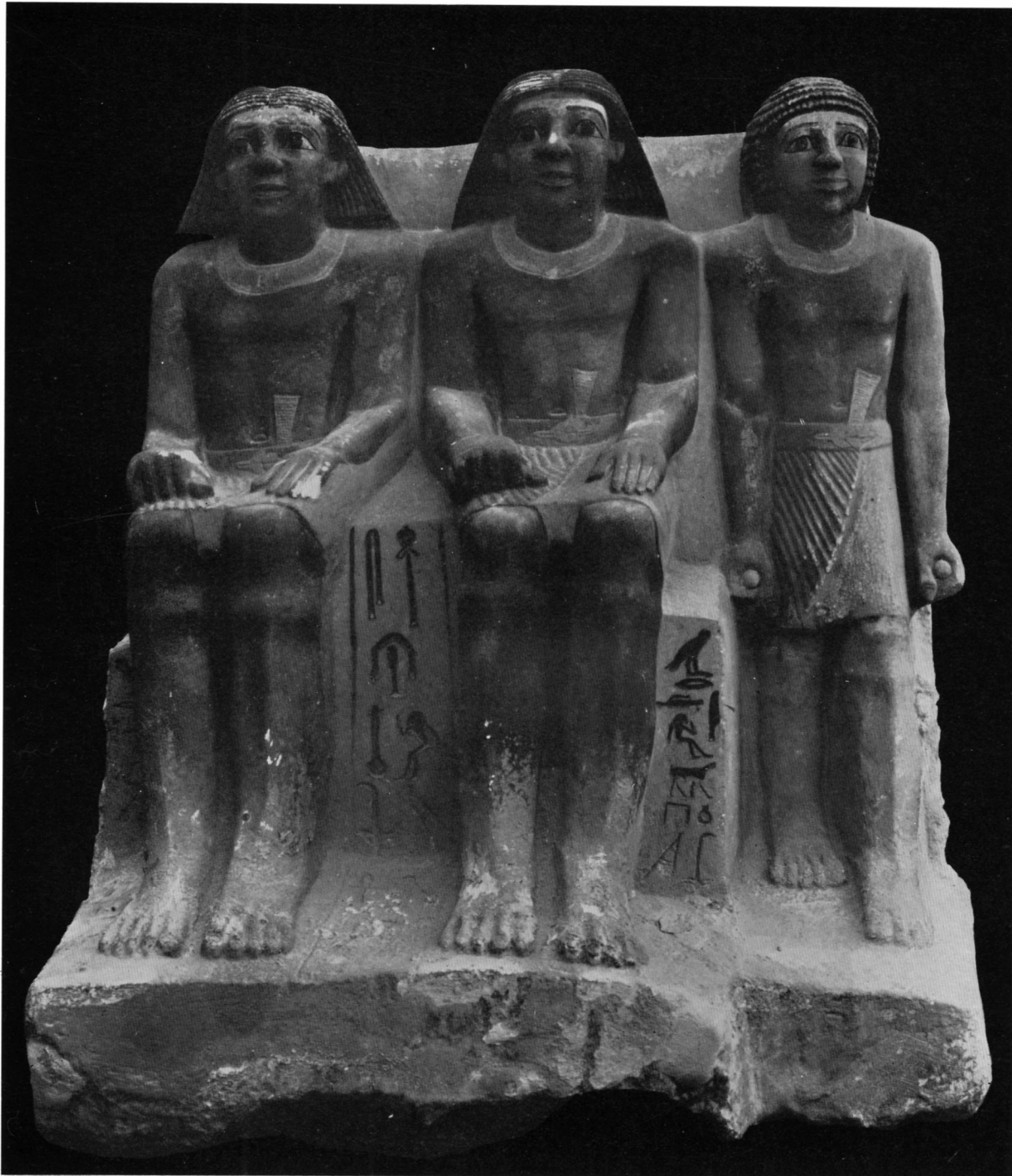

TOMB OF MERSU-CANKH: TRIPLE STATUETTE OF MERSU-CANKH



TOMB OF MERSU-ANKH: STATUETTE OF THE BREWERESS



TOMB OF MERSU-ANKH: DOUBLE STATUETTE OF MERSU-ANKH



TOMB OF MERSU-ANKH: STATUETTES OF A MAN AND WOMAN

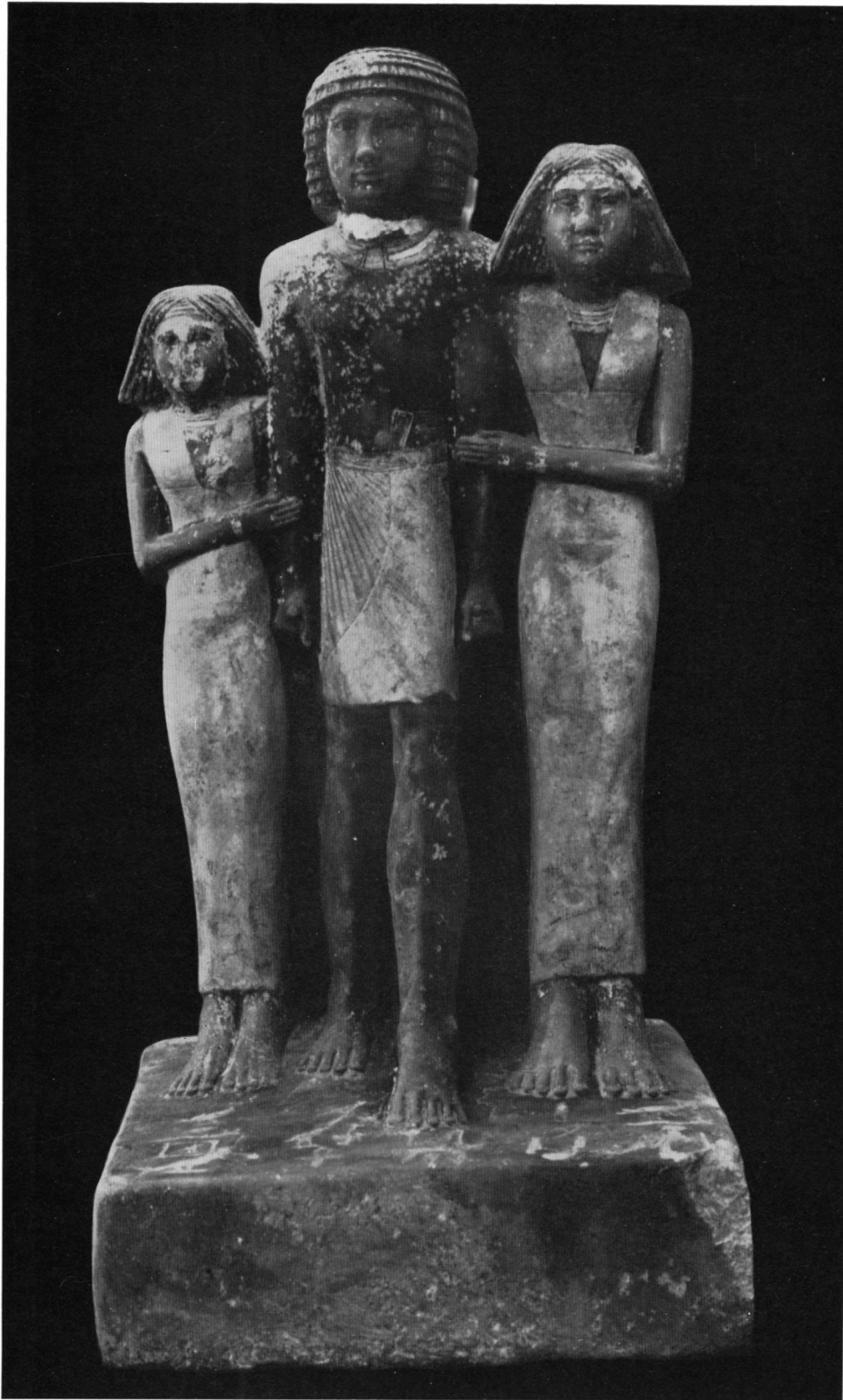

TOMB OF MERSU-ANKH: STATUETTES OF MERSU-ANKH AND
HIS DAUGHTERS



TOMB OF MERSU-ANKH: STATUETTES OF MERSU-ANKH AND HIS WIFE



TOMB OF MERSU-CANKH: STATUETTE OF A MAN



TOMB OF MERSU-ANKH: GROUP OF STATUETTES AS FOUND

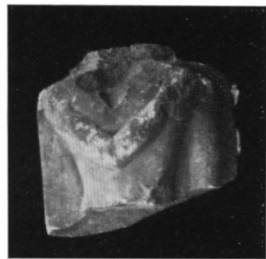

I

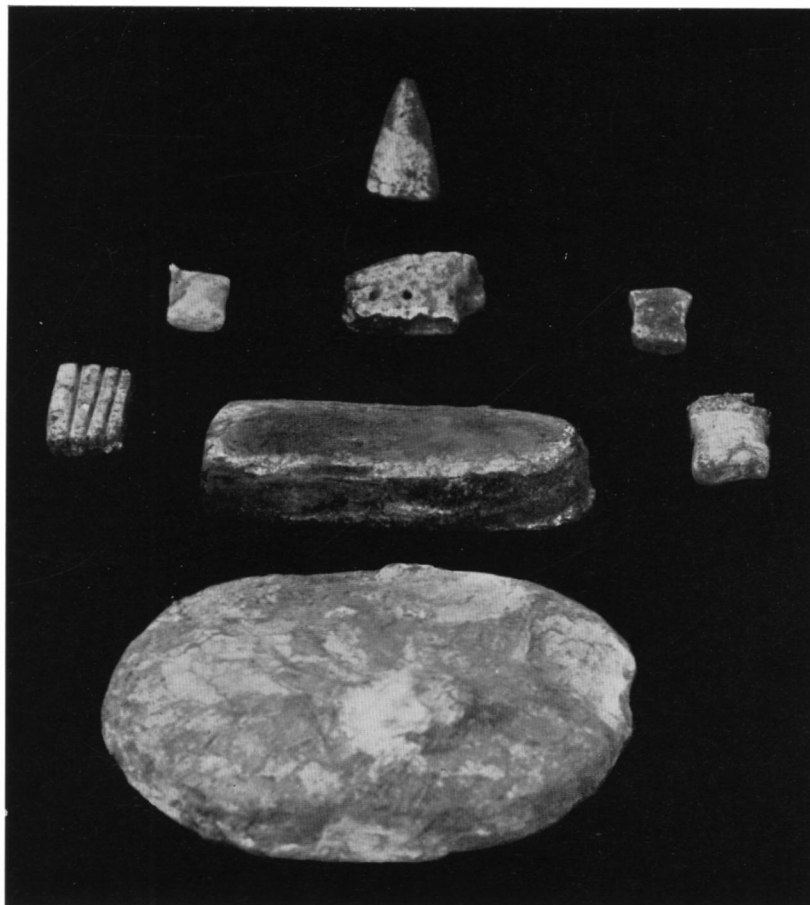

2

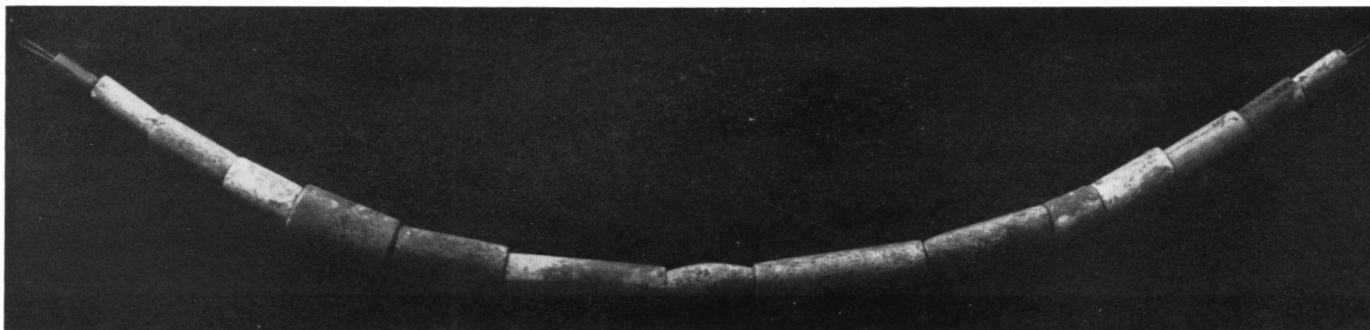

3

MISCELLANEOUS OBJECTS FROM SHAFTS
(1) TWO PIECES OF A LIMESTONE STATUETTE (2) MODEL LOAVES OF BREAD
(3) FAIENCE BEAD NECKLACE

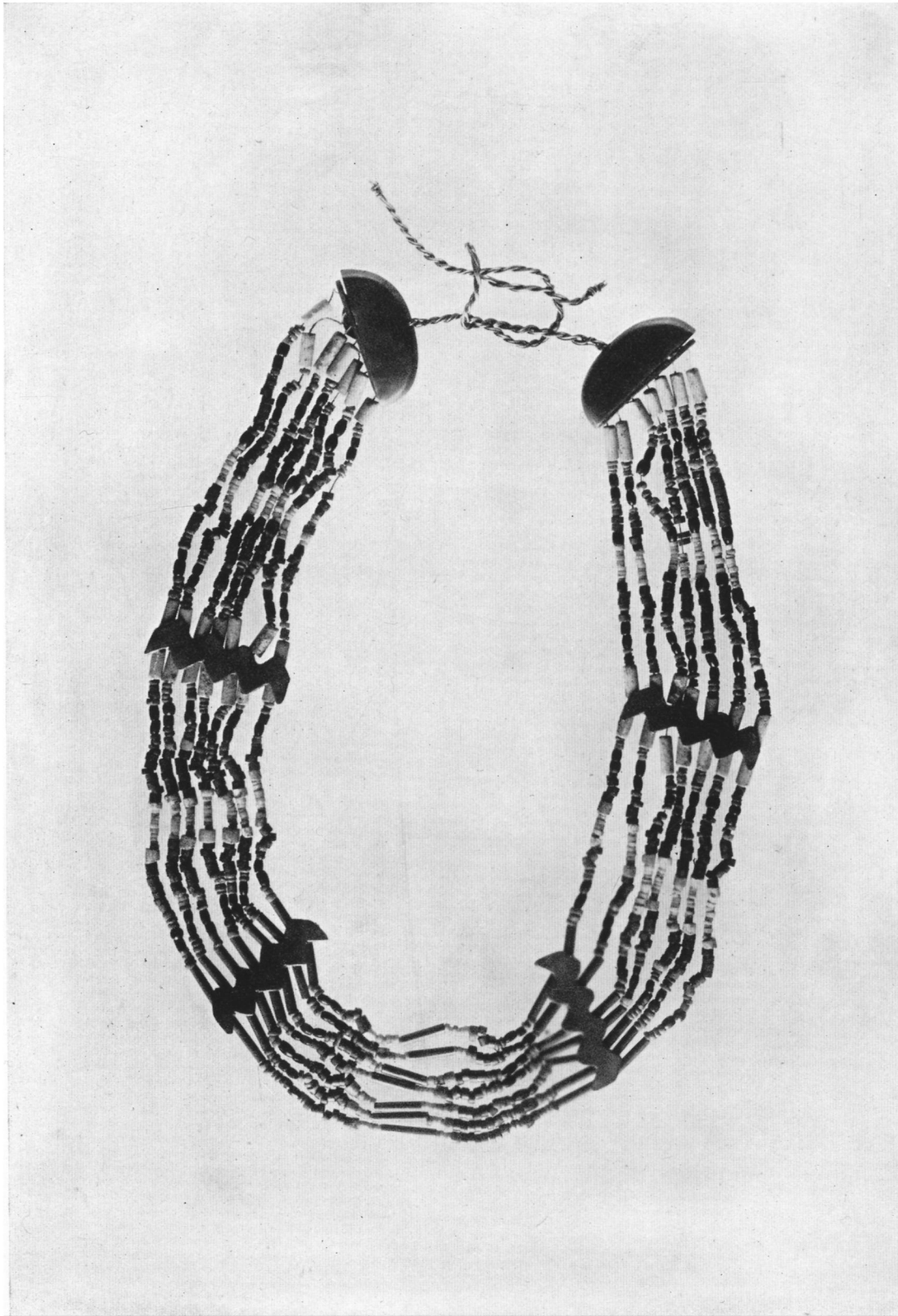

NECKLACE FOUND IN SHAFT NO. 133

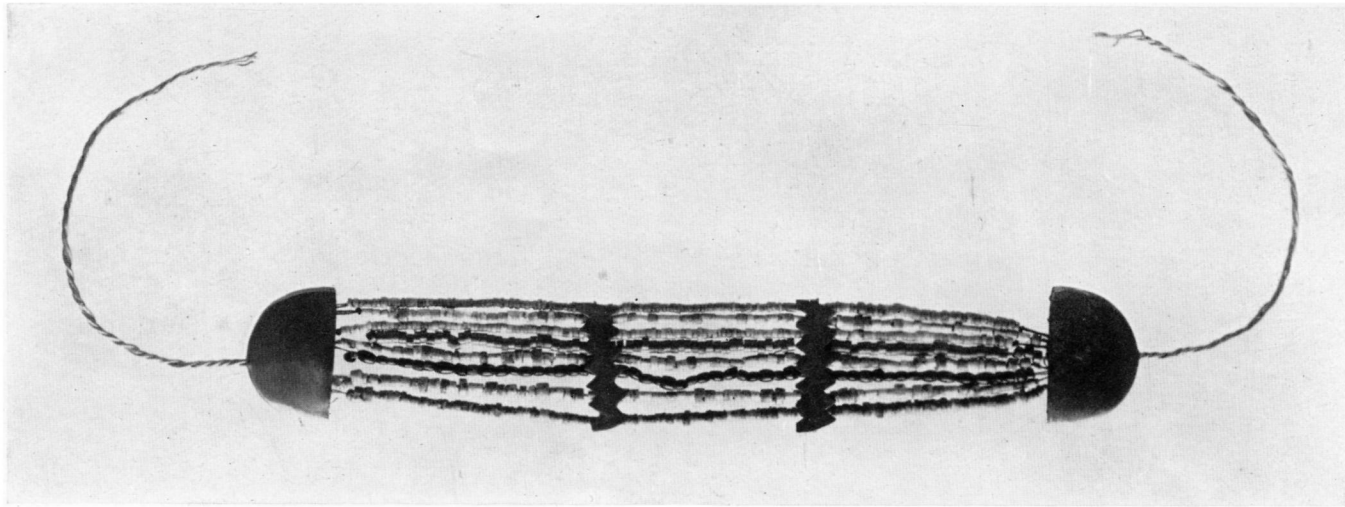

1

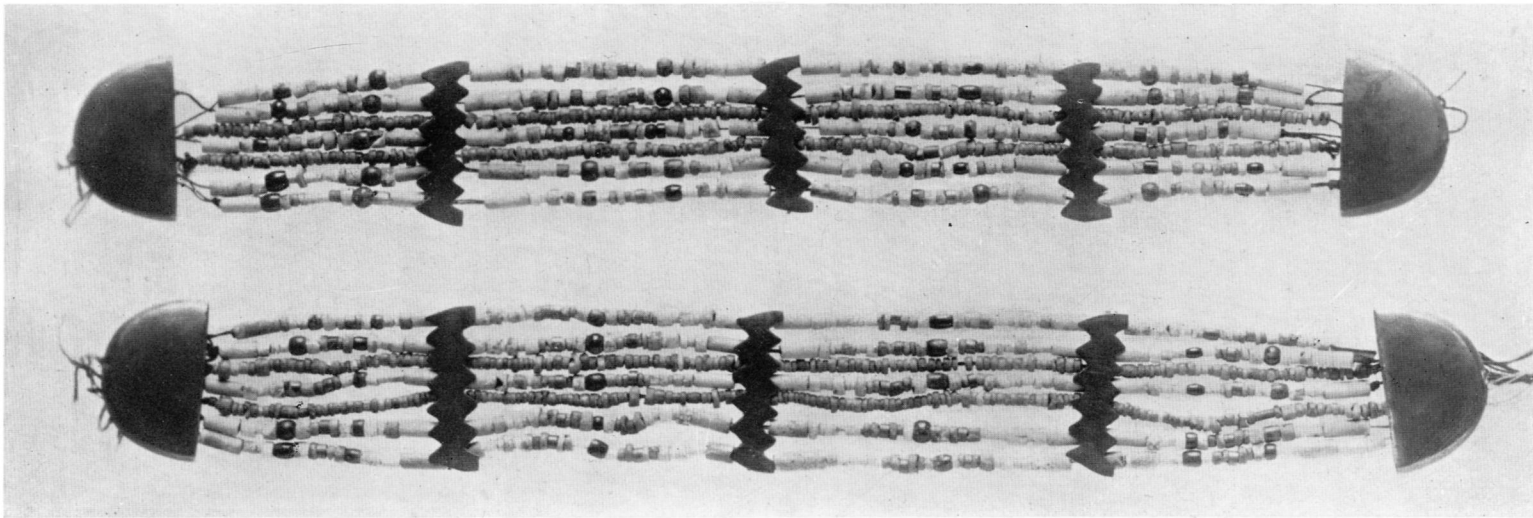

2

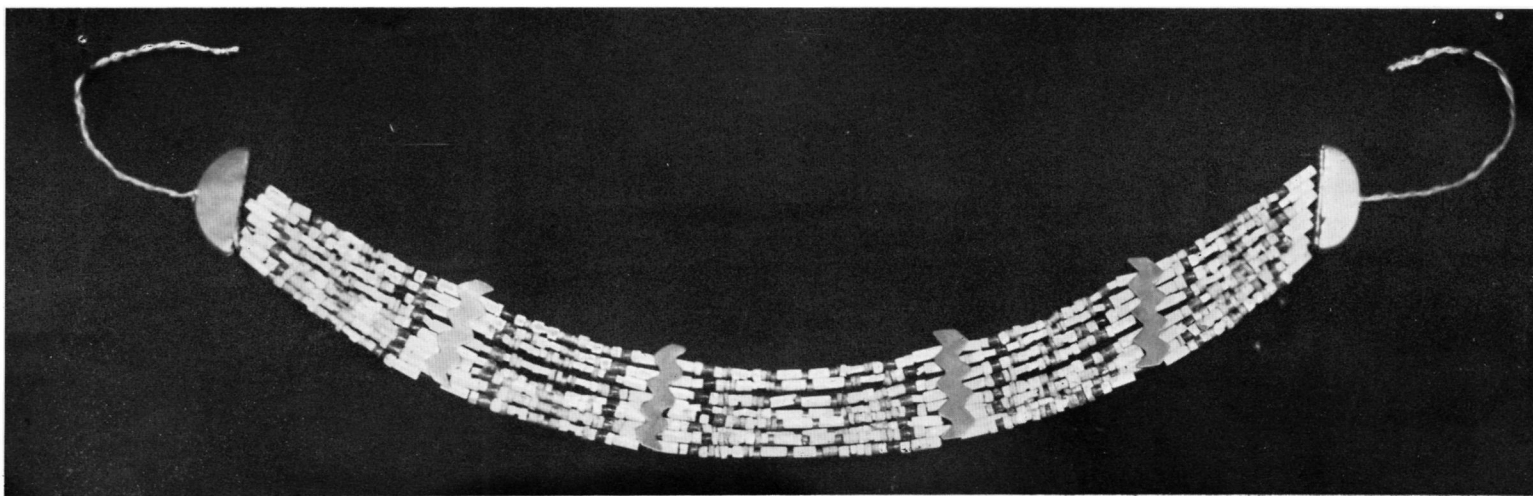

3

NECKLACES FOUND IN SHAFT NO. 133



A

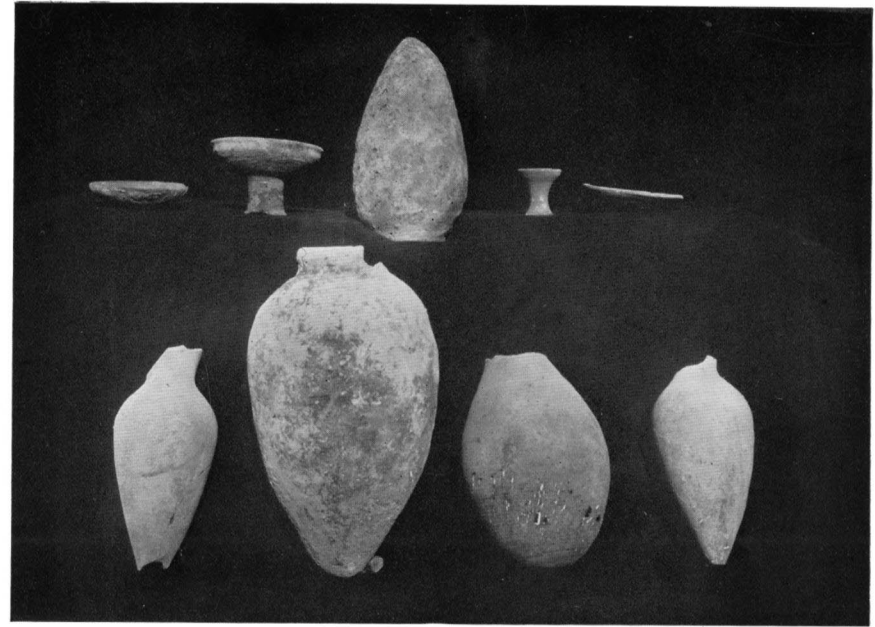

C



B



D

MISCELLANEOUS POTTERY FOUND DURING THE COURSE OF EXCAVATING

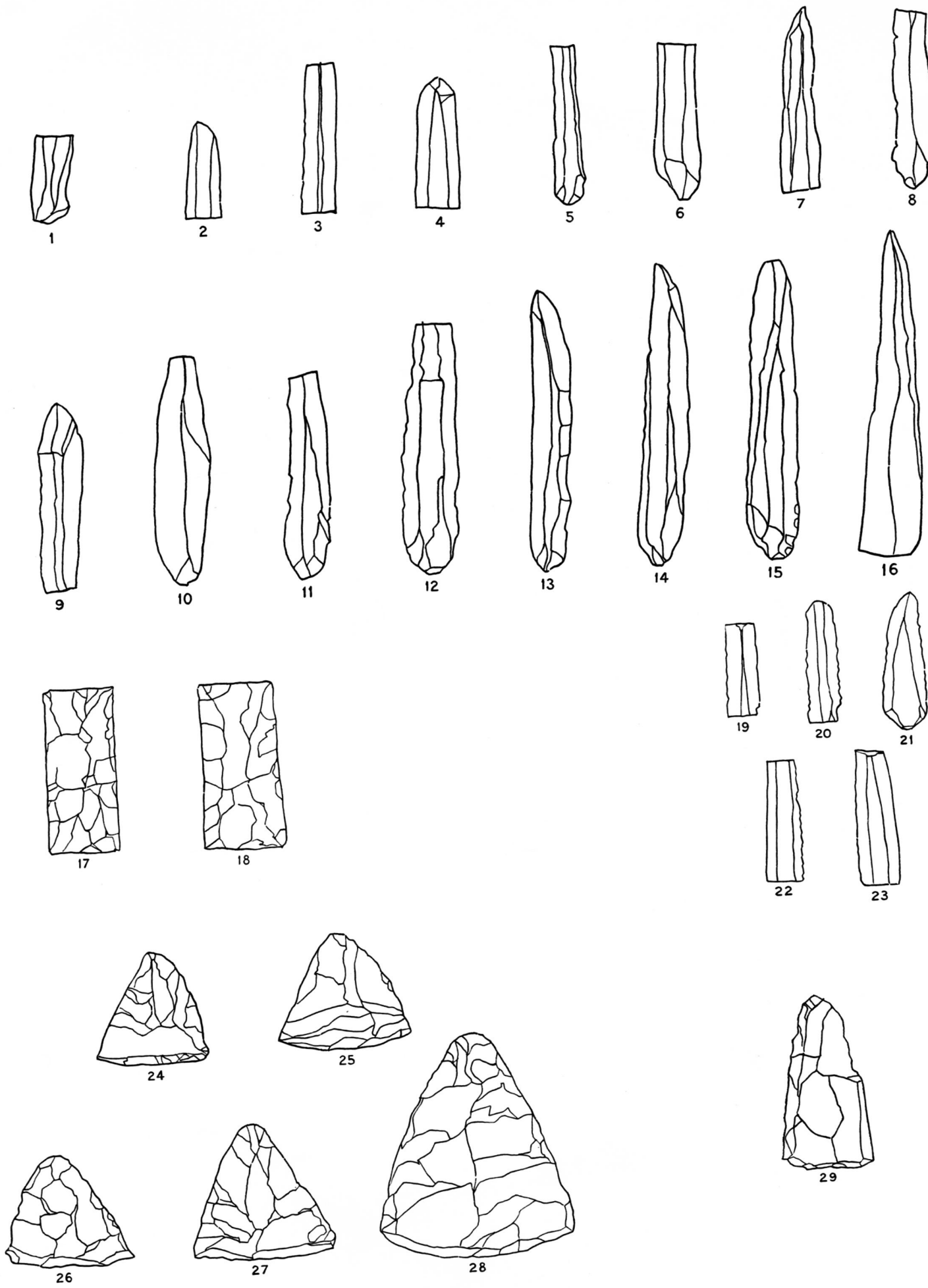

FLINT IMPLEMENTS